

ENGINEERING
TOMORROW



Technical Information

Gear Pumps

Group 4

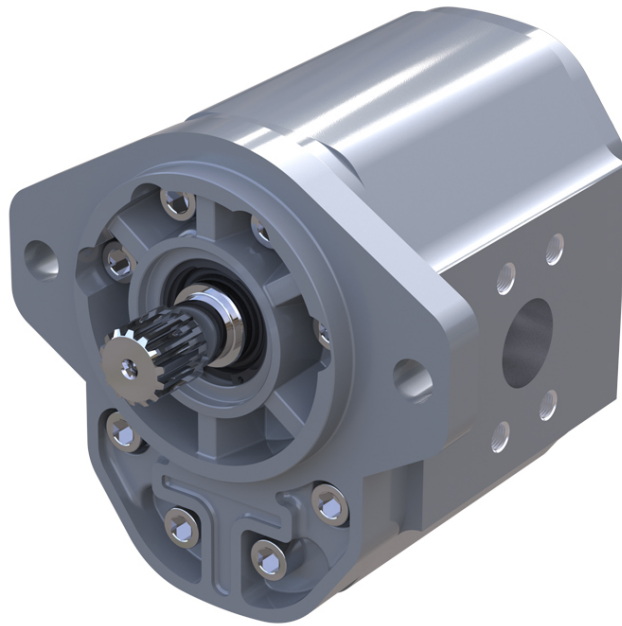

Revision history

Table of revisions

Date	Changed	Rev
October 2019	First edition	0101

Contents

General Information

Overview.....	4
Group 4 gear pumps attributes.....	4
Pump displacements.....	4
Pump design.....	5
Technical data for TAP4NN.....	5
Determination of nominal pump sizes.....	6

Product Code

Model code.....	7
A Family.....	7
B Displacement.....	7
C Rotation.....	7
D Project version.....	7
E Mounting flange.....	7
F Drive gear.....	8
G Rear cover.....	8
H Inlet size; I Outlet size.....	8
J Ports positions & Special body.....	9
K Seals.....	9
L Screws.....	9
M Set valve.....	9
N Type mark.....	9
O Mark position.....	10

System Requirements

Pressure.....	11
Speed.....	11
Hydraulic fluids.....	12
Temperature and viscosity.....	12
Filtration.....	13
Filters.....	13
Selecting a filter.....	13
Reservoir.....	13
Line sizing.....	14
Pump drive.....	14
Pump drive data form.....	15
Pump Life.....	16

Product Options

Shaft, flange, and port configurations.....	17
Mounting flanges.....	17
Shaft options.....	17
Port configurations.....	18
Porting.....	19

Dimensions

TAP4NN - 01FA, 01DA, and 01BA.....	21
TAP4NN - 02RA, and 02GA.....	22

General Information

Overview

The Danfoss Group 4 is a range of peak performance fixed-displacement gear pumps. Constructed of a high-strength extruded aluminum body with aluminum cover and flange, all pumps are pressure-balanced for exceptional efficiency.

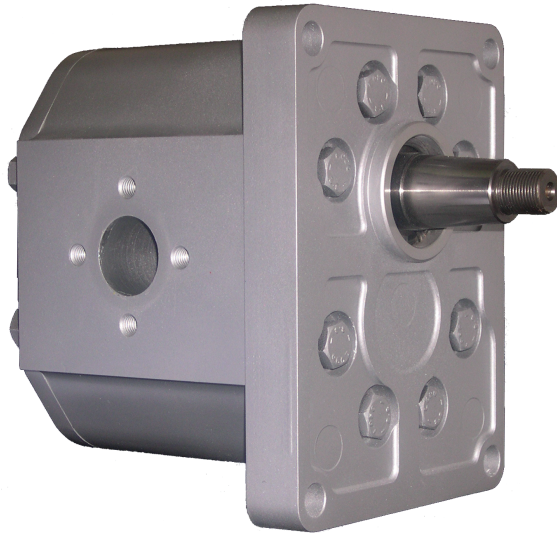

Group 4 gear pumps attributes

- Wide range of displacements from 60 to 200 cm³/rev [from 3.66 to 12.2 in³/rev]
- Continuous pressure rating up to 220 bar [3191 psi]
- Speeds up to 3000 min⁻¹ (rpm)
- SAE and European standard mounting flanges
- High quality case hardened steel gears
- Multiple pump configurations in combination with SNP1NN, SNP2NN and SNP3NN

Pump displacements

Quick reference chart for pump displacements vs. rated pressure

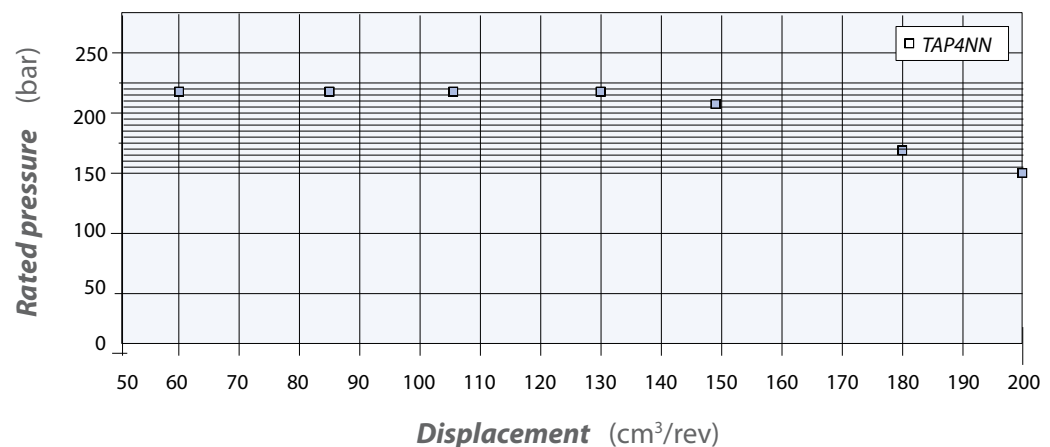

General Information

Pump design

TAP4NN

The TAP4NN gear pump is available in a displacement range from 60.0 to 200.0 cm³/rev [from 3.66 to 12.2 in³/rev]. Suitable for applications where the pressure is lower than 220 bar [3191 psi] continuous, the TAP4NN range is released into SAE and European configurations.

TAP4NN 01BA

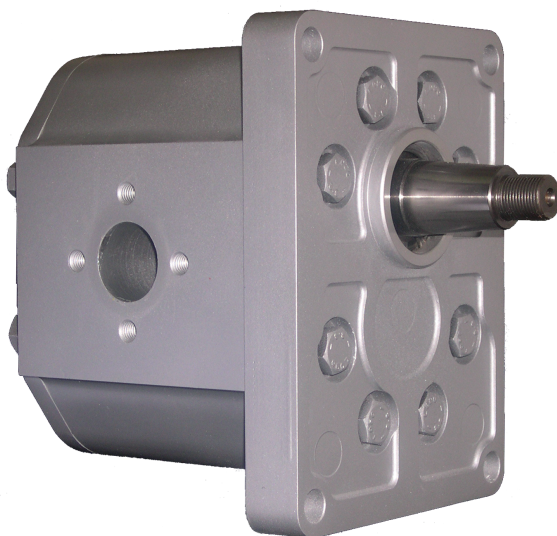

Technical data for TAP4NN

TAP4NN pump model		Frame size						
		60	85	106	130	148	180	200
Displacement	cm ³ /rev [in ³ /rev]	58.0 [3.54]	83.3 [5.08]	103.4 [6.31]	126.1 [7.69]	143.8 [8.77]	174.1 [10.62]	194.3 [11.86]
Peak pressure	bar [psi]	230 [3335]	230 [3335]	230 [3335]	230 [3335]	220 [3190]	180 [2610]	160 [2320]
Rated pressure		220 [3190]	220 [3190]	220 [3190]	220 [3190]	210 [3045]	170 [2465]	150 [2175]
Minimum speed	min ⁻¹ (rpm)	650	650	600	550	500	500	480
Maximum speed		3000	3000	2500	2500'	2400	2400	2400
Weight	kg [lb]	13.45 [29.65]	14.4 [31.75]	14.9 [32.85]	15.75 [34.72]	17.2 [37.92]	17.25 [38.03]	18 [39.68]
Moment of inertia of rotating components	x 10 ⁻⁶ kg·m ² [x 10 ⁻⁶ lbf·ft ²]	682,7 16193,6	839 19901,1	965,2 22894,5	1106,5 26246,2	1216,4 28853,0	1216,4 28853,0	1530,3 36298,7
Theoretical flow at maximum speed	l/min [US gal/min]	174.0 [46.0]	249.9 [66.0]	258.5 [68.3]	315.2 [83.3]	345.1 [91.2]	417.8 [110.4]	466.3 [123.2]

Caution

The rated and peak pressure mentioned are for pumps with flanged ports only. When threaded ports are required a derated performance must be considered. To verify the compliance of an high pressure application with a threaded ports pump apply to a Danfoss representative.

General Information

Determination of nominal pump sizes

Use these formula to determine the nominal pump size for a specific application:

Based on SI units

Based on US units

Output flow: $Q = \frac{Vg \cdot n \cdot \eta_v}{1000} \text{ l/min}$

$Q = \frac{Vg \cdot n \cdot \eta_v}{231} \text{ [US gal/min]}$

Input torque: $M = \frac{Vg \cdot \Delta p}{20 \cdot \pi \cdot \eta_m} \text{ N}\cdot\text{m}$

$M = \frac{Vg \cdot \Delta p}{2 \cdot \pi \cdot \eta_m} \text{ [lbf}\cdot\text{in]}$

Input power: $P = \frac{M \cdot n}{9550} = \frac{Q \cdot \Delta p}{600 \cdot \eta_t} \text{ kW}$

$P = \frac{M \cdot n}{63.025} = \frac{Q \cdot \Delta p}{1714 \cdot \eta_t} \text{ [hp]}$

$Vg =$	Displacement per rev.	cm ³ /rev [in ³ /rev]
$P_{HD} =$	Outlet pressure	bar [psi]
$P_{ND} =$	Inlet pressure	bar [psi]
$\Delta p =$	$P_{HD} - P_{ND}$	bar [psi]
$n =$	Speed	min ⁻¹ (rpm)
$\eta_v =$	Volumetric efficiency	
$\eta_m =$	Mechanical (torque) efficiency	
$\eta_t =$	Overall efficiency ($\eta_v \cdot \eta_m$)	

Product Code

Model code

A Family

A						B	C	D	E	F	G	H	I	J	K	L	M	N	O	
•	•	•	•	•	•	/											/			

TAP4NN	Group 4 pumps from 60 up to 200 cc
---------------	------------------------------------

B Displacement

A						B	C	D	E	F	G	H	I	J	K	L	M	N	O	
						/	•	•	•								/			

060	58 cc
085	83,3 cc
106	103,4 cc
130	126,1 cc
148	143,8 cc
180	174,1 cc
200	194,3 cc

C Rotation

A						B	C	D	E	F	G	H	I	J	K	L	M	N	O
						/		•								/			

L	Left rotation
R	Right rotation

D Project version

A						B	C	D	E	F	G	H	I	J	K	L	M	N	O
						/		•								/			

N	Std Version of Project
----------	------------------------

E Mounting flange

A						B	C	D	E	F	G	H	I	J	K	L	M	N	O
						/			•	•						/			

Code	Description (Type of flange • Type of drive gear • Preferred ports for configuration)
01	European 4 bolt - Pilot Ø63,5
02	SAE C 2 bolt - Pilot Ø127
F1	European 4 bolt - Pilot Ø63,5 (special FIAT-ALLIS)

Product Code

F Drive gear

A				/	B				C	D	E	F		G	H	I	J	K	L	/	M	N	O
				/								•	•							/			

BA	Taper 1:8-M20x1,5-Key 6,375
DA	Spline DIN 5482 B35x31xL44
FA	Parallel Ø30-Key 8x7xL50
GA	Parallel Ø31,75-Key 7,962x7x36
RA	Splined-SAE J498-14T-12/24-SAE C 2 bolt

G Rear cover

A				/	B				C	D	E	F	G		H	I	J	K	L	/	M	N	O
				/									•	•						/			

P1	Standard cover for pump
-----------	-------------------------

H Inlet size; I Outlet size

A				/	B				C	D	E	F	G	H	I	J	K	L	/	M	N	O		
				/										•	•	•	•				/			

A4	31x30,18x58,72x7/16-14UNC	
A5	37,5x35,71x69,85x1/2-13UNC	
A6	50x42,88x77,77x1/2-13UNC	
CB	30x56xM10	
CC	32x62xM10	
CD	36x62xM10	
CE	32x62xM12	
CF	38x72,5xM12	
CG	40x72,5xM12	
CH	45x72,5xM12	
CK	48x72,5xM12	
CL	56x92xM12	

F7	1-1/4 GAS	
F8	1-1/2 GAS	
F9	1-3/4 GAS	

Product Code

GE	32x62x7/16-14UNC	
GF	38x72,5x1/2-13UNC	
GK	48x72,5x1/2-13UNC	

J Ports positions & Special body

A	B	C	D	E	F	G	H	I	J	K	L	M	N	O
									•	•		/		

NN	Std position from catalogue
SD	Body width side ports=151mm (Std for O2 Flange)
G9	Ports distance from flange=79 - Special
I5	Ports distance from flange =95 - Special
L0	Ports distance from flange =100 - Special
LI	Ports distance from flange =104,5 - Special

K Seals

A	B	C	D	E	F	G	H	I	J	K	L	M	N	O
										•	/			

N	Standard NBR seals
----------	--------------------

L Screws

A	B	C	D	E	F	G	H	I	J	K	L	M	N	O
											•	/		

N	Std burnished screws
----------	----------------------

M Set valve

A	B	C	D	E	F	G	H	I	J	K	L	M	N	O
											/	•	•	•

NNN	No valve
------------	----------

N Type mark

A	B	C	D	E	F	G	H	I	J	K	L	M	N	O
											/			•

N	Standard Danfoss Marking
A	Standard Danfoss Marking+Customer Code
Z	Without Marking

Product Code

O Mark position

A					B	C	D	E	F	G	H	I	J	K	L		M	N	O	
				/												/				•

N	Std Marking position (on top)
A	Special Marking position on the bottom

System Requirements

Pressure

The inlet vacuum must be controlled in order to realize expected pump life and performance. The system design must meet inlet pressure requirements during all modes of operation. Expect lower inlet pressures during cold start. It should improve quickly as the fluid warms.

Max. continuous vacuum	bar abs. [in. Hg]	0.8 [23.6]
Max. intermittent vacuum		0.6 [17.7]
Max. pressure		3.0 [88.5]

Peak pressure is the highest intermittent pressure allowed. The relief valve overshoot (reaction time) determines peak pressure. It is assumed to occur for less than 100 ms. The accompanying illustration shows peak pressure in relation to rated pressure and reaction time (100 ms maximum).

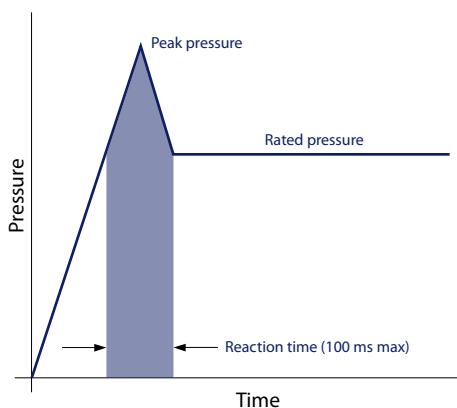

Rated pressure is the average, regularly occurring, operating pressure that should yield satisfactory product life. The maximum machine load demand determines rated pressure. For all systems, the load should move below this pressure.

System pressure is the differential of pressure between the outlet and inlet ports. It is a dominant operating variable affecting hydraulic unit life. High system pressure, resulting from high load, reduces expected life. System pressure must remain at, or below, rated pressure during normal operation to achieve expected life.

Speed

Maximum speed is the limit recommended by Danfoss for a particular gear pump when operating at rated pressure. It is the highest speed at which normal life can be expected.

The lower limit of operating speed is the **minimum speed**. It is the lowest speed at which normal life can be expected. The minimum speed increases as operating pressure increases. When operating under higher pressures, a higher minimum speed must be maintained, as illustrated here.

System Requirements

Speed versus pressure

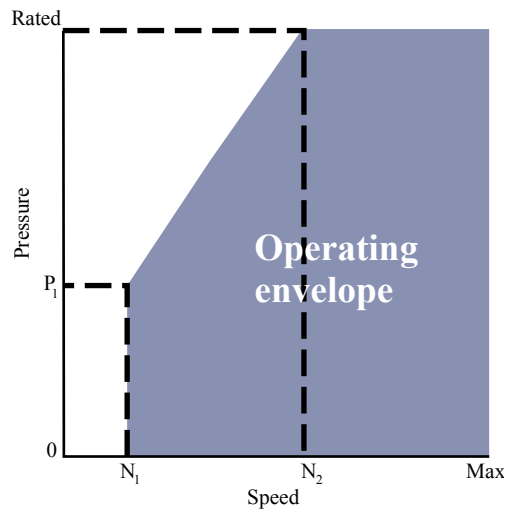

Where:

N_1 = Minimum speed at 100 bar

N_2 = Minimum speed at 180 bar

Hydraulic fluids

Ratings and data for TAP4NN gear pumps are based on operating with premium hydraulic fluids containing oxidation, rust, and foam inhibitors. These fluids must possess good thermal and hydrolytic stability to prevent wear, erosion, and corrosion of internal components. They include:

- Hydraulic fluids following DIN 51524, part 2 (HLP) and part 3 (HVL) specifications
- API CD engine oils conforming to SAE J183
- M2C33F or G automatic transmission fluids
- Certain agricultural tractor fluids

Use only clean fluid in the pump and hydraulic circuit.

Caution

Never mix hydraulic fluids.

Temperature and viscosity

Temperature and viscosity requirements must be concurrently satisfied. Use petroleum / mineral-based fluids.

High temperature limits apply at the inlet port to the pump. The pump should run at or below the maximum continuous temperature. The peak temperature is based on material properties. Don't exceed it.

Cold oil, generally, doesn't affect the durability of pump components. It may affect the ability of oil to flow and transmit power. For this reason, keep the temperature at 16 °C [60 °F] above the pour point of the hydraulic fluid.

Minimum (cold start) temperature relates to the physical properties of component materials.

Minimum viscosity occurs only during brief occasions of maximum ambient temperature and severe duty cycle operation. You will encounter maximum viscosity only at cold start. During this condition, limit speeds until the system warms up. Size heat exchangers to keep the fluid within these limits. Test regularly to verify that these temperatures and viscosity limits aren't exceeded. For maximum unit efficiency and bearing life, keep the fluid viscosity in the recommended viscosity range.

System Requirements

Fluid viscosity

Maximum (cold start)	mm ² /s [SUS]	1000 [4600]
Recommended range		12-60 [66-290]
Minimum		10 [60]

Temperature

Minimum (cold start)	°C [°F]	-20 [-4]
Maximum continuous		80 [176]
Peak (intermittent)		90 [194]

Filtration

Filters

Use a filter that conforms to Class 22/18/13 of ISO 4406 (or better). It may be on the pump outlet (pressure filtration), inlet (suction filtration), or reservoir return (return-line filtration).

Selecting a filter

When selecting a filter, please consider:

- contaminant ingress rate (determined by factors such as the number of actuators used in the system)
- generation of contaminants in the system
- required fluid cleanliness
- desired maintenance interval
- filtration requirements of other system components

Measure filter efficiency with a Beta ratio (β_x). For:

- suction filtration, with controlled reservoir ingress, use a $\beta_{35-45} = 75$ filter
- return or pressure filtration, use a pressure filtration with an efficiency of $\beta_{10} = 75$

β_x ratio is a measure of filter efficiency defined by ISO 4572. It is the ratio of the number of particles greater than a given diameter ("x" in microns) upstream of the filter to the number of these particles downstream of the filter.

Fluid cleanliness level and β_x ratio

Fluid cleanliness level (per ISO 4406)	Class 22/18/13 or better
β_x ratio (suction filtration)	$\beta_{35-45} = 75$ and $\beta_{10} = 2$
β_x ratio (pressure or return filtration)	$\beta_{10} = 75$
Recommended inlet screen size	100-125 μ m [0.004-0.005 in]

The filtration requirements for each system are unique. Evaluate filtration system capacity by monitoring and testing prototypes.

Reservoir

The **reservoir** provides clean fluid, dissipates heat, removes entrained air, and allows fluid volume changes associated with fluid expansion and cylinder differential volumes. A correctly sized reservoir accommodates maximum volume changes during all system operating modes. It promotes deaeration of the fluid as it passes through, and accommodates a fluid dwell-time between 60 and 180 seconds, allowing entrained air to escape.

System Requirements

Minimum reservoir capacity depends on the volume required to cool and hold the oil from all retracted cylinders, allowing for expansion due to temperature changes. A fluid volume of 1 to 3 times the pump output flow (per minute) is satisfactory. The minimum reservoir capacity is 125% of the fluid volume.

Install the suction line above the bottom of the reservoir to take advantage of gravity separation and prevent large foreign particles from entering the line. Cover the line with a 100-125 micron screen. The pump should be below the lowest expected fluid level. Put the return-line below the lowest expected fluid level to allow discharge into the reservoir for maximum dwell and efficient deaeration. A baffle (or baffles) between the return and suction lines promotes deaeration and reduces fluid surges.

Line sizing

Choose pipe sizes that accommodate minimum fluid velocity to reduce system noise, pressure drops, and overheating. This maximizes system life and performance.

Design inlet piping that maintains continuous pump inlet pressure above 0.8 bar absolute during normal operation. The line velocity should not exceed the values in this table:

Maximum line velocity

Inlet	m/s [ft/sec]	2.5 [8.2]
Outlet		5.0 [16.4]
Return		3.0 [9.8]

Most systems use hydraulic oil containing 10% dissolved air by volume. Under high inlet vacuum conditions the oil releases bubbles. They collapse when subjected to pressure, resulting in cavitation, causing adjacent metal surfaces to erode. **Over-aeration** is the result of air leaks on the inlet side of the pump, and flow-line restrictions. These include inadequate pipe sizes, sharp bends, or elbow fittings, causing a reduction of flow line cross sectional area. This problem will not occur if inlet vacuum and rated speed requirements are maintained, and reservoir size and location are adequate.

Pump drive

Shaft options for Group 4 gear pumps include tapered, splined, or parallel shafts. They are suitable for a wide range of direct and indirect drive applications for radial and thrust loads.

Plug-in drives, acceptable only with a splined shaft, can impose severe radial loads when the mating spline is rigidly supported. Increasing spline clearance does not alleviate this condition.

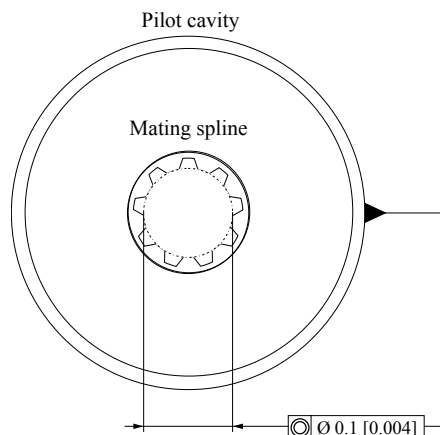

Use **plug-in drives** if the concentricity between the mating spline and pilot diameter is within 0.1 mm [0.004 in]. Lubricate the drive by flooding it with oil. A 3-piece coupling minimizes radial or thrust shaft loads.

System Requirements

! Caution

In order to avoid spline shaft damages it is recommended to use carburized and hardened steel couplings with 80-82 HRA surface hardness.

Allowable **radial shaft loads** are a function of the load position, load orientation, and operating pressure of the hydraulic pump. All external shaft loads have an effect on bearing life, and may affect pump performance.

In applications where external shaft loads can't be avoided, minimize the impact on the pump by optimizing the orientation and magnitude of the load. Use a tapered input shaft; don't use splined shafts for belt or gear drive applications. A spring-loaded belt tension-device is recommended for belt drive applications to avoid excessive tension. Avoid thrust loads in either direction.

Pump drive data form

Contact Danfoss if continuously applied external radial or thrust loads occur. Fill out this page and send the complete form to your Danfoss representative for an assistance in applying pumps with belt or gear drive. This illustration shows a pump with counterclockwise orientation:

Optimal radial load position

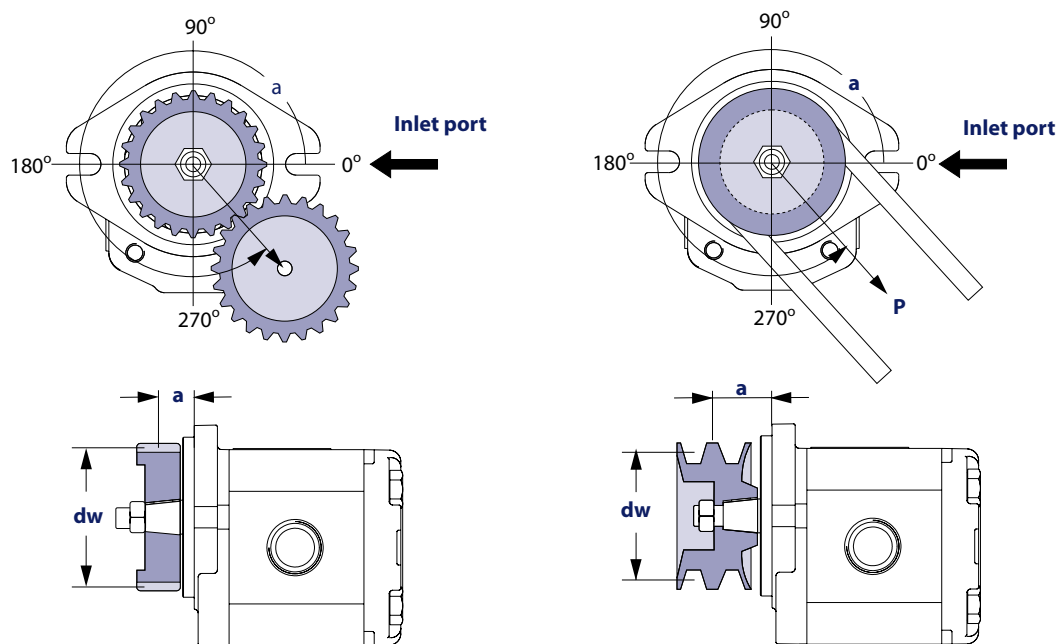

Application data

Item	Value	Unit
Pump displacement		cm ³ /rev [in ³ /rev]
Rated system pressure		bar psi
Relief valve setting		
Pump shaft rotation		left right
Pump minimum speed		min ⁻¹ (rpm)
Pump maximum speed		
Drive gear helix angle (gear drive only)		degree
Belt type (gear drive only)		V notch
Belt tension (gear drive only)	P	N lbf

System Requirements

Application data (continued)

Item		Value	Unit
Angular orientation of gear or belt to inlet port	α		degree
Pitch diameter of gear or pulley	dw		mm in
Distance from flange to center of gear or pulley	a		

Pump Life

Pump life is a function of speed, system pressure, and other system parameters (such as fluid quality and cleanliness).

All Danfoss gear pumps use hydrodynamic journal bearings that have an oil film maintained between the gear/shaft and bearing surfaces at all times. If the oil film is sufficiently sustained through proper system maintenance and operating within recommended limits, long life can be expected.

[B₁₀ life expectancy number is generally associated with rolling element bearings. It does not exist for hydrodynamic bearings.](#)

High pressure, resulting from high loads, impacts pump life. When submitting an application for review, provide machine duty cycle data that includes percentages of time at various loads and speeds. We strongly recommend a prototype testing program to verify operating parameters and their impact on life expectancy before finalizing any system design.

Product Options

Shaft, flange, and port configurations

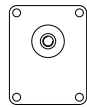
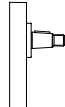
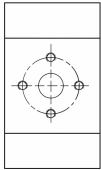
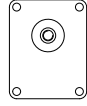
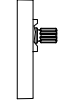
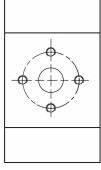
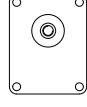
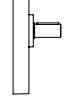
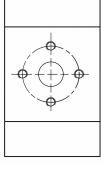
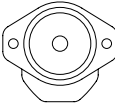
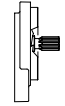
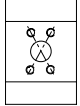
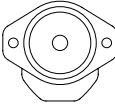
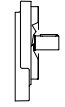
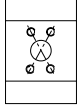
Motor	Code	Flange		Shaft		Port	
TAP4NN	01BA	pilot Ø 63.5 mm [2.5 in] European 01, 4-bolt		1:8 tapered		European flanged port + pattern	
TAP4NN	01DA	pilot Ø 63.5 mm [2.5 in] European 01, 4-bolt		Spline DIN 5482 B35x31xL44		European flanged port + pattern	
TAP4NN	01FA	pilot Ø 63.5 mm [2.5 in] European 01, 4-bolt		Parallel Ø30-Key 8x7xL50		European flanged port + pattern	
TAP4NN	02RA	pilot Ø 127 mm [5.0 in] SAE C, 2-bolt		Splined-SAE J498-14T		Vertical four bolt flanged port	
TAP4NN	02GA	pilot Ø 127 mm [5.0 in] SAE C, 2-bolt		Parallel Ø31,75-Key 7,962x7x36		Vertical four bolt flanged port	

Mounting flanges

Danfoss offers many types of industry standard mounting flanges. This table shows order codes for each available mounting flange and its intended use:

A	B	C	D	E	F	G	H	I	J	K	L	M	N	O
				•	•							/		

Code	Description
01	European 4 bolt - PilotØ63,5
02	SAE C 2 bolt - Pilot Ø127
F1	European 4 bolt - Pilot Ø63,5 (special FIAT-ALLIS)

Shaft options

Direction is viewed facing the shaft. Group 4 pumps are available with a variety of splined, parallel, and tapered shaft ends. Not all shaft styles are available with all flange styles.

A	B	C	D	E	F	G	H	I	J	K	L	M	N	O
					•	•						/		

Product Options

Shaft		Mounting flange code with maximum torque in Nm [lb-in]	
Code	Description	01	02
BA	Taper 1:8-M20x1,5-Key 6,375	970 [8585]	
DA	Spline DIN 5482 B35x31xL44	850 [7523]	
FA	Parallel Ø30-Key 8x7xL50	710 [6284]	
GA	Parallel Ø31,75-Key 7,962x7x36		750 [6638]
RA	Splined-SAE J498-14T-12/24-SAE C 2 bolt		800 [7080]

Danfoss recommends mating splines conform to SAE J498 or DIN 5482. Danfoss external SAE splines have a flat root side fit with circular tooth thickness reduced by 0.127 mm [0.005 in] in respect to class 1 fit. Dimensions are modified to assure a clearance fit with the mating spline.

! Caution

Shaft torque capability may limit allowable pressure. Torque ratings assume no external radial loading. Applied torque must not exceed these limits, regardless of stated pressure parameters. Maximum torque ratings are based on shaft torsional fatigue strength.

Port configurations

Various port configurations are available on Group 4 pumps. They include:

- SAE split flange ports
- European standard flanged ports
- Gas threaded ports (BSPP)

For a table of dimensions see [Porting](#) on page 19.

Available port configurations

A	B	C	D	E	F	G	H	I	J	K	L	M	N	O
/							•	•	•	•	/			

Code	Description	
A4	31x30,18x58,72x7/16-14UNC	SAE flanged port
A5	37,5x35,71x69,85x1/2-13UNC	
A6	50x42,88x77,77x1/2-13UNC	
CB	30x56xM10	Flanged port with thd holes in + pattern
CC	32x62xM10	
CD	36x62xM10	
CE	32x62xM12	
CF	38x72,5xM12	
CG	40x72,5xM12	
CH	45x72,5xM12	
CK	48x72,5xM12	
CL	56x92xM12	

Product Options

F7	1-1/4 GAS	Threaded GAS (BSPP)
F8	1-1/2 GAS	
F9	1-3/4 GAS	
GE	32x62x7/16-14UNC	Flanged port with the holes in + pattern UN thread
GF	38x72,5x1/2-13UNC	
GK	48x72,5x1/2-13UNC	

Porting

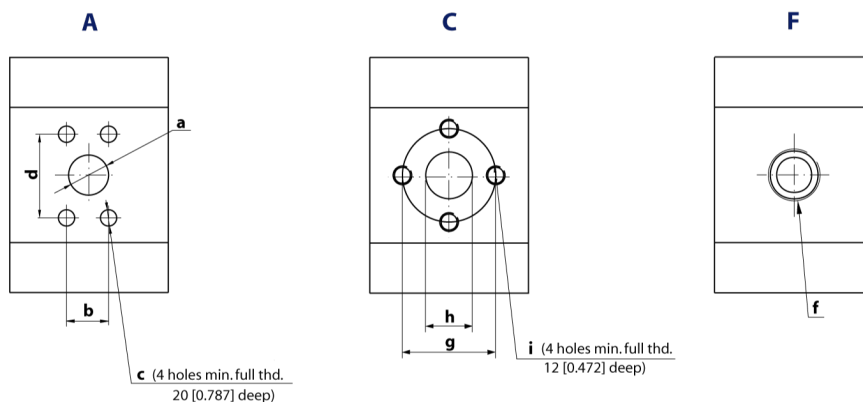

Product Options

Ports dimensions

Port type			A				C			E
Dimensions			a	b	d	c	g	h	i	f
Type (displacement)	060	Inlet	38.1 [1.5]	35.71 [1.4]	69.85 [2.75]	1/2 -13 UNC	62 [2.44]	36 [1.42]	M10	1-1/2 Gas (BSPP)
		Outlet	31.8 [1.25]	30.18 [1.19]	58.72 [2.31]	7/16 - 14UNC	56 [2.2]	30 [1.18]	M10	1-1/4 Gas (BSPP)
	085	Inlet	38.1 [1.5]	35.71 [1.4]	69.85 [2.75]	1/2 -13 UNC	62 [2.44]	36 [1.42]	M10	1-1/2 Gas (BSPP)
		Outlet	31.8 [1.25]	30.18 [1.19]	58.72 [2.31]	7/16 - 14UNC	56 [2.2]	30 [1.18]	M10	1-1/4 Gas (BSPP)
	106	Inlet	50.8 [2.0]	42.88 [1.69]	77.77 [3.06]	1/2 -13 UNC	62 [2.44]	36 [1.42]	M10	1-1/2 Gas (BSPP)
		Outlet	38.1 [1.5]	35.71 [1.4]	69.85 [2.75]	1/2 -13 UNC	56 [2.2]	30 [1.18]	M10	1-1/4 Gas (BSPP)
	130	Inlet	50.8 [2.0]	42.88 [1.69]	77.77 [3.06]	1/2 -13 UNC	72.5 [2.85]	45 [1.77]	M12	1-3/4 Gas (BSPP)
		Outlet	38.1 [1.5]	35.71 [1.4]	69.85 [2.75]	1/2 -13 UNC	62 [2.44]	36 [1.42]	M10	1-1/2 Gas (BSPP)
	148	Inlet	50.8 [2.0]	42.88 [1.69]	77.77 [3.06]	1/2 -13 UNC	72.5 [2.85]	45 [1.77]	M12	1-3/4 Gas (BSPP)
		Outlet	38.1 [1.5]	35.71 [1.4]	69.85 [2.75]	1/2 -13 UNC	62 [2.44]	36 [1.42]	M10	1-1/2 Gas (BSPP)
	180	Inlet	50.8 [2.0]	42.88 [1.69]	77.77 [3.06]	1/2 -13 UNC	92 [3.62]	56 [2.2]	M12	N/A
		Outlet	38.1 [1.5]	35.71 [1.4]	69.85 [2.75]	1/2 -13 UNC	72.5 [2.85]	45 [1.77]	M12	N/A
	200	Inlet	50.8 [2.0]	42.88 [1.69]	77.77 [3.06]	1/2 -13 UNC	92 [3.62]	56 [2.2]	M12	N/A
		Outlet	38.1 [1.5]	35.71 [1.4]	69.85 [2.75]	1/2 -13 UNC	72.5 [2.85]	45 [1.77]	M12	N/A

Dimensions

TAP4NN - 01FA, 01DA, and 01BA

The drawing shows the TAP4NN standard porting for 01FA, 01DA and 01BA.

mm
[in]

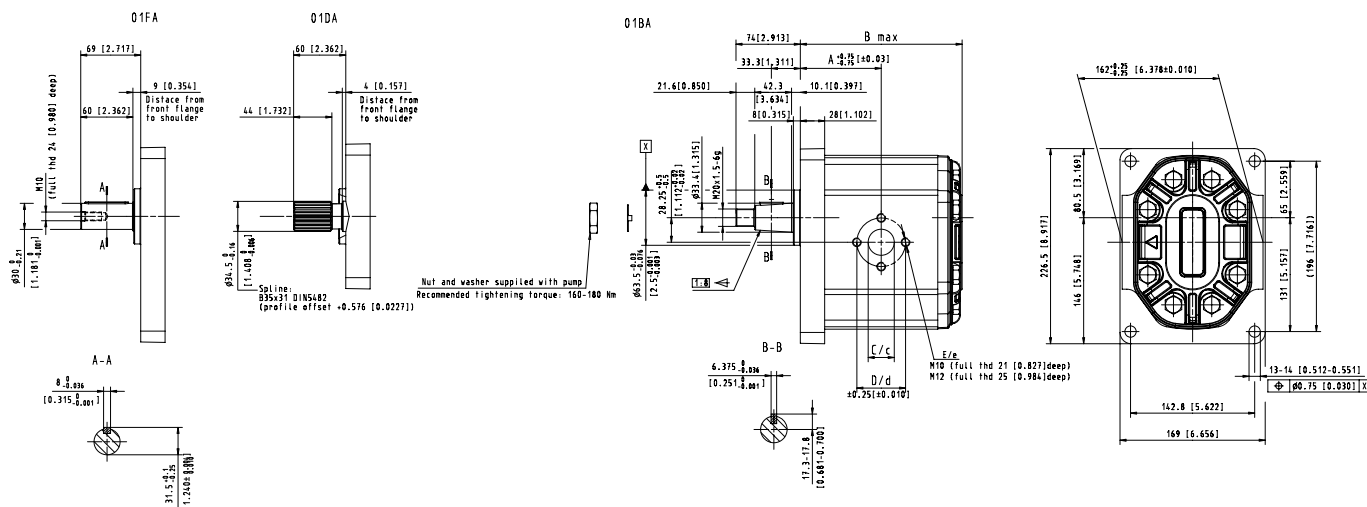

TAP4NN – 01FA, 01DA, 01BA dimensions

Frame size		060	085	106	130	148	180	200
Dimension	A	84 [3.3]	89 [3.5]	93 [3.66]	97.5 [3.84]	101 [3.98]	107 [4.21]	111 [4.37]
	B	168 [6.61]	178 [7.0]	186 [7.32]	195 [7.68]	202 [7.95]	214 [8.42]	222 [8.74]
Inlet	C	36 [1.42]			45 [1.77]		56 [2.2]	
	D	62 [2.44]			72.5 [2.85]		92 [3.62]	
	E	M10			M12		M12	
Outlet	c	30 [1.18]			36 [1.42]		45 [1.77]	
	d	56 [2.2]			62 [2.44]		72.5 [2.85]	
	e	M10			M10		M12	

Model code examples and maximum shaft torque

Flange/drive gear	Model code example	Maximum shaft torque
01DA	TAP4NN/106LN01DAP1CDCBNNNN/NNNNN	850 [7523]
01FA	TAP4NN/148RN01FAP1CHCDNNNN/NNNNN	710 [6284]
01BA	TAP4NN/180RN01BAP1CLCH NNNN/NNNNN	970 [8585]

For further details on ordering, see [Model code](#) on page 7.

Dimensions

TAP4NN - 02RA, and 02GA

This drawing shows the standard porting for 02RA and 02GA.

mm
[in]

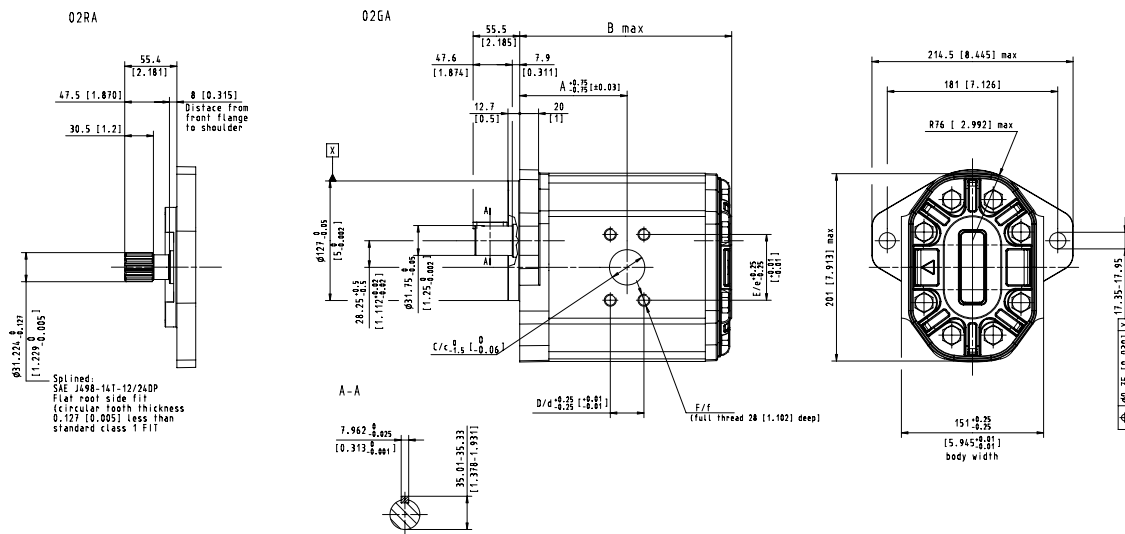

TAP4NN – 02RA, 02GA dimensions

Frame size		060	085	106	130	148	180	200
Dimension	A	87 [3.42]	92 [3.62]	96 [3.78]	100.5 [3.96]	104 [4.1]	110 [4.33]	114 [4.49]
	B	171 [6.73]	181 [7.13]	189 [7.44]	198 [7.79]	205 [8.07]	217 [8.54]	225 [8.86]
Inlet	C	38.1 [1.5]		50.8 [2.0]				
	D	35.71 [1.4]		42.88 [1.69]				
	E	69.85 [2.75]		77.77 [3.06]				
	F	1/2-13UNC		1/2-13UNC				
Outlet	c	31.8 [1.25]		38.1 [1.5]				
	d	30.18 [1.19]		35.71 [1.4]				
	e	58.72 [2.31]		69.85 [2.75]				
	f	7/16-14UNC		1/2-13UNC				

Flange/drive gear configuration	Model code example	Maximum shaft torque N·m [lb·in]
02RA	TAP4NN/060RNO2RAP1A5A4SDNN/NNNNN	800 [7080]
02GA	TAP4NN/130LN02GAP1A6A5SDNN/NNNNN	750 [6638]

For further details on ordering, see [Model code](#) on page 7.

Products we offer:

- DCV directional control valves
- Electric converters
- Electric machines
- Electric motors
- Gear motors
- Gear pumps
- Hydrostatic motors
- Hydrostatic pumps
- Orbital motors
- PLUS+1® controllers
- PLUS+1® displays
- PLUS+1® joysticks and pedals
- PLUS+1® operator interfaces
- PLUS+1® sensors
- PLUS+1® software
- PLUS+1® software services, support and training
- Position controls and sensors
- PVG proportional valves
- Steering components and systems
- Telematics

Danfoss Power Solutions is a global manufacturer and supplier of high-quality hydraulic and electric components. We specialize in providing state-of-the-art technology and solutions that excel in the harsh operating conditions of the mobile off-highway market as well as the marine sector. Building on our extensive applications expertise, we work closely with you to ensure exceptional performance for a broad range of applications. We help you and other customers around the world speed up system development, reduce costs and bring vehicles and vessels to market faster.

Danfoss Power Solutions – your strongest partner in mobile hydraulics and mobile electrification.

Go to www.danfoss.com for further product information.

We offer you expert worldwide support for ensuring the best possible solutions for outstanding performance. And with an extensive network of Global Service Partners, we also provide you with comprehensive global service for all of our components.

Hydro-Gear

www.hydro-gear.com

Daikin-Sauer-Danfoss

www.daikin-sauer-danfoss.com

Local address:

**Danfoss
Power Solutions (US) Company**
2800 East 13th Street
Ames, IA 50010, USA
Phone: +1 515 239 6000

**Danfoss
Power Solutions GmbH & Co. OHG**
Krokamp 35
D-24539 Neumünster, Germany
Phone: +49 4321 871 0

**Danfoss
Power Solutions ApS**
Nordborgvej 81
DK-6430 Nordborg, Denmark
Phone: +45 7488 2222

**Danfoss
Power Solutions Trading
(Shanghai) Co., Ltd.**
Building #22, No. 1000 Jin Hai Rd
Jin Qiao, Pudong New District
Shanghai, China 201206
Phone: +86 21 2080 6201

Danfoss can accept no responsibility for possible errors in catalogues, brochures and other printed material. Danfoss reserves the right to alter its products without notice. This also applies to products already on order provided that such alterations can be made without subsequent changes being necessary in specifications already agreed. All trademarks in this material are property of the respective companies. Danfoss and the Danfoss logotype are trademarks of Danfoss A/S. All rights reserved.