



GENERAL CATALOGUE | 3.1



SKSSWEDEN

GENERAL CATALOGUE | 3.1

Beta Version



This catalogue cancels and replaces any previous edition or revision. UNIMEC S.p.a. declines all responsibility for any compilation mistakes in the catalogue and reserves the right to implement modifications for the sake of construction requirements and of the product's evolution development.

The specifications and information contained in this catalogue are believed to be accurate.

It is nevertheless the UNIMEC products user's responsibility to check the applicability of said components on the specific applications.

The drawings and photos contained in the catalogue are only explanatory.

All rights are reserved, no part or the whole of the above catalogue may be reproduced without permission from the publisher.



SKSSWEDEN

INDEX



Company 4



Trapezoidal Screw Jacks 14



Stainless Steel Trapezoidal Screw Jacks 50



Technopolymer Screw Jacks 58



Accessories 70



Ball Screw Jacks 96



Accessories 108



Bevel Gearboxes 116



Stainless Steel Bevel Gearboxes 152



Accessories 168



Mechanical Speed Modulators 176



Couplings and Transmission Shafts 178



Proprietary Lubricants 180





1981



The Milan hinterland



20.000 m² of production area



3



5



SKSSWEDEN

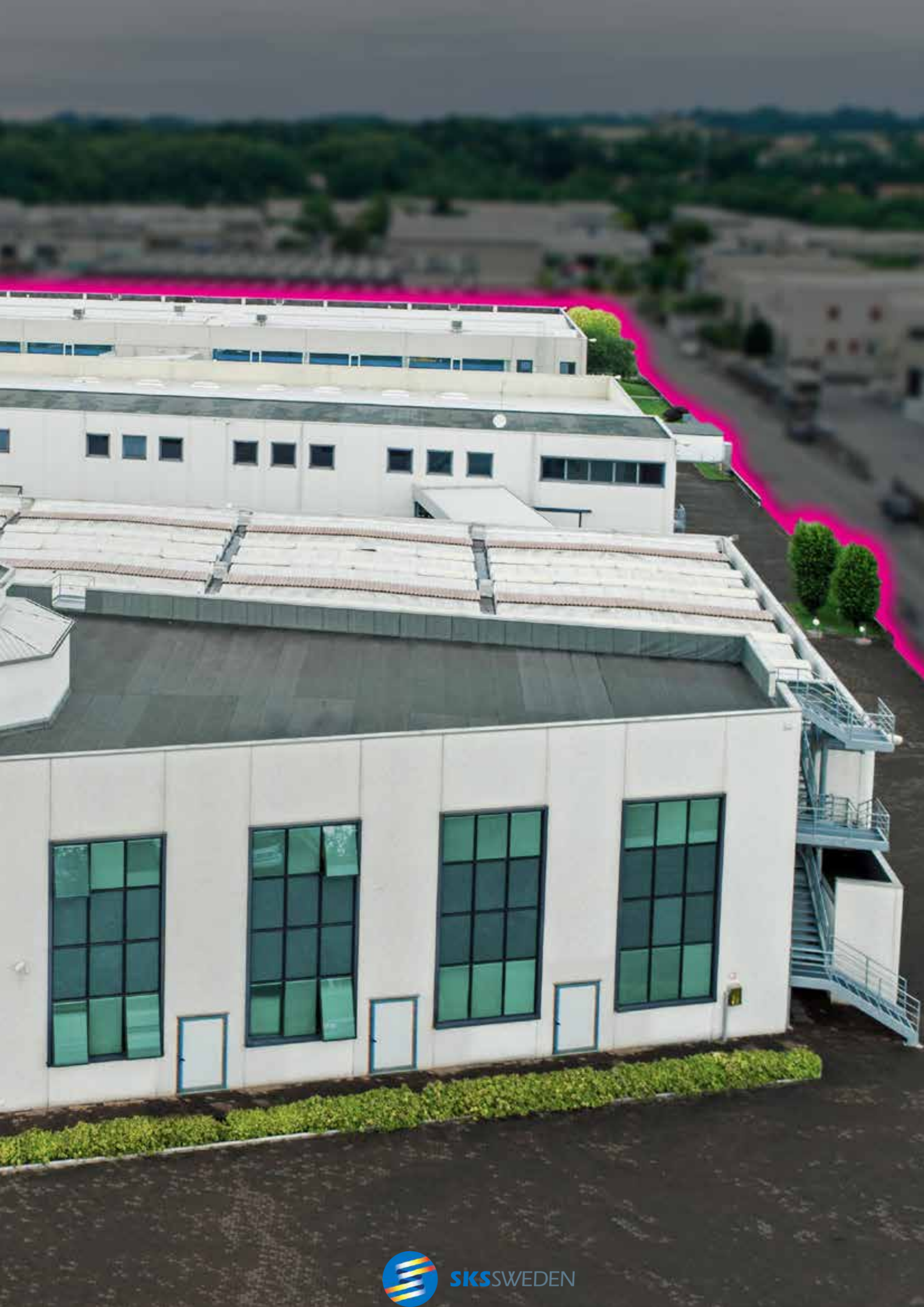

A completely *made in* Unimec production chain



SKSWEDEN

In an era of mass globalization, Unimec took a different path and decided to focus on a completely “**made in Unimec**” production. The design and engineering of our products relies on a team of extremely qualified professionals mastering the latest and most advanced technologies; Solid Forming, FEA, TRIZ Analysis are well-known and vastly used methodologies within our Technical Department: we can proudly claim that any newly designed product contains at least 80% proprietary content manufactured in house, starting with fully certified, traceable and Italy-sourced raw materials.

We firmly believe that owning all of the production technologies used for the manufacturing of each unit from scratch, enables us to grasp all of the technical aspects of our products and allows us to form an in-depth understating of their core characteristics; this also facilitates the design of tailor-made and custom solutions. The entire manufacturing process is performed with the help of the latest generation CNC machines and robotic feeders for unmanned production. A tour of our manufacturing facilities reveals a vast array of multi-axis CNC mills, lathes, gear-cutting machines, broaching machines, temperature-controlled rolling machines, orbital and tangential threading machines for lengths up to 20 feet, precision grinding machines, as well as a fully certified, zero environmental impact, water-based painting line. A state of the art Metrological Analysis Lab completes the manufacturing and quality process and provides vital feedback to our Research & Development Department.



All of the main aspects of our organization are organically connected to one another to create a harmonic business process: a prompt, competent and courteous Customer Service; an efficient and accurate management of software, hardware and data back-up; a constantly stocked inventory, etc. Taken individually, all of these aspects are like single tunes; but masterfully arranged, they transform into a spectacular symphony. The 4th Industrial Revolution, the so called "Industry 4.0", is already a reality within the Unimec organization and represents the connective tissue between the various departments. A sophisticated Configurator Tool helps our customers to effortlessly navigate through the over 80 billion combinations in terms of models, sizes, ratios, materials, configurations and accessories available for all of our products. Orders are automatically generated, entered in the fully automated production pipeline and constantly monitored and updated by a barcode-based system. A live update of the projected lead times ensures that the entire company works like a symphony. But every orchestra is made of musicians and, at Unimec, our people are the pulsing heart of our organization; all of our efforts are geared towards the valorization of each and every employee, the true main characters of each revolution, even those that are about to happen: we are ready.

Unimec is a global group with multiple locations across the world: we have branches in the **United States, Germany, France and Spain**, as well as an additional branch in the **northeast of Italy**. Our international sales organization is integrated by a capillary network of competent distributors located in every corner of the planet, from **Australia to South America, through Asia and Europe**. Responsiveness is one of the main parameters for the evaluation of a company; our goal is to communicate with all of our customers in their native language: each communication from Unimec is released in 5 different languages. Additionally, our network of distributors and representatives are always glad to assist in all other local idioms.

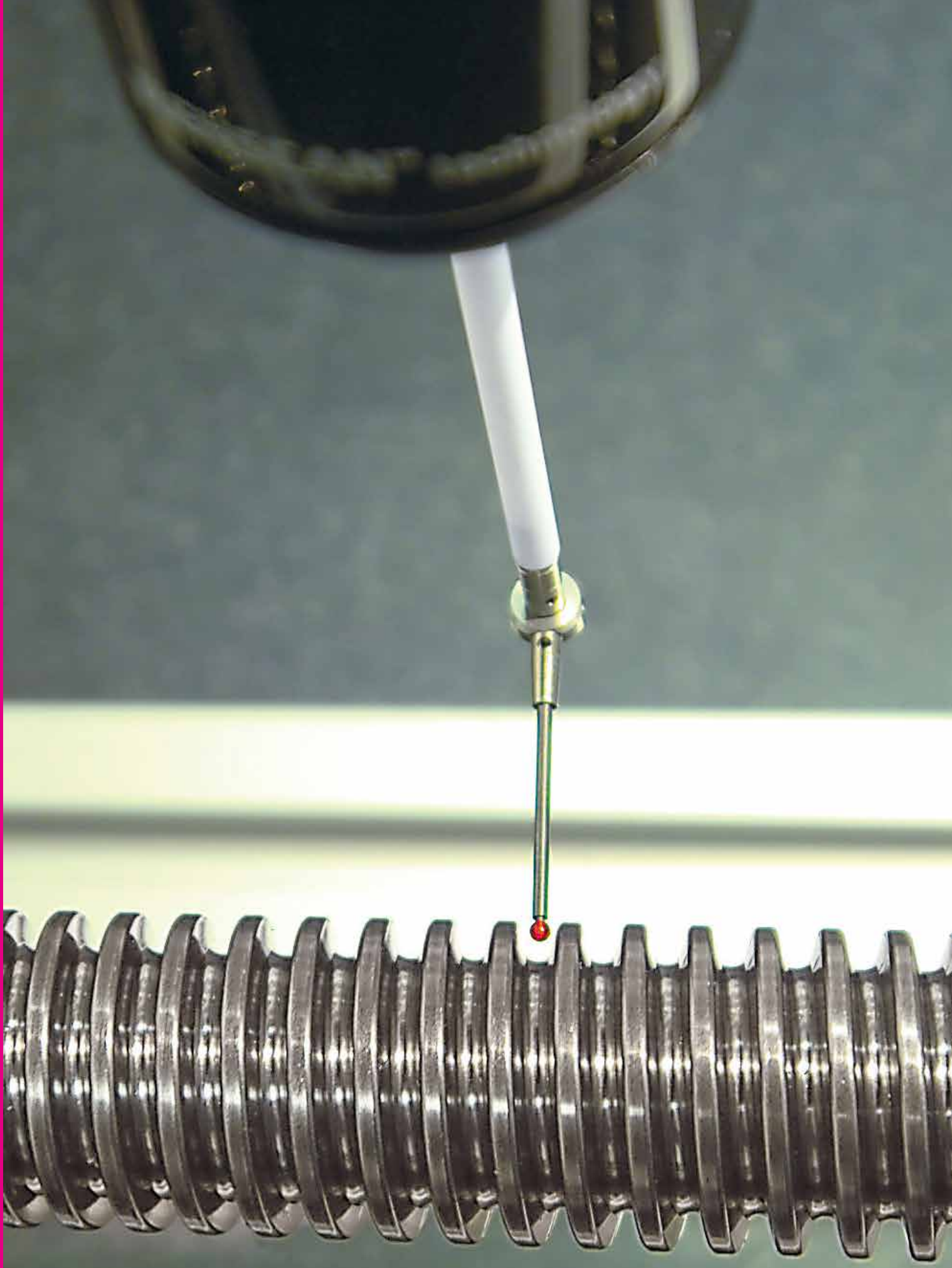

The core values of our organization, explained in detail in the above paragraphs, are perfectly summarized by our tagline: Ars Mechanica. The choice of the Latin language is not just a quirk: Latin is automatically associated with Italy, which connects to our origins, but is also the root of many modern languages, so it is also well suited to our international vocation. Additionally, Latin is also an erudite language, a direct segway to the fine engineering that is at the core of all of our products. Finally, a literal translation of Ars Mechanica reveals various complementary interpretations: “Mechanical Art”, representing both the superior craftsmanship in all of our products and the stark sense of beauty at the root of our unique design. Ars Mechanica can also be associated to the concept of “state of the art”, a virtuous combination of professionalism and work ethics, which are Unimec’s core principles and values.

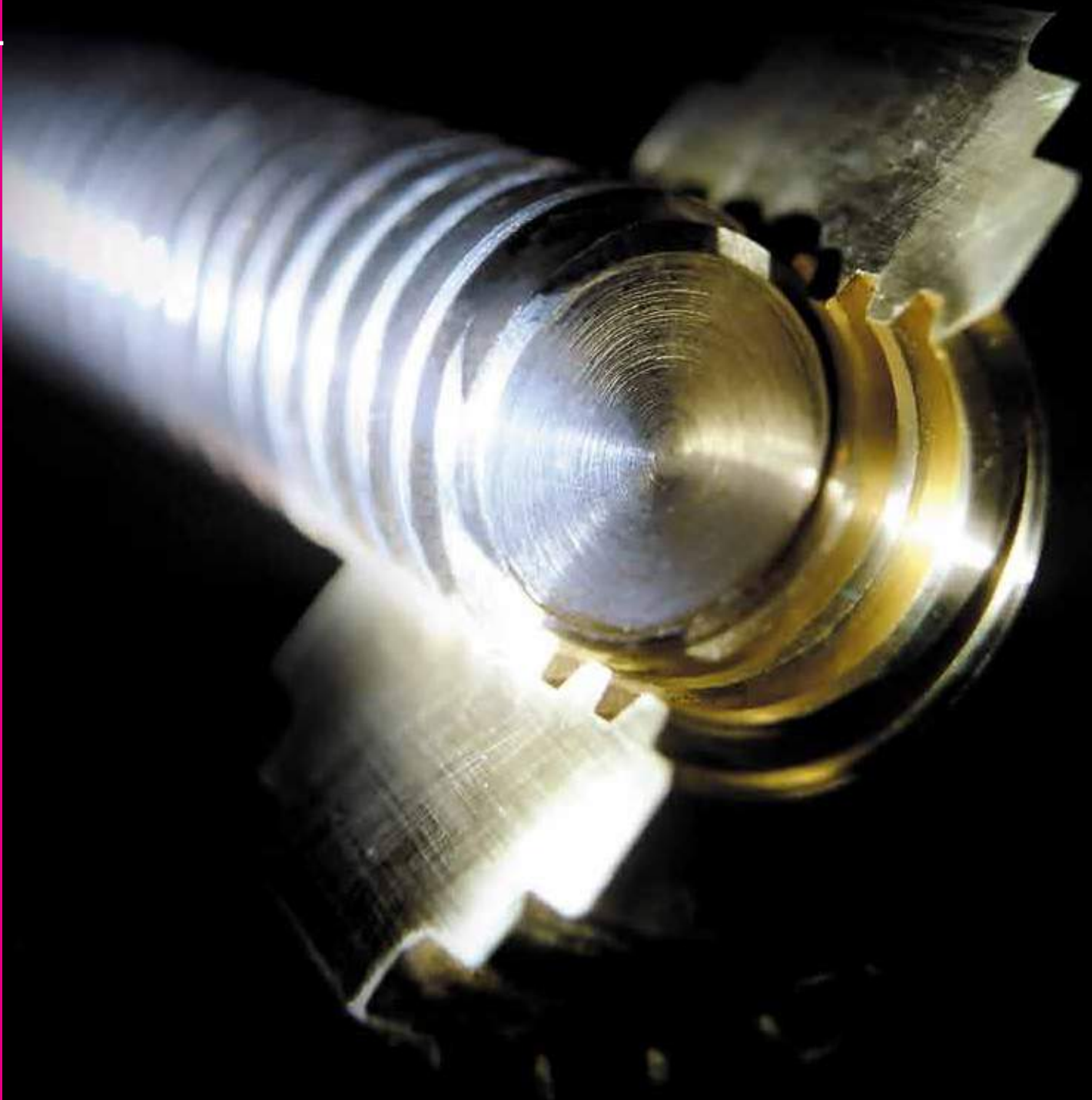

Trapezoidal screw jacks

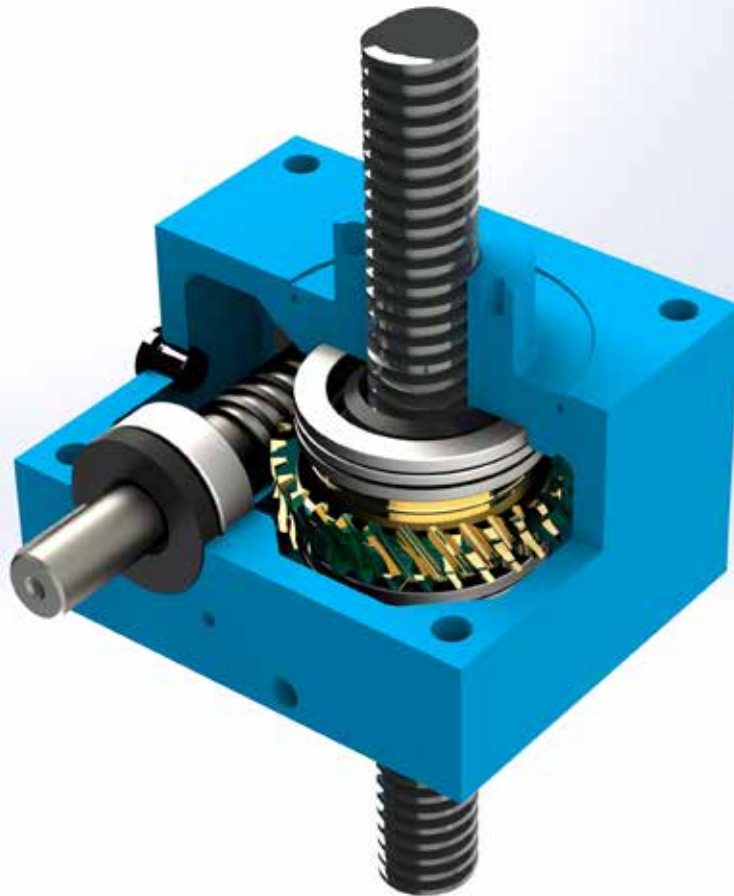

Ease of use and high reliability make UNIMEC trapezoidal screw jacks suitable for a wide variety of uses. They can be employed to lift, pull, move, or align any kind of loads, with a perfect synchronism which can hardly be obtained with other handling methods.

UNIMEC trapezoidal screw jacks are absolutely irreversible, that is, they can support their applied loads without needing any brakes or other locking systems.

The screw jacks can be employed singularly or in groups properly connected with shafts, joints, and/or bevel gearboxes. They can be driven by different motors: electrical, with either alternating or direct current, as well as hydraulic or pneumatic motors. Also they can be driven manually or with any other type of transmission.

In addition to the models shown on the following pages, UNIMEC can produce custom designed screw jacks to meet all the requirements.

UNIMEC trapezoidal screw jacks are redesigned and manufactured using innovative technology so to supply a product which identifies itself with the state of the art in the transmission devices.

The highest quality and a 37 years long experience are able to meet the most demanding and sophisticated requirements.

The outer surfaces are completely machine finished and the parts are assembled with special care, in order to allow the application of supports, flanges, pins, or any other components a project may require. The application of double guides throughout the product line provides a very good running efficiency even under the most strenuous operating conditions.

Special sealing systems enable the inner gears to operate in a bath of lubricant, which guarantees them a long lasting life.

Handling

MOTORIZED OPERATION

Motors can be used for all jacks in the series. As a standard production, for the IEC unified motors, it is possible to connect them directly to screw jacks having a size between 204 and 8010. Special flanges can be made for hydraulic, pneumatic, brushless motors, as well as for direct current motors, permanent magnet motors, stepper motors and other special motors. In the case where it is not possible to motorize a screw jack directly, a connection by means of a bell house and a joint can be foreseen. In special cases it is also possible to motorize size 183 and the sizes over 8010. The power curves determine, in case of unit service factors and for every single screw jack, the input power according to the size, the ratio, the dynamic load and the linear speed.

MANUAL OPERATION

All screw jacks in the series can be manually operated. Obviously, greater loads can be manually handled by applying further reductions to the screw jack or by increasing the radius of the handwheel.

ROTATION DIRECTIONS

The rotation directions and the respective linear movements are showed in the drawings below. In standard conditions UNIMEC supplies screw jacks equipped with right handed worm screw, to which the movements illustrated in drawings 1 and 2 correspond. Upon request it is possible to have a left-handed worm screw, which the movements illustrated in drawings 3 and 4 correspond to. The combinations between threaded spindles and left-handed or right-handed worm screw, lead to the four combinations listed in the table below. We remind, that UNIMEC's standard production does not include motorized left-handed worm screw.

Worm screw	RH	RH	LH	LH
Threaded spindle	RH	LH	RH	LH
Direct motorization on the worm screw	possible	possible	impossible	impossible
Handling	1-2	3-4	3-4	1-2

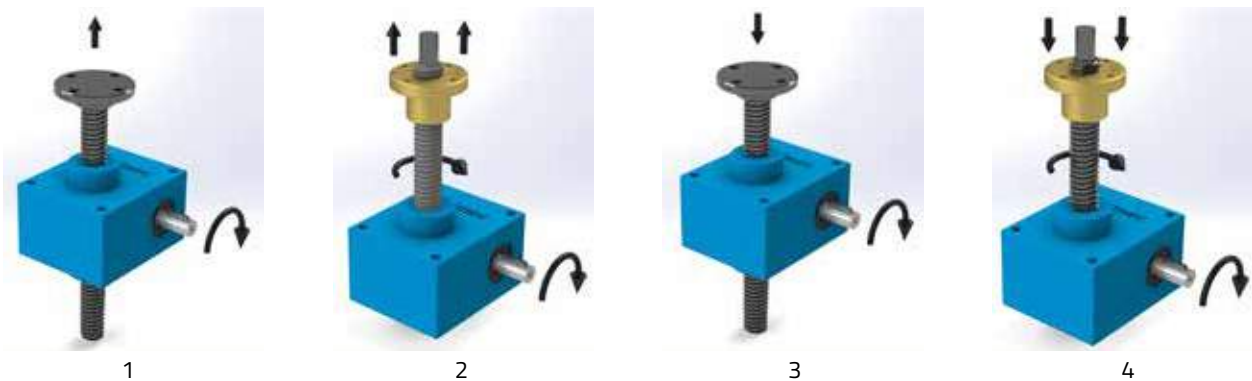

Inner lubrication

The lubrication of the inner transmission devices to the casing is made, in the serial production, using a long lasting grease: TOTAL MARK CA. It is an extreme pressure lubricant based on calcium sulfonate. For size 183, on the contrary, the TOTAL MULTIS MS 2 is used, which is a calcium-soap grease, suited for extreme pressures

as well. In any case a plug is foreseen for all sizes (except for 183) in case of lubricant filling up.

The technical specifications and the application field for the lubricant inside the casing are listed below.

Lubricant	Application field	Operating temperature [°C]*	Technical specifications
UNIMEC MARK CA	Standard	-15 : +130	DIN 51502: OGPON -25 ISO 6743-9: L-XBDIB 0
TOTAL MULTIS MS2	Standard (taglia 183)	-15 : +100	DIN 51502: MPF2K -25 ISO 6743-9: L-XBCEB 2
TOTAL NEVASTANE HT/AW-1	Food industry	-10 : +150	NSF-USDA: H1

* for operating temperatures included between 80°C and 150°C Viton® seals should be used; for temperatures higher than 150°C, and lower than -20°C, it is advisable to contact our Technical office.

The threaded spindle

The end user is responsible for the lubrication of the threaded spindle which must be carried out using an adhesive lubricant, addicted for extreme pressures:

Lubricant	Application field	Operating temperature [°C]*	Technical specifications
UNIMEC MARK CA	Standard	-15 : +130	DIN 51502: OGPON -25 ISO 6743-9: L-XBDIB 0
TOTAL NEVASTANE EP 1000	Food industry	0 : +130	NSF-USDA: H1

* for operating temperatures included between 80°C and 150°C Viton® seals should be used;
for temperatures higher than 150°C, and lower than -20°C, it is advisable to contact our Technical office.

Lubricating the threaded spindle is an important and determining factor in the proper functioning of the screw jack. It must be carried out at regular intervals that can assure a constant coat of clean lubricant between the contact parts. Insufficient lubrication, the use of an oil without extreme pressure additives or an improper lubrication can lead to abnormal overheating and consequent

wear phenomena, which naturally reduce the operating life of the screw jacks. In case the screw jacks are not visible or the threaded spindles are covered by protections, it is necessary to periodically verify the lubrication conditions. For heavier duties than those showed in the relative graphs it is recommended to contact our Technical office.

Backlash

BACKLASH ON THE WORM SCREW

The worm screw – worm wheel coupling has a small degree backlash. Due to the reduction ratio and the transformation from the rotation movement to the translation movement, this backlash becomes an error of less than 0,05 mm in the linear positioning of the threaded spindle.

LATERAL BACKLASH IN TP MODELS

The thread spindle and worm wheel coupling presents a natural and necessary lateral backlash indicated by A in the drawing below. The use of a double serial guide allows to minimize the entity of said backlashes, while keeping the spindle and support nut axes aligned. The angular backlash on the coupling is translated on the spindle end fitting into a linear measure whose value depends on the size of the screw jack and grows according to the length of the spindle itself. Traction loads tend to reduce this backlash, while compression loads induce the opposite effect.

LATERAL BACKLASH IN TPR MODELS

In TPR models the spindle and the worm wheel are locked by means of a double pins. UNIMEC carries out this operation by means of a suitable machine which keeps the axes of the two components coincident during the two drillings and the consequent pins insertions. Hence, the threaded spindle rotates minimizing the oscillations due to concentricity errors. For a proper operation it is necessary for the user to provide solutions able to keep the spindle and the lead nut aligned. The guides can be external or directly implicate the structure of the lead nut, as can be seen in the following drawings.

AXIAL BACKLASH

In B the axial backlash between the threaded spindle and its support nut (either a worm wheel or a lead nut) is caused by the natural and necessary tolerance characterizing this kind of couplings. For construction purposes it is only important in the case where the load changes its direction of application. For applications where there can be reciprocating traction and compression loads, and therefore a need to compensate the axial backlash, it is possible to apply a backlash reduction system. The axial backlash reduction must not be forced in any case, in order to avoid that the screw and the support nut get blocked.

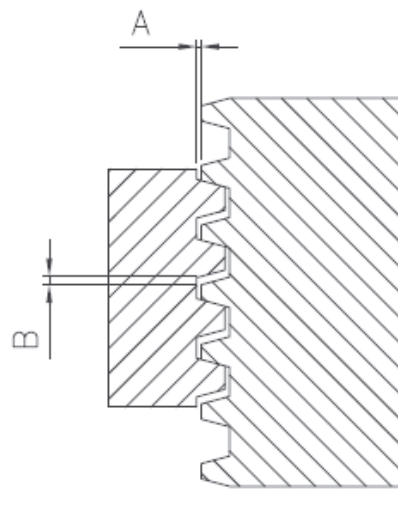

Installation and maintenance

INSTALLATION

The screw jack must be installed in a manner that does not create lateral loads on the threaded spindle. Great care must be taken to ensure that the threaded spindle is orthogonal to the mounting plane, and that the load and threaded spindle are on the same axis. Employing multiple screw jacks to handle the same load requires further verifications: it is critical that the load support points, (the end fittings for TP models and the lead nuts for TPR models), are perfectly aligned in order that the load can be uniformly distributed; otherwise the misaligned screw jacks would act as brake or counter-load. Whenever several jacks have to be connected by means of transmission shafts, it is recommended that they be perfectly aligned in order to avoid overloading of the worm screws. It is advisable to use joints capable of absorbing alignment errors but having, at the same time, a rigid torsion necessary to keep the synchronization of the transmission. The assembly or disassembly of the joints or pulleys of worm screw must be carried out by means of tie rods or extractors, using, if necessary, the threaded hole on top of the worm screw; striking or hammering could damage the inner bearings. For heat-shrinking joints or pulleys, we recommend a temperature between 80-100 °C. Installations environments with dust, water, vapors, etc. require precautions to protect the threaded spindle. This can be done by using elastic or rigid protections. The above protections are also used in order to avoid any accidental human contact with the moving devices. For civil applications it is always advisable to use the safety components.

PREPARING FOR SERVICE

All UNIMEC's screw jacks are supplied filled with long lasting lubricant which ensures a perfect lubrication of the worm gear/worm wheel group and all the inner parts. All screw jacks, except for the size 183, are equipped with a lubricant plug for filling-up the lubricant as necessary. As clearly explained on relative paragraph, lubrication of the threaded spindle is a user's responsibility and must be carried out periodically depending on the duty conditions and the operating environment. Special systems are available for holding the screw jacks in any position without creating leakage problems. The application of some accessories can limit these assembly possibilities: the various solutions to be adopted will be explained in the relevant paragraphs.

START-UP

All screw jacks undergo a careful quality examination before being delivered to the client, and are dynamically tested load-free. When starting-up a machine where screw jacks are installed, it is critical to check for the lubrication of the threaded spindles and for the absence of foreign material. During the calibration phase of the electrical end-of-stroke systems, the inertia of the moving masses should be taken into account, which for vertical loads will be lower in ascent and greater in descent. It is advisable to start-up the machine with the minimum possible load and to make sure all components are working properly, before assuming regular operation. Especially at start-up, it is critical to follow the instructions given in the manual: continuous or hazardous testing maneuvers could lead to an abnormal overheating of the screw jacks and cause irreparable damages. One single temperature peak is enough to cause premature wear or breakdown of the screw jack.

ROUTINE MAINTENANCE

Screw jacks must be periodically inspected, depending on the level of use and working environment. It is advisable to check for lubricant leakages from the casing, and, if this occurs, it is necessary to find and eliminate the cause and fill the lubricant up the correct level. The lubrication conditions of the threaded spindle must be periodically inspected (and restored if necessary) as well as the presence of any foreign material. The safety components must be inspected according to the applicable norms.

STORAGE

Screw jacks must be protected from deposits of dust and foreign matter during storage. Particular attention must be paid to saline or corrosive atmospheres. We also recommend to:

- 1 - Periodically rotate the input shaft to ensure proper lubrication of the inner parts and avoid that the seals dry up, therefore causing lubricant leakages.
- 2 - Lubricate and protect the threaded spindle, the worm screw and the non varnished components.
- 3 - Support the threaded spindle in case of horizontal storage.

WARRANTY

Warranty is valid given when the instructions contained in our manual are carefully followed.



Loads

Choosing the right screw jack, and hence also its proper functioning, mostly depends on the identification of the real load acting on the screw jack. Loads can be divided in two main groups: static loads and dynamic loads; these groups are further made-up of: traction loads, compression loads, lateral loads, radial loads, eccentric loads, loads from shocks, loads from vibrations.

STATIC LOADS

A static load is the force that will be applied to the screw jack transmission devices while they are not in motion.

DYNAMIC LOADS

A dynamic load is the force that will be applied to the screw jack transmission devices while they are in motion.

TRACTION LOADS

A traction load is the force applied to the threaded spindle axis with an opposite direction to the casing.

COMPRESSION LOADS

A compression load is a force applied to the threaded spindle axis with the same direction as the casing.

LATERAL LOADS

A lateral load is a force applied perpendicular to the threaded spindle axis.

ECCENTRIC LOADS

An eccentric load is a force whose centre of application does not belong to the threaded spindle axis, even having the same direction.

LOADS FROM SHOCKS

A load from shocks is a load where the impulse forces generated by an impact are not quantifiable.

LOADS FROM VIBRATIONS

A load from vibrations is applied when a shock load increases the impulse frequency.

Depending on the type of load some solution must be applied during the design phase:

STATIC TRACTION LOAD

The maximum applicable load for all models and sizes is shown in the specification tables. Shocks and/or lateral loads limit its applications.

DYNAMIC TRACTION LOAD

The maximum dynamic traction load which can be applied to a screw jack does not only depend on its size: it could be limited by the ambient temperature, service factors and possible lateral loads and/or shocks. It is thus necessary to check all those parameters.

STATIC COMPRESSION LOAD

The maximum load which can be applied is determined by the length of the threaded spindle as well as by the constraints it undergoes. The limit applicable load can be obtained on the basis of the Euler diagrams. Its application could be limited by possible shocks and/or lateral loads.

DYNAMIC COMPRESSION LOAD

The maximum compression load which can be applied is determined by many factors: the length of the threaded spindle, the ambient temperature, service factors and possible lateral loads and/or shocks. In addition to all the verifications already foreseen in the case of a traction load, further verifications are necessary relative to the Euler diagrams.

STATIC LATERAL LOAD

This kind of load induces a lateral shifting of the threaded spindle causing a damaging bending which limits the ability of the screw jack. Suitable graphs show the maximum lateral load values according to the length and size of the threaded spindle. For any further and more detailed verifications our technical office is at your disposal.

DYNAMIC LATERAL LOAD

A lateral load in dynamic applications is not allowed. In case of essential use of screw jacks with lateral load is for machine requirements, it will be necessary to contact our technical office.

ECCENTRIC STATIC LOAD

An eccentric load in static applications induces the same problems as the lateral loads. For this reason the above considerations are also applicable to this kind of load.

DYNAMIC ECCENTRIC LOAD

In case of handling an eccentric load, in order to avoid problems due to lateral load, it is necessary to create a suitably guided and sized mechanical structure, in order to absorb all the lateral components of the load. The guide must be realized very carefully: too narrow backlashes could cause seizure and stick-slips, while too rough backlashes would make useless the construction of the guide itself.

STATIC LOAD FROM VIBRATIONS OR SHOCKS

A load from vibrations or from shock, if not very heavy, could be the only reasons for the reversibility of the transmission moved by the screw jack. In that case it is advisable to contact our technical office in order to verify the screw jack applicability.

DYNAMIC LOAD FROM VIBRATIONS OR SHOCKS

A dynamic load from vibrations or from shock can be damaging for the screw jack: stick-slip phenomena and consequent local overloads can enormously increase the wear conditions. It is necessary to minimize the shocks entity and the vibrations width

TP Model

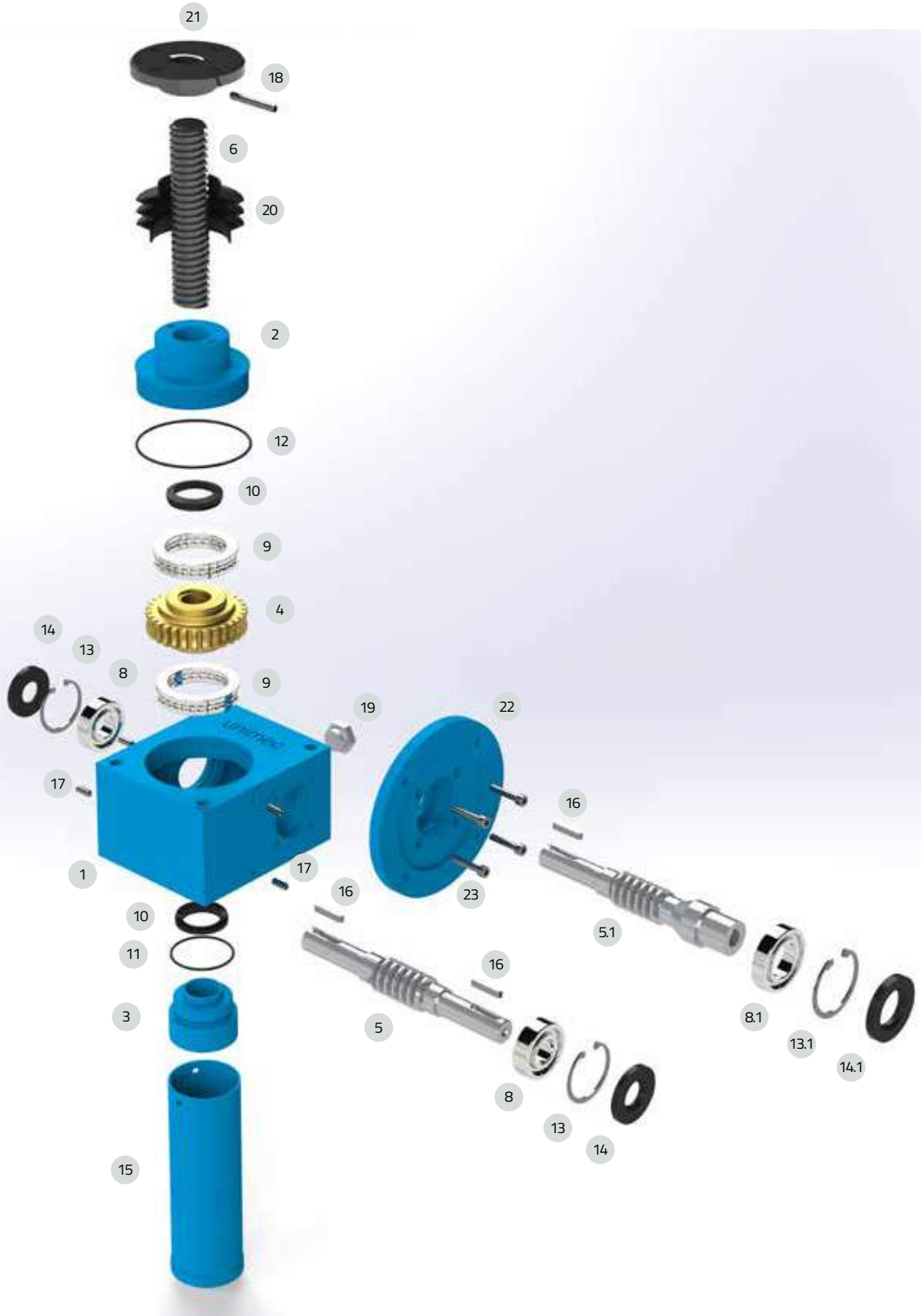

1 Casing	8 Worm screw bearing	13.1 Snap ring for motoring	19 Plug
2 Cover	8.1 Motor worm screw bearing	14 Seal	20 Elastic protection
3 Guide bushing	9 Worm wheel bearings	14.1 Seal for motoring	21 End fitting
4 Worm wheel	10 Seal	15 Rigid protection	22 Motor flange
5 Worm screw	11 Seal	16 Key	23 Screws
5.1 Motor worm screw right-handed	12 Seal	17 Dowel	
6 Threaded spindle	13 Snap ring	18 End fitting elastic fastening pin	

TPR Model

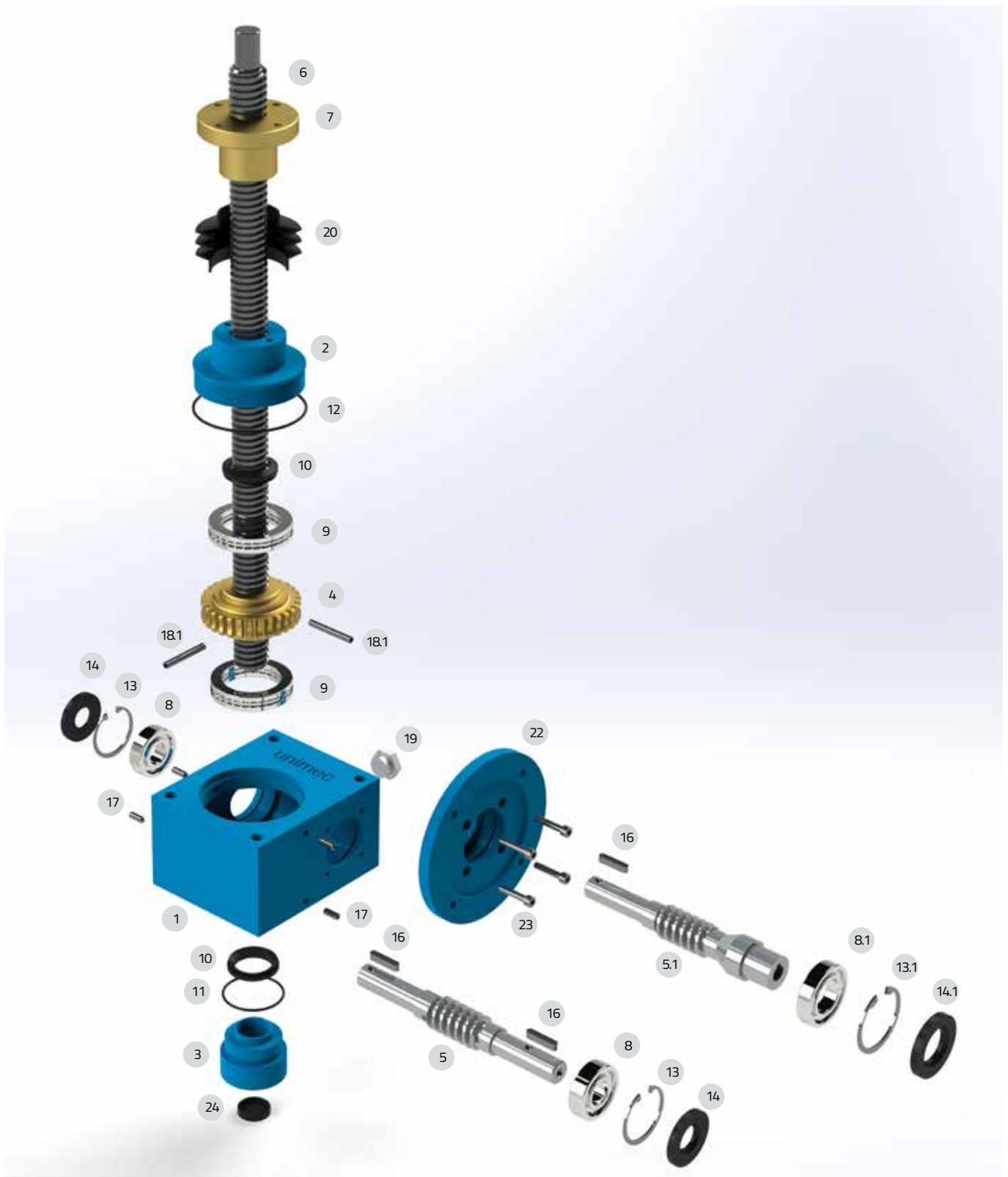

1 Casing	7 Lead nut	13 Snap ring	19 Plug
2 Cover	8 Worm screw bearing	13.1 Snap ring for motoring	20 Elastic protection
3 Guide bushing	8.1 Motor worm screw bearing	14 Seal	22 Motor flange
4 Worm wheel	9 Worm wheel bearing	14.1 Seal for motoring	23 Screws
5 Worm screw	10 Seal	16 Key	24 Seal
5.1 Motor worm screw right handed	11 Seal	17 Dowel	
6 Threaded spindle	12 Seal	18.1 Worm wheel elastic fastening pin	

Size 183 - 0,5 ton - 5 kN



TP Model



TP Model

Materials

	Material	Norms	Specs	Indications
Worm	16NiCr4	EN 10084:2008	Casehardening alloy steel	Casehardened and ground on teeth and holds
Worm wheel	CuAl10Fe2-GM	EN 1982:2008	Aluminium bronze	Chill molded
Nut	CuAl10Fe2-GM	EN 1982:2008	Aluminium bronze	Chill molded
Spindle	C45	EN 10083-2:2006	Carbon steel	Tr 18x3 (ISO 2901:2016) - Rolled or machined
Carter	AlSi12	EN 1706:2010	Aluminium alloy	Completely machined on 6 faces
Lubricant	Total Multis MS2		Calcium based grease	60 g

General features

Operating Temperature	-10 °C / 80 °C
Static Load (traction or compression)	10 kN
Dynamic Load (traction or compression)	5 kN
Max input speed	1800 rpm
Main Gearbox Weight	1,8 kg
Trapezoidal Screw Weight	1,6 kg/m
Anti-Rotation Torque with Max Load	7 Nm
Max admissible lateral loads	0 N
Center-to-center distance	30 mm
Max radial Load on worm Screw	100 N
Standard Working Conditions	25 °C - service 10%

Euler's law (safety factor =2; dynamic compression load)

Limit Load 1 (red) - 2 (blue) - 3 (green)

C = Load [kN]

L = Overall trapezoidal screw length [mm]

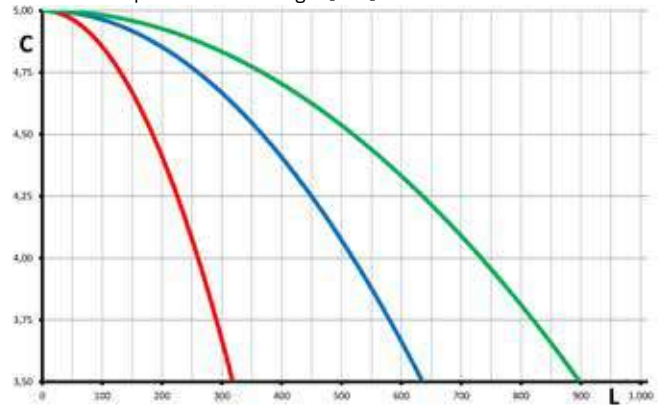

Specific features

	Nominal Ratios	
	1/5	1/20
Real ratio	1/5	1/20
Translation per worm revolution	0,6 mm	0,15 mm
Efficiency	29 %	24 %
Start-up efficiency	20 %	17 %
Maximum linear speed	1080	270
Torque at maximum load	1,7 Nm	0,6 Nm
Worm screw maximum torque	23 Nm	23 Nm
Loadless torque	0,1 Nm	0,08 Nm

Power curves

The magenta zone indicates a potential heating risk. Working cycles must be carefully analyzed.

VR = Worm rotational speed [rpm]

VL = Spindle translation speed [mm/min]

P = Requested input power [kW]

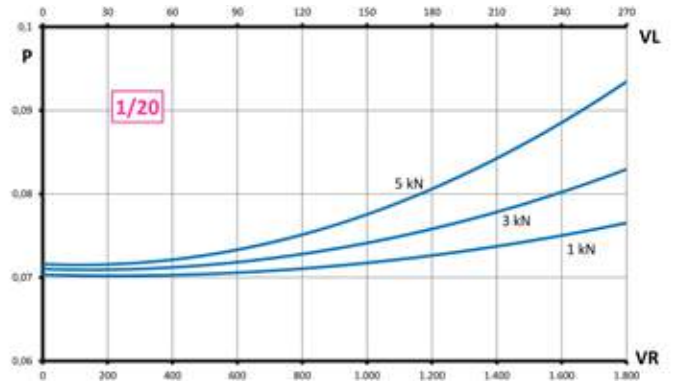
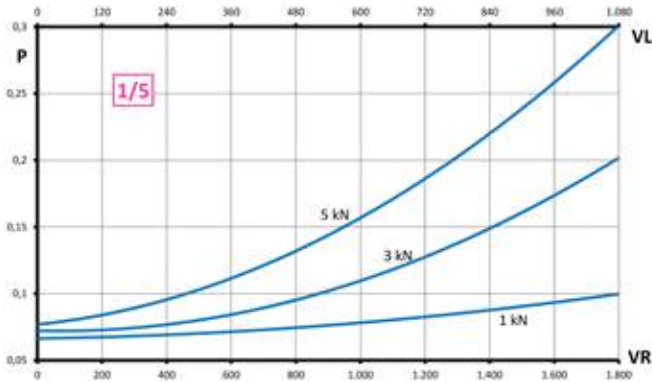

Construction Forms



Form B



Form D



Form S



Form B



Form D



Form S

Size 204 - 1 ton - 10 kN



TP Model

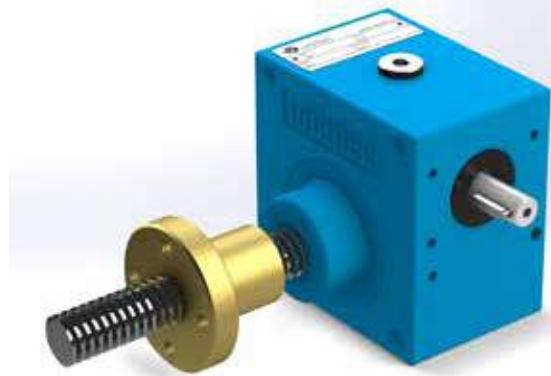

TPR Model

Materials

	Material	Norms	Specs	Indications
Worm	16NiCr4	EN 10084:2008	Casehardening alloy steel	Casehardened and ground on teeth and holds
Worm wheel	CuAl10Fe2-GM	EN 1982:2008	Aluminium bronze	Chill molded
Nut	CuAl10Fe2-GM	EN 1982:2008	Aluminium bronze	Chill molded
Spindle	C45	EN 10083-2:2006	Carbon steel	Tr 20x4 (ISO 2901:2016) - Rolled or machined
Carter	GJL 250	EN 1561:2011	Grey cast iron	Completely machined on 6 faces
Lubricant	Unimec Mark CA		Calcium based grease	0,1 kg

General features

Operating Temperature	-10 °C / 80 °C
Static Load (traction or compression)	20 kN
Dynamic Load (traction or compression)	10 kN
Max input speed	1800 rpm
Main Gearbox Weight	6 kg
Trapezoidal Screw Weight	2,22 kg/m
Anti-Rotation Torque with Max Load	17 Nm
Max admissible lateral loads	0 N
Center-to-center distance	30 mm
Max radial Load on worm Screw	220 N
Standard Working Conditions	25 °C - service 10%

Euler's law (safety factor =2; dynamic compression load)
 Limit Load 1 (red) - 2 (blue) - 3 (green)
 C = Load [kN]
 L = Overall trapezoidal screw length [mm]

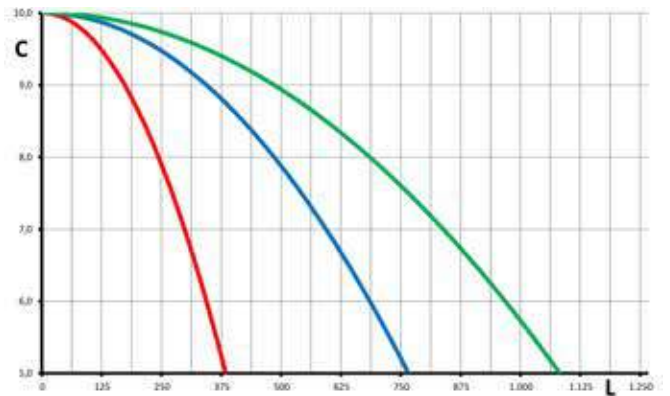

Specific features

	Nominal Ratios		
	1/5	1/10	1/30
Real ratio	1/4,75	1/10,5	1/30
Translation per worm revolution	0,842 mm	0,38 mm	0,13 mm
Efficiency	31 %	28 %	20 %
Start-up efficiency	22 %	19 %	14 %
Maximum linear speed	1440	720	240
Torque at maximum load	4,2 Nm	2,3 Nm	1,1 Nm
Worm screw maximum torque	54 Nm	54 Nm	42 Nm
Loadless torque	0,25 Nm	0,2 Nm	0,15 Nm

Power curves

The magenta zone indicates a potential heating risk. Working cycles must be carefully analyzed.



VR = Worm rotational speed [rpm]

VL = Spindle translation speed [mm/min]

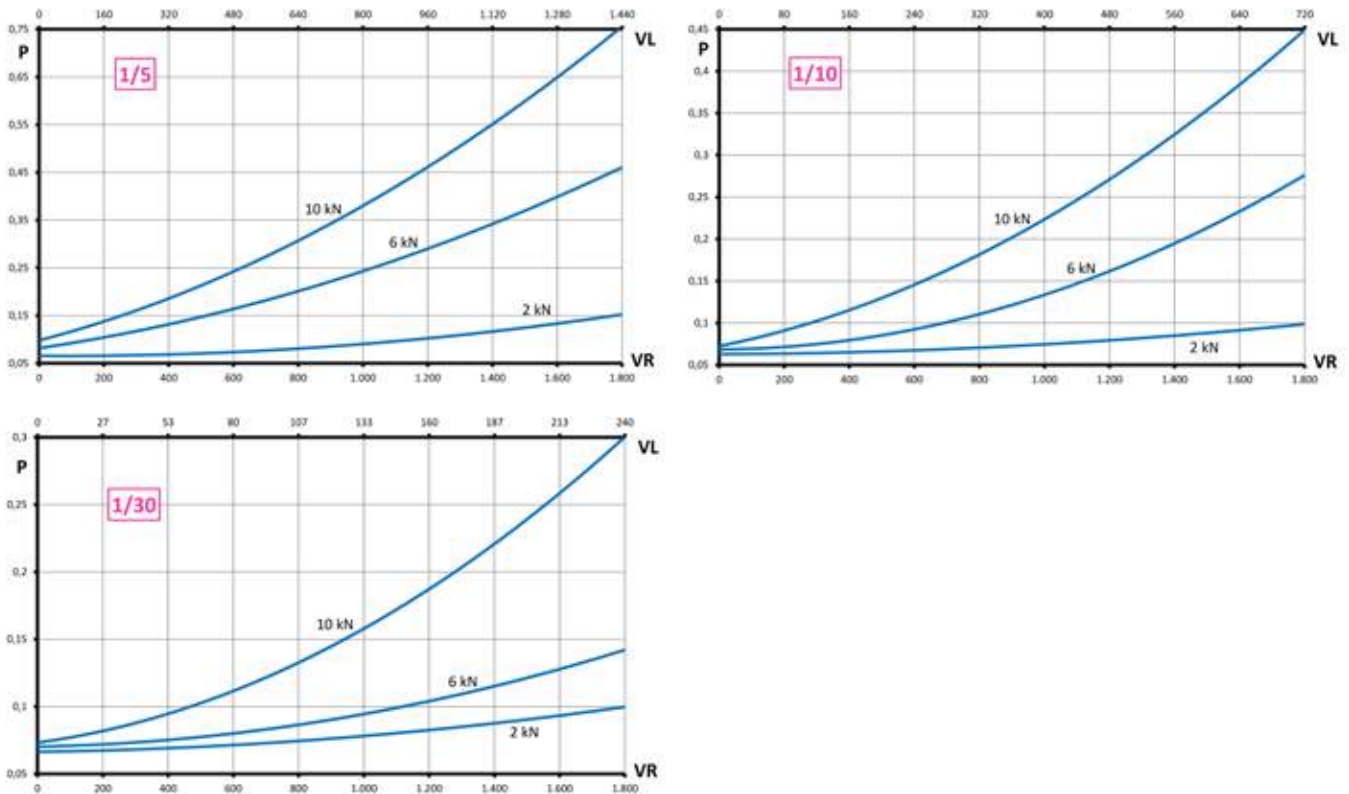
P = Requested input power [kW]



Motor Models

	IEC	Worm screw bore diameter	Centering diameter	Nominal power (4 poles motor)
	IEC 63 B5	11 mm	95 mm	0,25 kW
	IEC 71 B5 / 71 B14	14 mm	110 mm / 70 mm	0,55 kW
	IEC 80 B5 / 80 B14	19 mm	130 mm / 80 mm	1,1 kW

Construction Forms



Size 306 - 2,5 ton - 25 kN



TP Model



TPR Model

Materials

	Material	Norms	Specs	Indications
Worm	16NiCr4	EN 10084:2008	Casehardening alloy steel	Casehardened and ground on teeth and holds
Worm wheel	CuAl10Fe2-GM	EN 1982:2008	Aluminium bronze	Chill molded
Nut	CuAl10Fe2-GM	EN 1982:2008	Aluminium bronze	Chill molded
Spindle	C45	EN 10083-2:2006	Carbon steel	Tr 30x6 (ISO 2901:2016) - Rolled or machined
Carter	GJL 250	EN 1561:2011	Grey cast iron	Completely machined on 6 faces
Lubricant	Unimec Mark CA		Calcium based grease	0,3 kg

General features

Operating Temperature	-10 °C / 80 °C
Static Load (traction or compression)	40 kN
Dynamic Load (traction or compression)	25 kN
Max input speed	1800 rpm
Main Gearbox Weight	10 kg
Trapezoidal Screw Weight	5 kg/m
Anti-Rotation Torque with Max Load	63 Nm
Max admissible lateral loads	0 N
Center-to-center distance	50 mm
Max radial Load on worm Screw	450 N
Standard Working Conditions	25 °C - service 10%

Euler's law (safety factor =2; dynamic compression load)
 Limit Load 1 (red) - 2 (blue) - 3 (green)
 C = Load [kN]
 L = Overall trapezoidal screw length [mm]

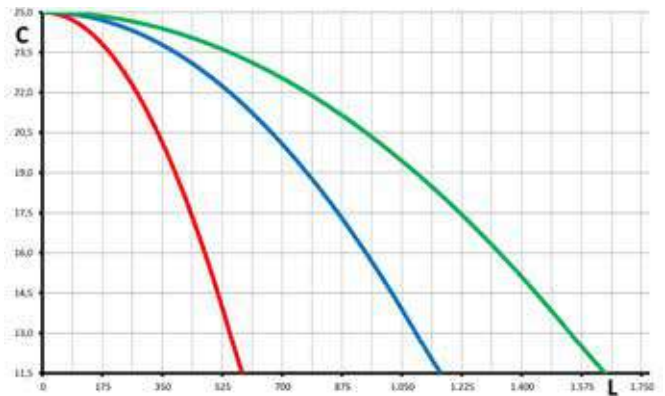

Specific features

	Nominal Ratios		
	1/5	1/10	1/30
Real ratio	1/4,75	1/9,67	1/30
Translation per worm revolution	1,26 mm	0,62 mm	0,2 mm
Efficiency	30 %	26 %	18 %
Start-up efficiency	21 %	18 %	13 %
Maximum linear speed	2160	1080	360
Torque at maximum load	16 Nm	9,3 Nm	4,4 Nm
Worm screw maximum torque	69 Nm	154 Nm	183 Nm
Loadless torque	0,4 Nm	0,3 Nm	0,25 Nm

Power curves

The magenta zone indicates a potential heating risk. Working cycles must be carefully analyzed.



VR = Worm rotational speed [rpm]

VL = Spindle translation speed [mm/min]

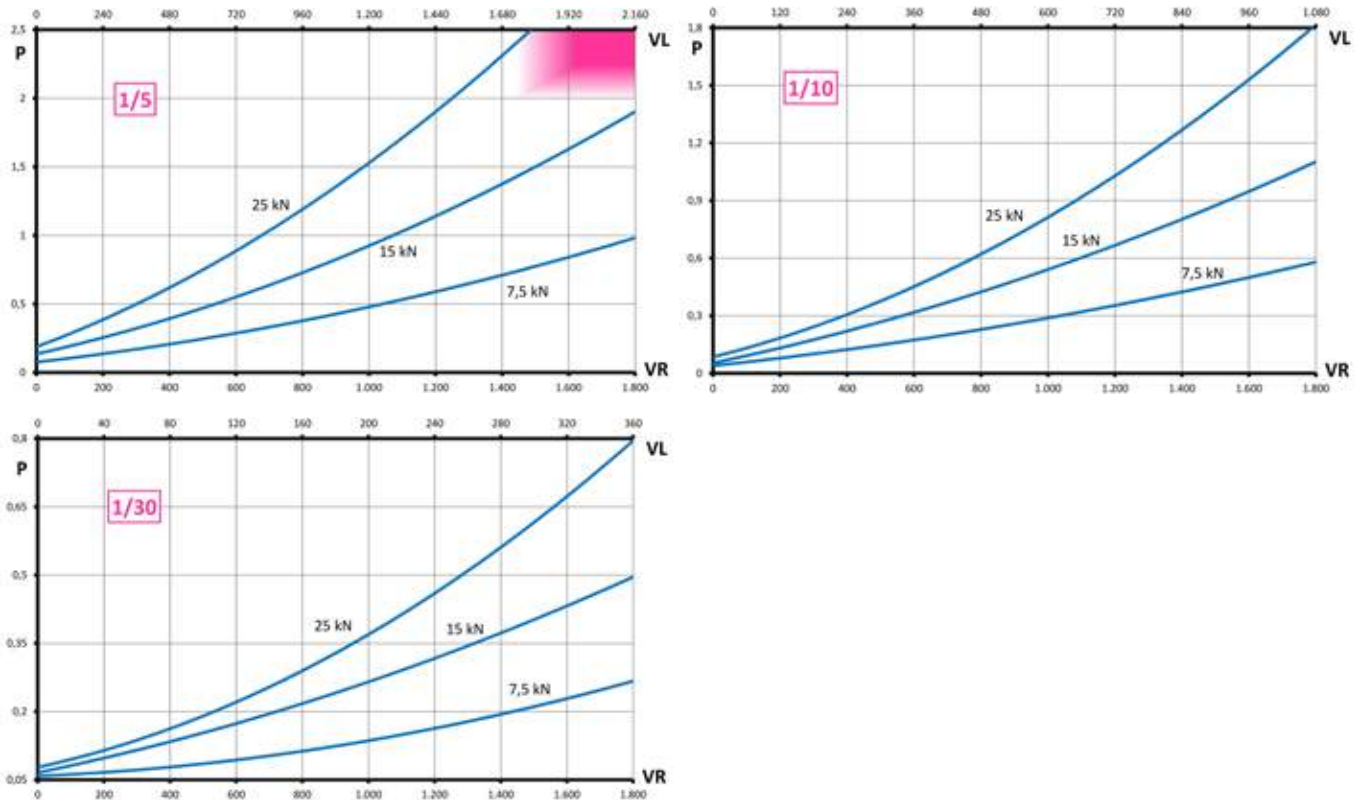
P = Requested input power [kW]



Motor Models

	IEC	Worm screw bore diameter	Centering diameter	Nominal power (4 poles motor)
	IEC 71 B5	11 mm	110 mm	0,55 kW
	IEC 80 B5 / B14	19 mm	130 mm / 80 mm	1,1 kW
	IEC 90 B5 / B14	24 mm	130 mm / 95 mm	1,9 kW
	IEC 100-112 B5 / B14	28 mm	180 mm / 110 mm	5 kW

Construction Forms



Size 407 - 5 ton - 50 kN

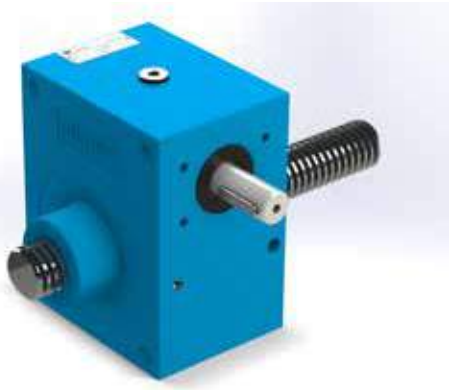

TP Model

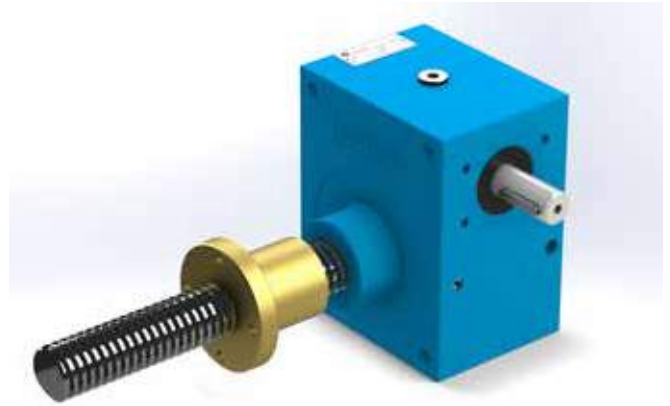

TPR Model

Materials

	Material	Norms	Specs	Indications
Worm	16NiCr4	EN 10084:2008	Casehardening alloy steel	Casehardened and ground on teeth and holds
Worm wheel	CuAl10Fe2-GM	EN 1982:2008	Aluminium bronze	Chill molded
Nut	CuAl10Fe2-GM	EN 1982:2008	Aluminium bronze	Chill molded
Spindle	C45	EN 10083-2:2006	Carbon steel	Tr 40x7 (ISO 2901:2016) - Rolled or machined
Carter	GJL 250	EN 1561:2011	Grey cast iron	Completely machined on 6 faces
Lubricant	Unimec Mark CA		Calcium based grease	0,6 kg

General features

Operating Temperature	-10 °C / 80 °C
Static Load (traction or compression)	80 kN
Dynamic Load (traction or compression)	50 kN
Max input speed	1800 rpm
Main Gearbox Weight	18 kg
Trapezoidal Screw Weight	9 kg/m
Anti-Rotation Torque with Max Load	165 Nm
Max admissible lateral loads	300 N
Center-to-center distance	70 mm
Max radial Load on worm Screw	600 N
Standard Working Conditions	25 °C - service 10%

Euler's law (safety factor =2; dynamic compression load)

Limit Load 1 (red) - 2 (blue) - 3 (green)

C = Load [kN]

L = Overall trapezoidal screw length [mm]

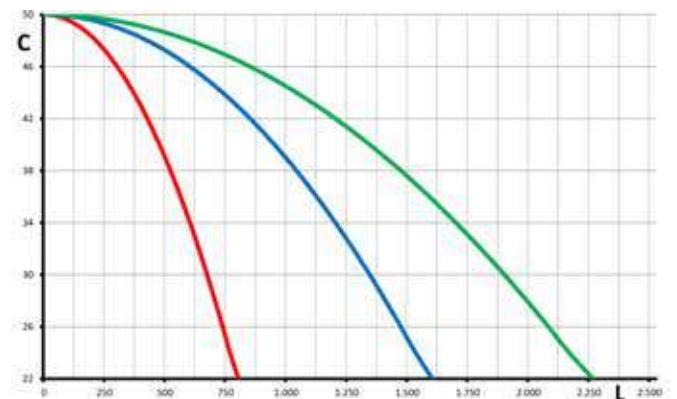

Specific features

	Nominal Ratios		
	1/5	1/10	1/30
Real ratio	1/5	1/10	1/30
Translation per worm revolution	1,4 mm	0,7 mm	0,23 mm
Efficiency	28 %	25 %	18 %
Start-up efficiency	20 %	18 %	13 %
Maximum linear speed	2520	1260	420
Torque at maximum load	40 Nm	23 Nm	11 Nm
Worm screw maximum torque	490 Nm	128 Nm	154 Nm
Loadless torque	0,65 Nm	0,45 Nm	0,35 Nm

Power curves

The magenta zone indicates a potential heating risk. Working cycles must be carefully analyzed.



VR = Worm rotational speed [rpm]

VL = Spindle translation speed [mm/min]

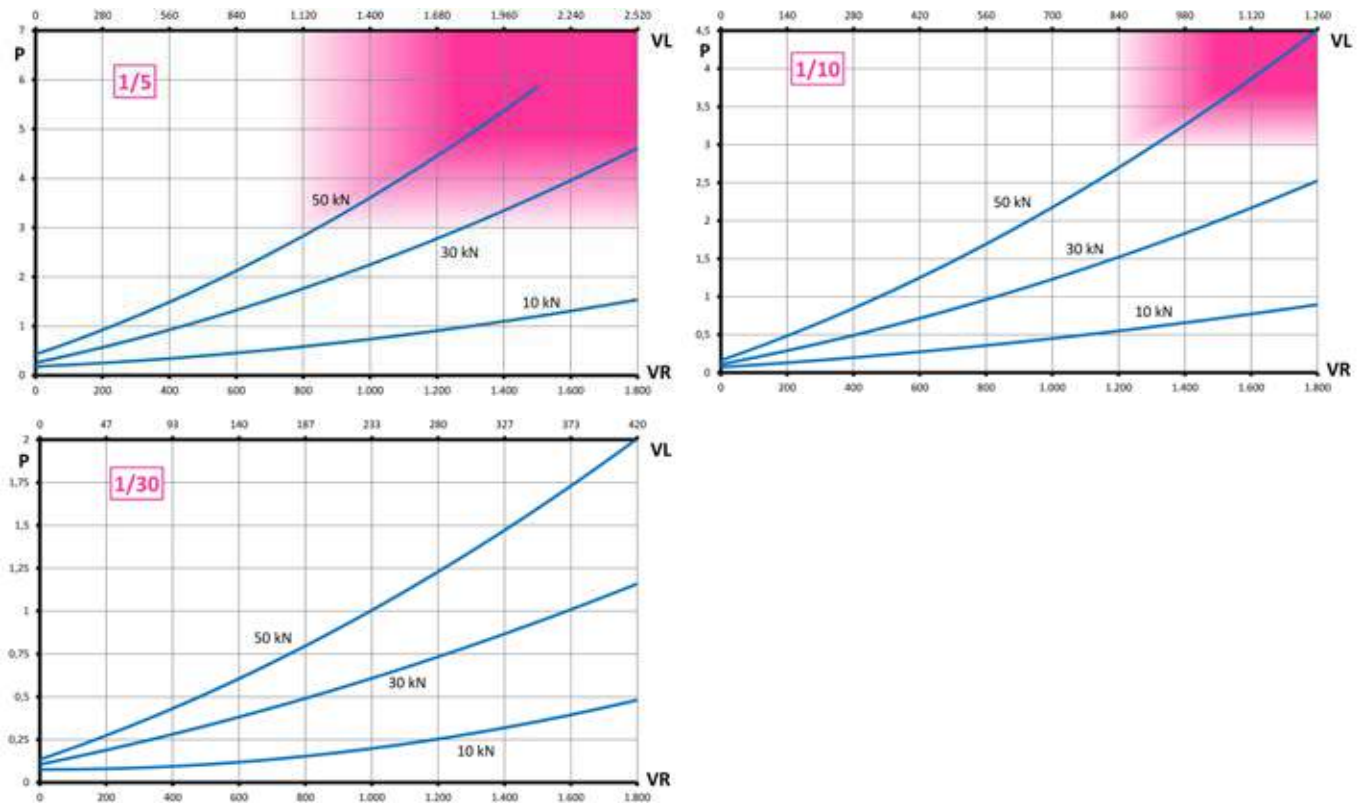
P = Requested input power [kW]



Motor Models

	IEC	Worm screw bore diameter	Centering diameter	Nominal power (4 poles motor)
	IEC 90 B5 / B14	24 mm	130 mm / 95 mm	1,9 kW
	IEC 100-112 B5 / B14	28 mm	180 mm / 110 mm	5 kW
	IEC 132 B5 / B14	38 mm	230 mm / 130 mm	9,2 kW

Construction Forms



Size 559 - 10 ton - 100 kN

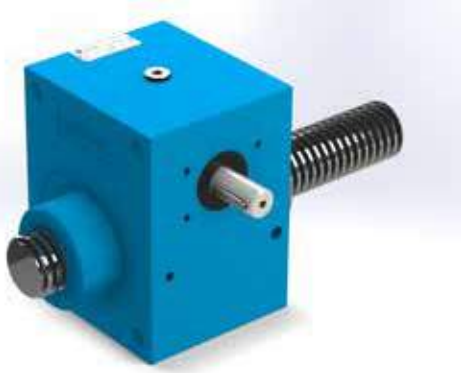

TP Model

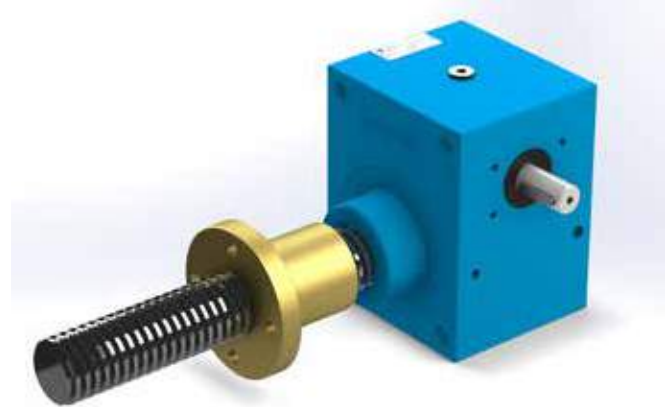

TPR Model

Materials

	Material	Norms	Specs	Indications
Worm	16NiCr4	EN 10084:2008	Casehardening alloy steel	Casehardened and ground on teeth and holds
Worm wheel	CuAl10Fe2-GM	EN 1982:2008	Aluminium bronze	Chill molded
Nut	CuAl10Fe2-GM	EN 1982:2008	Aluminium bronze	Chill molded
Spindle	C45	EN 10083-2:2006	Carbon steel	Tr 55x9 (ISO 2901:2016) - Rolled or machined
Carter	GJL 250	EN 1561:2011	Grey cast iron	Completely machined on 6 faces
Lubricant	Unimec Mark CA		Calcium based grease	1 kg

General features

Operating Temperature	-10 °C / 80 °C
Static Load (traction or compression)	150 kN
Dynamic Load (traction or compression)	100 kN
Max input speed	1800 rpm
Main Gearbox Weight	34 kg
Trapezoidal Screw Weight	18 kg/m
Anti-Rotation Torque with Max Load	446 Nm
Max admissible lateral loads	1 kN
Center-to-center distance	70 mm
Max radial Load on worm Screw	600 N
Standard Working Conditions	25 °C - service 10%

Euler's law (safety factor =2; dynamic compression load)
 Limit Load 1 (red) - 2 (blue) - 3 (green)
 C = Load [kN]
 L = Overall trapezoidal screw length [mm]

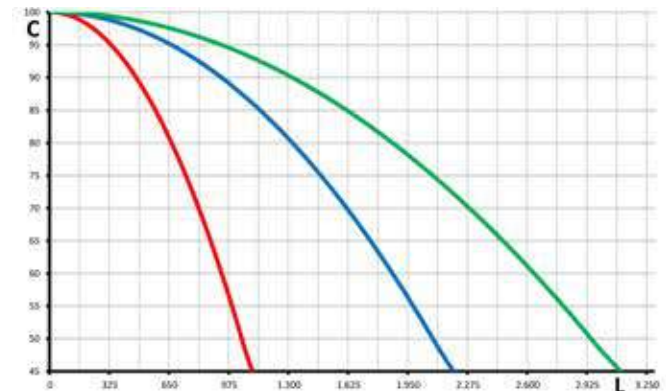

Specific features

	Nominal Ratios		
	1/5	1/10	1/30
Real ratio	1/5	1/10	1/30
Translation per worm revolution	1,8 mm	0,9 mm	0,3 mm
Efficiency	25 %	22 %	17 %
Start-up efficiency	18 %	15 %	12 %
Maximum linear speed	2700	1620	540
Torque at maximum load	115 Nm	65 Nm	28 Nm
Worm screw maximum torque	490 Nm	128 Nm	154 Nm
Loadless torque	2,2 Nm	1,7 Nm	1 Nm

Power curves

The magenta zone indicates a potential heating risk. Working cycles must be carefully analyzed.



VR = Worm rotational speed [rpm]

VL = Spindle translation speed [mm/min]

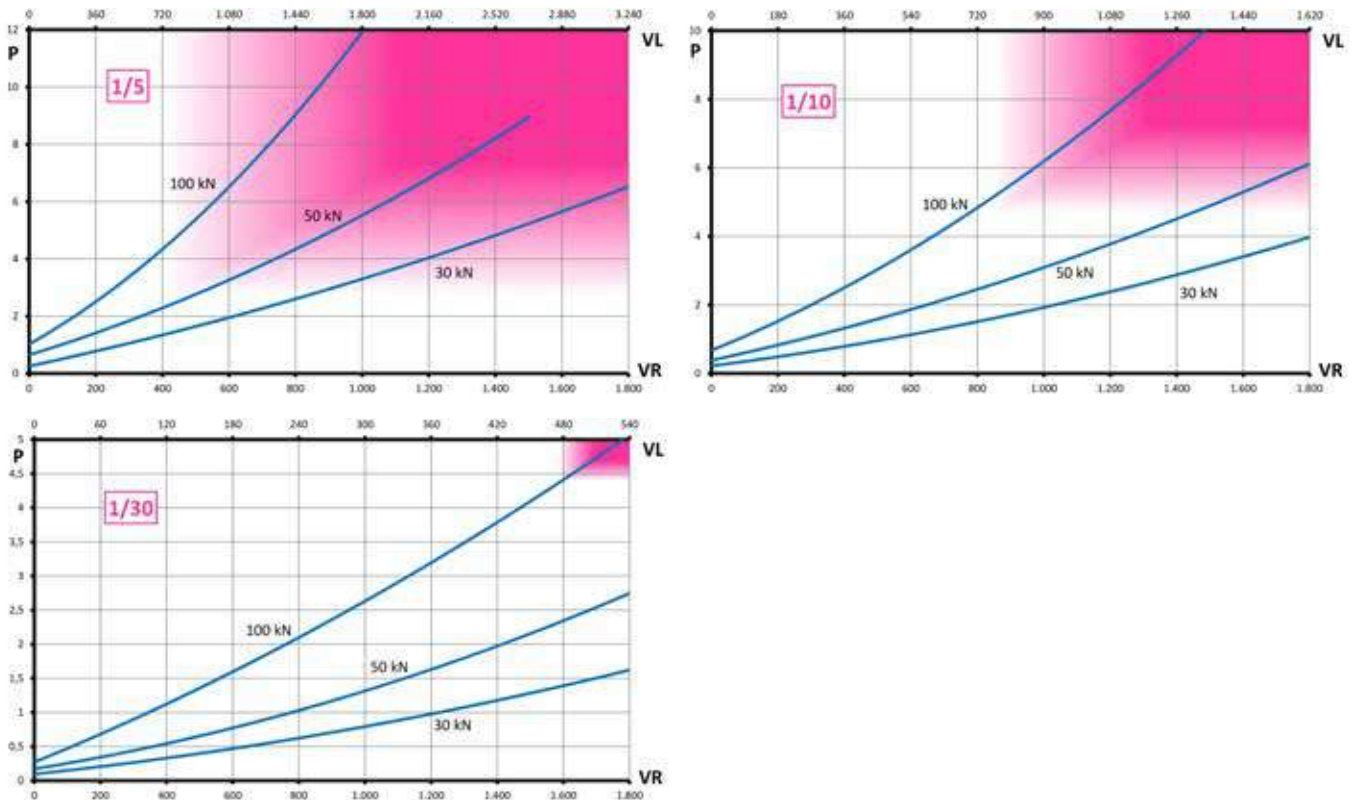
P = Requested input power [kW]



Motor Models

	IEC	Worm screw bore diameter	Centering diameter	Nominal power (4 poles motor)
	IEC 71 B5	11 mm	110 mm	0,55 kW
	IEC 80 B5 / B14	19 mm	130 mm / 80 mm	1,1 kW
	IEC 90 B5 / B14	24 mm	130 mm / 95 mm	1,9 kW
	IEC 100-112 B5 / B14	28 mm	180 mm / 110 mm	5 kW
	IEC 132 B5 / B14	38 mm	230 mm / 130 mm	9,2 kW

Construction Forms



Size 7010 - 20 ton - 200 kN



TP Model

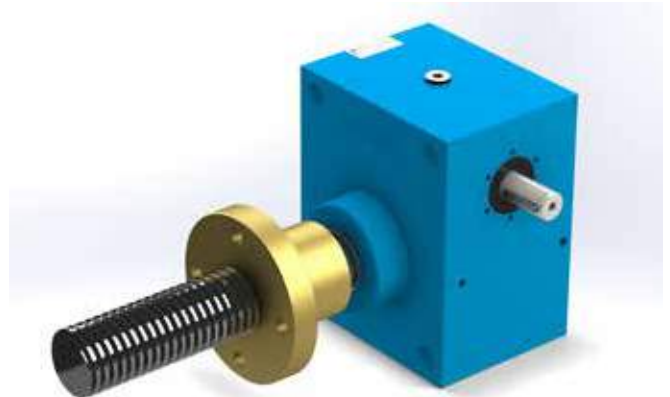

TPR Model

Materials

	Material	Norms	Specs	Indications
Worm	16NiCr4	EN 10084:2008	Casehardening alloy steel	Casehardened and ground on teeth and holds
Worm wheel	CuAl10Fe2-GM	EN 1982:2008	Aluminium bronze	Chill molded
Nut	CuAl10Fe2-GM	EN 1982:2008	Aluminium bronze	Chill molded
Spindle	C45	EN 10083-2:2006	Carbon steel	Tr 70x10 (ISO 2901:2016) - Rolled or machined
Carter	GJL 250	EN 1561:2011	Grey cast iron	Completely machined on 6 faces
Lubricant	Unimec Mark CA		Calcium based grease	2 kg

General features

Operating Temperature	-10 °C / 80 °C
Static Load (traction or compression)	280 kN
Dynamic Load (traction or compression)	200 kN
Max input speed	1800 rpm
Main Gearbox Weight	56 kg
Trapezoidal Screw Weight	28 kg/m
Anti-Rotation Torque with Max Load	1100 Nm
Max admissible lateral loads	3 kN
Center-to-center distance	90 mm
Max radial Load on worm Screw	900 N
Standard Working Conditions	25 °C - service 10%

Euler's law (safety factor =2; dynamic compression load)
 Limit Load 1 (red) - 2 (blue) - 3 (green)
 C = Load [kN]
 L = Overall trapezoidal screw length [mm]

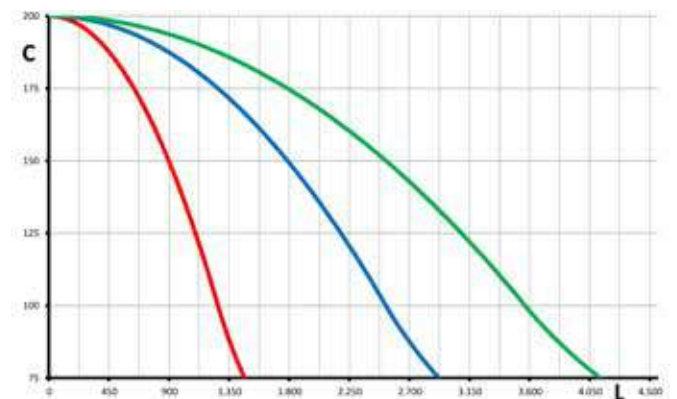

Specific features

	Nominal Ratios		
	1/5	1/10	1/30
Real ratio	1/5,2	1/9,67	1/30
Translation per worm revolution	1,92 mm	1,03 mm	0,33 mm
Efficiency	23 %	21 %	14 %
Start-up efficiency	15 %	14 %	9 %
Maximum linear speed	3600	1800	600
Torque at maximum load	280 Nm	150 Nm	75 Nm
Worm screw maximum torque	850 Nm	850 Nm	490 Nm
Loadless torque	3,5 Nm	2,7 Nm	1,95 Nm

Power curves

The magenta zone indicates a potential heating risk. Working cycles must be carefully analyzed.



VR = Worm rotational speed [rpm]

VL = Spindle translation speed [mm/min]

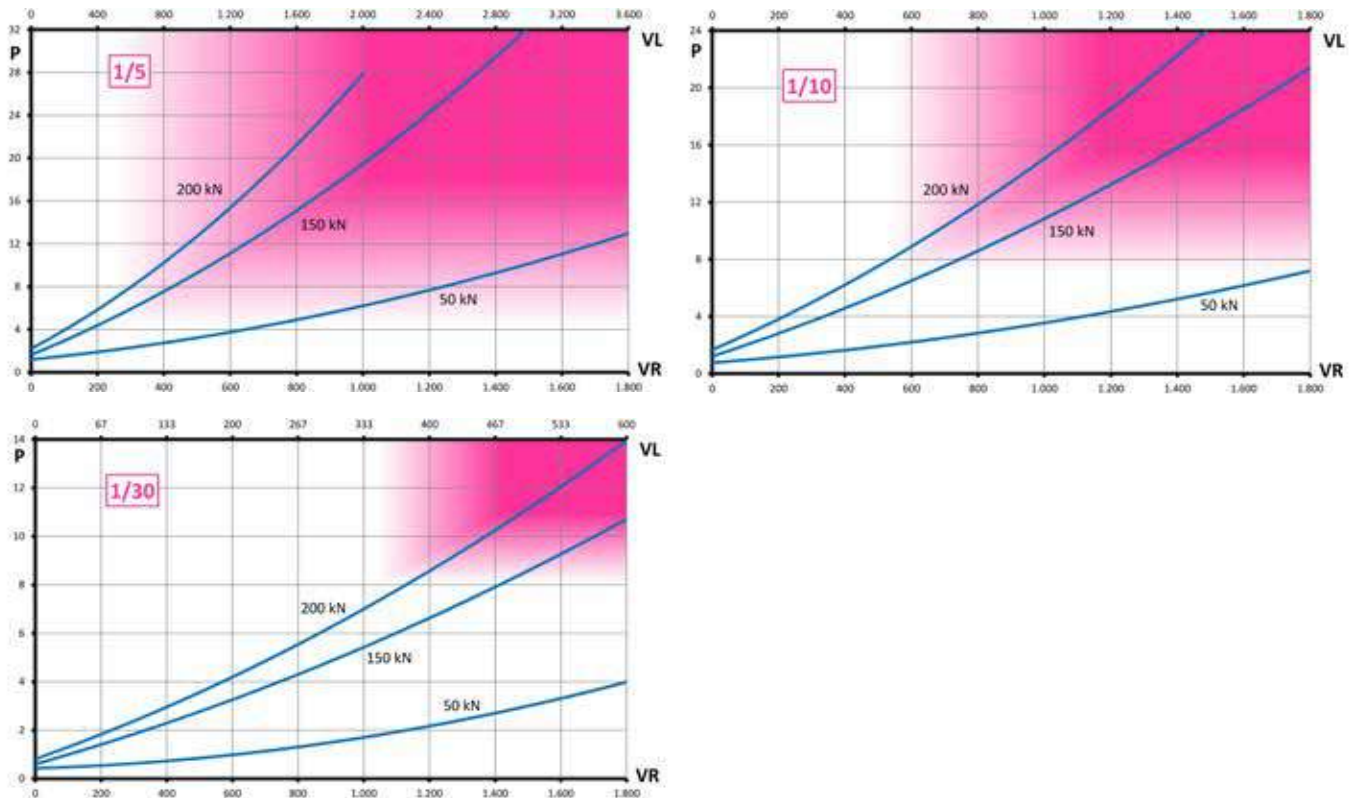
P = Requested input power [kW]



Motor Models

	IEC	Worm screw bore diameter	Centering diameter	Nominal power (4 poles motor)
	IEC 132 B5 / B14	38 mm	230 mm / 130 mm	9,2 kW
	IEC 160 B5 / B14	42 mm	250 mm / 180 mm	15 kW
	IEC 180 B5	48 mm	250 mm	22 kW

Construction Forms



Size 8010 - 25 ton - 250 kN



TP Model

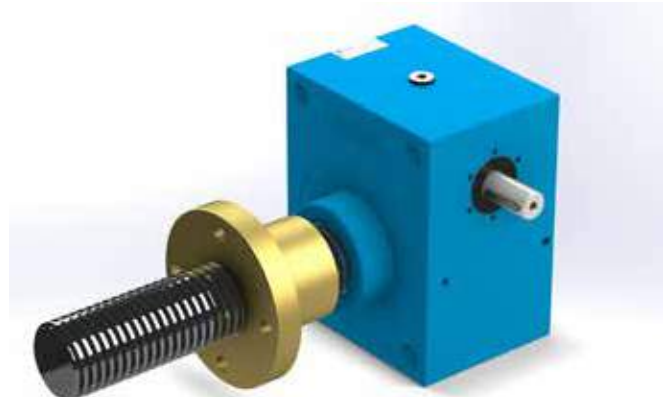

TPR Model

Materials

	Material	Norms	Specs	Indications
Worm	16NiCr4	EN 10084:2008	Casehardening alloy steel	Casehardened and ground on teeth and holds
Worm wheel	CuAl10Fe2-GM	EN 1982:2008	Aluminium bronze	Chill molded
Nut	CuAl10Fe2-GM	EN 1982:2008	Aluminium bronze	Chill molded
Spindle	C45	EN 10083-2:2006	Carbon steel	Tr 80x10 (ISO 2901:2016) - Rolled or machined
Carter	GJL 250	EN 1561:2011	Grey cast iron	Completely machined on 6 faces
Lubricant	Unimec Mark CA		Calcium based grease	2 kg

General features

Static Load (traction or compression)	350 kN
Dynamic Load (traction or compression)	250 kN
Max input speed	1800 rpm
Main Gearbox Weight	62 kg
Trapezoidal Screw Weight	37 kg/m
Anti-Rotation Torque with Max Load	1530 Nm
Max admissible lateral loads	4 kN
Center-to-center distance	90 mm
Max radial Load on worm Screw	900 N
Standard Working Conditions	25 °C - service 10%

Euler's law (safety factor =2; dynamic compression load)

Limit Load 1 (red) - 2 (blue) - 3 (green)

C = Load [kN]

L = Overall trapezoidal screw length [mm]

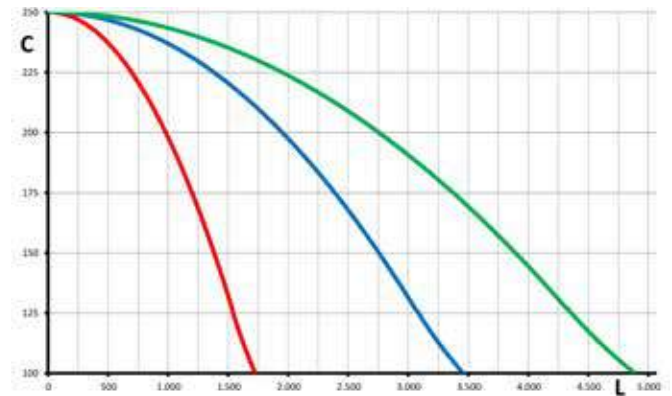

Specific features

	Nominal Ratios		
	1/5	1/10	1/30
Real ratio	1/5,2	1/9,67	1/30
Translation per worm revolution	1,92 mm	1,03 mm	0,33 mm
Efficiency	22 %	20 %	14 %
Start-up efficiency	14 %	13 %	9 %
Maximum linear speed	2000	1500	600
Torque at maximum load	360 Nm	200 Nm	95 Nm
Worm screw maximum torque	850 Nm	850 Nm	490 Nm
Loadless torque	3,5 Nm	2,7 Nm	1,95 Nm

Power curves

The magenta zone indicates a potential heating risk. Working cycles must be carefully analyzed.



VR = Worm rotational speed [rpm]

VL = Spindle translation speed [mm/min]

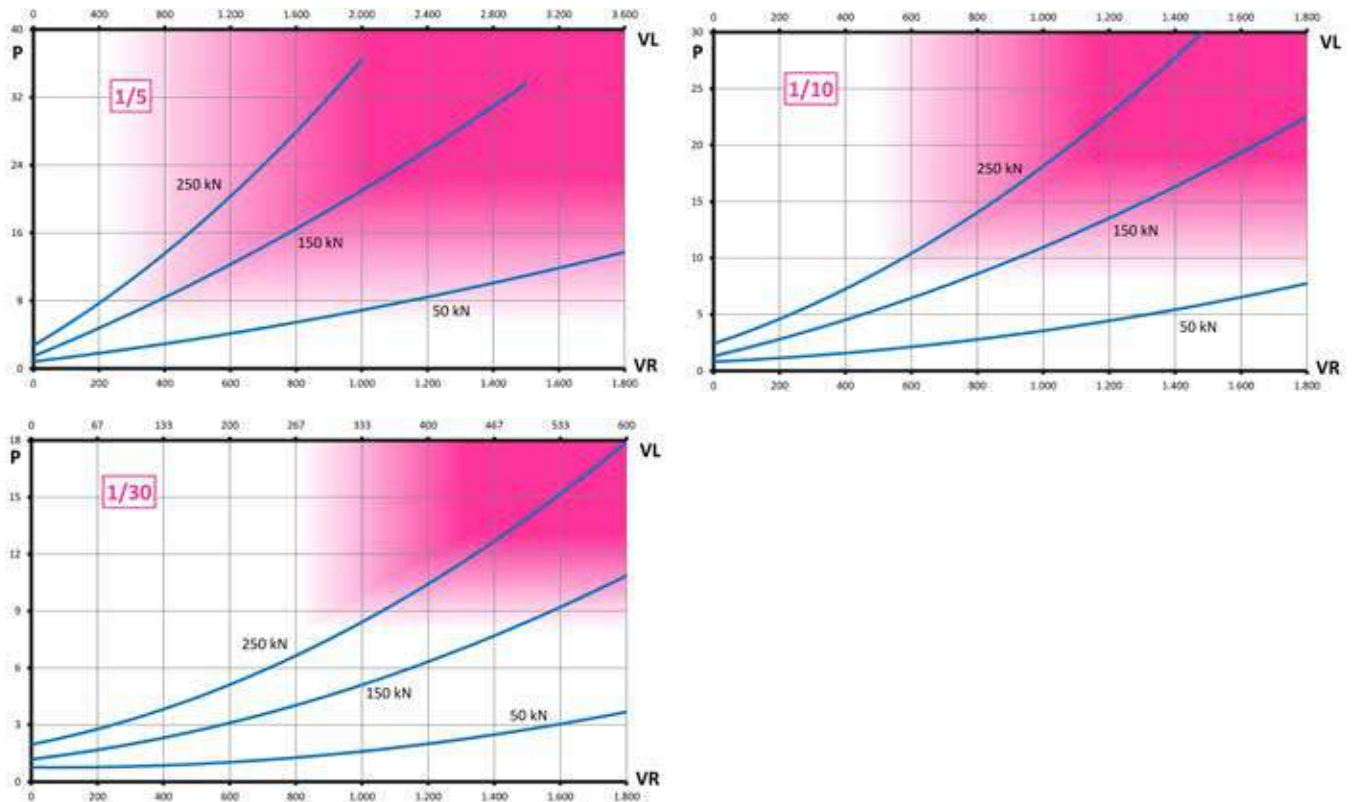
P = Requested input power [kW]



Motor Models

	IEC	Worm screw bore diameter	Centering diameter	Nominal power (4 poles motor)
	IEC 100-112 B5 / B14	28 mm	180 mm / 110 mm	5 kW
	IEC 132 B5 / B14	38 mm	230 mm / 130 mm	9,2 kW
	IEC 160 B5 / B14	42 mm	250 mm / 180 mm	15 kW
	IEC 180 B5	48 mm	250 mm	22 kW

Construction Forms



Size 9010 - 35 ton - 350 kN



TP Model

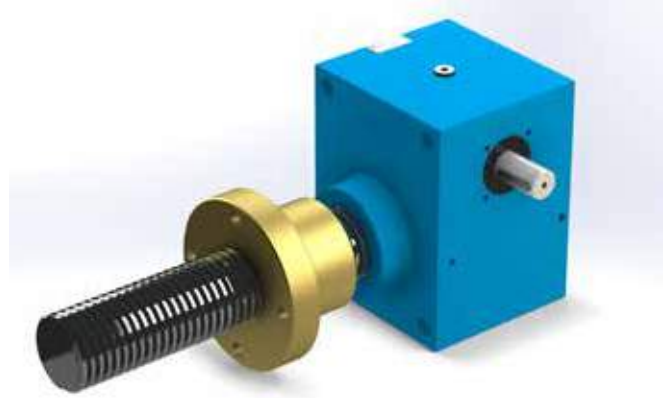

TPR Model

Materials

	Material	Norms	Specs	Indications
Worm	16NiCr4	EN 10084:2008	Casehardening alloy steel	Casehardened and ground on teeth and holds
Worm wheel	CuAl10Fe2-GZ	EN 1982:2008	Aluminium bronze	Centrifuged
Nut	CuAl10Fe2-GZ	EN 1982:2008	Aluminium bronze	Centrifuged
Spindle	C45	EN 10083-2:2006	Carbon steel	Tr 100x12 (ISO 2901:2016) - Rolled or machined
Carter	GJL 250	EN 1561:2011	Grey cast iron	Completely machined on 6 faces
Lubricant	Unimec Mark CA		Calcium based grease	2,3 kg

General features

Operating Temperature	-10 °C / 80 °C
Static Load (traction or compression)	500 kN
Dynamic Load (traction or compression)	350 kN
Max input speed	1800 rpm
Main Gearbox Weight	110 kg
Trapezoidal Screw Weight	56 kg/m
Anti-Rotation Torque with Max Load	2650 Nm
Max admissible lateral loads	8 kN
Center-to-center distance	110 mm
Max radial Load on worm Screw	1 kN
Standard Working Conditions	25 °C - service 10%

Euler's law (safety factor =2; dynamic compression load)

Limit Load 1 (red) - 2 (blue) - 3 (green)

C = Load [kN]

L = Overall trapezoidal screw length [mm]

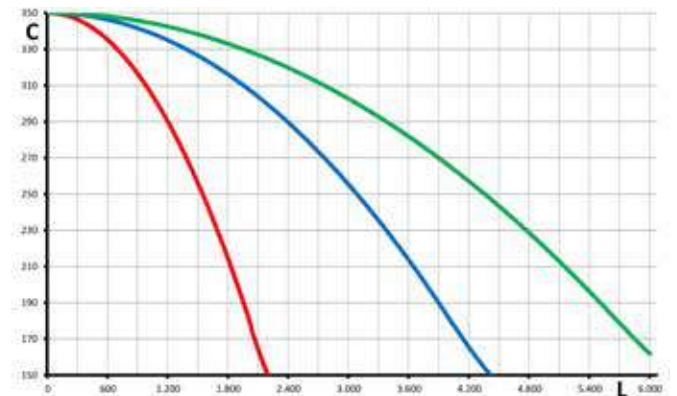

Specific features

	Nominal Ratios	
	1/10	1/30
Real ratio	1/10	1/30
Translation per worm revolution	1,2 mm	0,4 mm
Efficiency	18 %	12 %
Start-up efficiency	12 %	8 %
Maximum linear speed	1800	720
Torque at maximum load	370 Nm	185 Nm
Worm screw maximum torque	2000 Nm	2000 Nm
Loadless torque	3,25 Nm	2,3 Nm

> Power curves

The magenta zone indicates a potential heating risk. Working cycles must be carefully analyzed.

VR = Worm rotational speed [rpm]

VL = Spindle translation speed [mm/min]

P = Requested input power [kW]

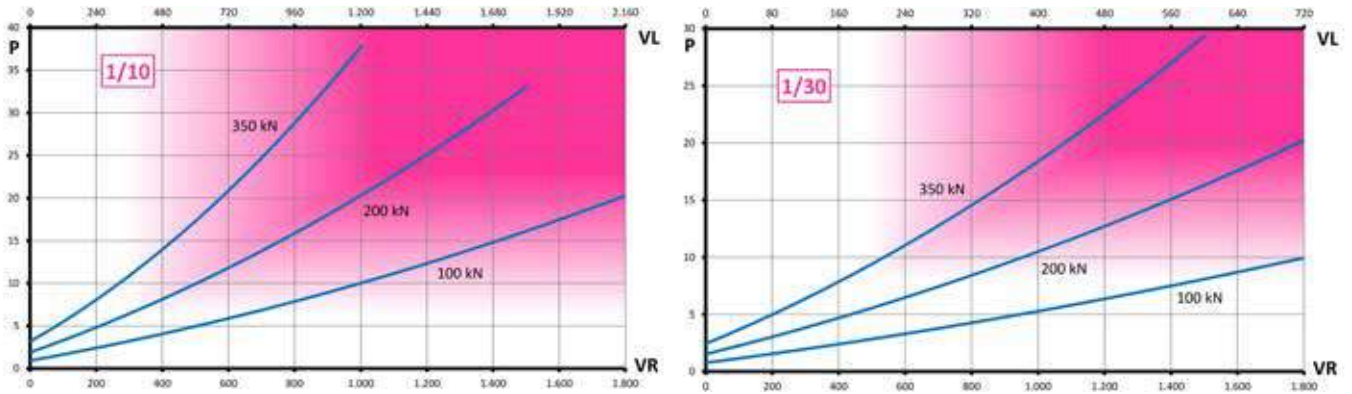

> Construction Forms



Form B



Form D



Form S



Form B



Form D



Form S



Size 10012 - 40 ton - 400 kN



Model TP



Model TPR

Materials

	Material	Norms	Specs	Indications
Worm	16NiCr4	EN 10084:2008	Casehardening alloy steel	Casehardened and ground on teeth and holds
Worm wheel	CuAl10Fe2-GZ	EN 1982:2008	Aluminium bronze	Centrifuged
Nut	CuAl10Fe2-GZ	EN 1982:2008	Aluminium bronze	Centrifuged
Spindle	C45	EN 10083-2:2006	Carbon steel	Tr 100x12 (ISO 2901:2016) - Rolled or machined
Carter	S235 J0	EN 10025-2:2005	Welded carbon steel	Completely machined on 6 faces
Lubricant	Unimec Mark CA		Calcium based grease	3,7 kg

General features

Operating Temperature	-10 °C / 80 °C
Static Load (traction or compression)	600 kN
Dynamic Load (traction or compression)	400 kN
Max input speed	1800 rpm
Main Gearbox Weight	180 kg
Trapezoidal Screw Weight	56 kg/m
Anti-Rotation Torque with Max Load	3030 Nm
Max admissible lateral loads	8 kN
Center-to-center distance	140 mm
Max radial Load on worm Screw	2,5 kN
Standard Working Conditions	25 °C - service 10%

Euler's law (safety factor =2; dynamic compression load)
 Limit Load 1 (red) - 2 (blue) - 3 (green)
 C = Load [kN]
 L = Overall trapezoidal screw length [mm]

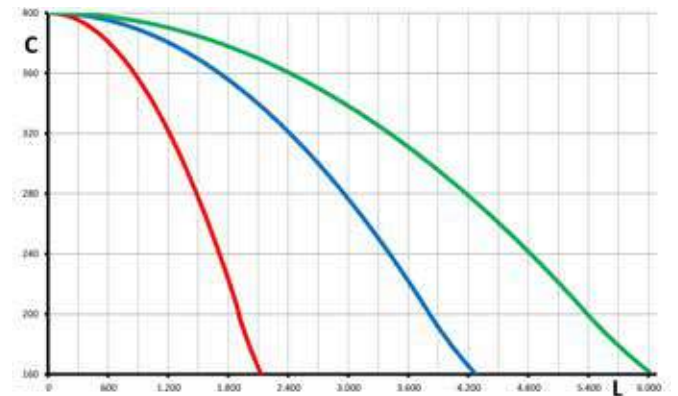

Specific features

	Nominal Ratios	
	1/10	1/30
Real ratio	1/10,33	1/30
Translation per worm revolution	1,16 mm	0,4 mm
Efficiency	18 %	12 %
Start-up efficiency	12 %	8 %
Maximum linear speed	1200	720
Torque at maximum load	425 Nm	210 Nm
Worm screw maximum torque	5200 Nm	4400 Nm
Loadless torque	3,95 Nm	3 Nm

› Power curves

The magenta zone indicates a potential heating risk. Working cycles must be carefully analyzed.

VR = Worm rotational speed [rpm]

VL = Spindle translation speed [mm/min]

P = Requested input power [kW]

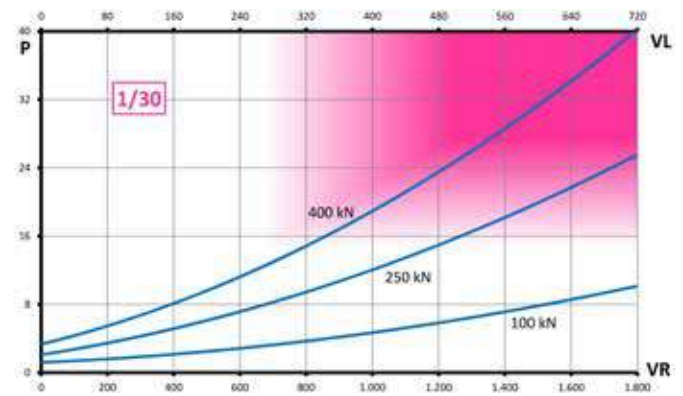
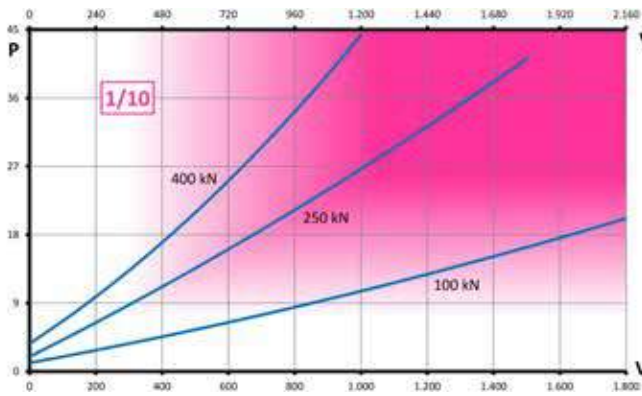

› Construction Forms



Form B



Form D



Form S



Form B



Form D



Form S

Size 12014 - 60 ton - 600 kN



TP Model



TPR Model

Materials

	Material	Norms	Specs	Indications
Worm	16NiCr4	EN 10084:2008	Casehardening alloy steel	Casehardened and ground on teeth and holds
Worm wheel	CuAl10Fe2-GZ	EN 1982:2008	Aluminium bronze	Centrifuged
Nut	CuAl10Fe2-GZ	EN 1982:2008	Aluminium bronze	Centrifuged
Spindle	C45	EN 10083-2:2006	Carbon steel	Tr 120x14 (ISO 2901:2016) - Rolled or machined
Carter	S235 J0	EN 10025-2:2005	Welded carbon steel	Completely machined on 6 faces
Lubricant	Unimec Mark CA		Calcium based grease	3,7 kg

General features

Operating Temperature	-10 °C / 80 °C
Static Load (traction or compression)	850 kN
Dynamic Load (traction or compression)	600 kN
Max input speed	1800 rpm
Main Gearbox Weight	180 kg
Trapezoidal Screw Weight	81 kg/m
Anti-Rotation Torque with Max Load	5430 Nm
Max admissible lateral loads	10 kN
Center-to-center distance	140 mm
Max radial Load on worm Screw	2,5 kN
Standard Working Conditions	25 °C - service 10%

Euler's law (safety factor =2; dynamic compression load)
 Limit Load 1 (red) - 2 (blue) - 3 (green)
 C = Load [kN]
 L = Overall trapezoidal screw length [mm]

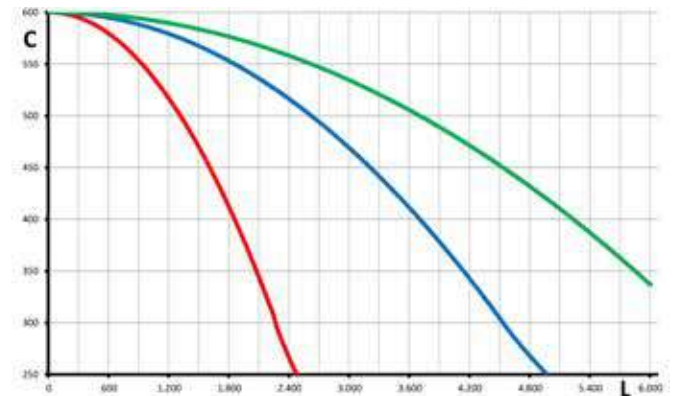

Specific features

	Nominal Ratios	
	1/10	1/30
Real ratio	1/10,33	1/30
Translation per worm revolution	1,355 mm	0,47 mm
Efficiency	17 %	11 %
Start-up efficiency	11 %	7 %
Maximum linear speed	1050	700
Torque at maximum load	800 Nm	400 Nm
Worm screw maximum torque	5200 Nm	4400 Nm
Loadless torque	3,95 Nm	3 Nm

› Power curves

The magenta zone indicates a potential heating risk. Working cycles must be carefully analyzed.

VR = Worm rotational speed [rpm]

VL = Spindle translation speed [mm/min]

P = Requested input power [kW]

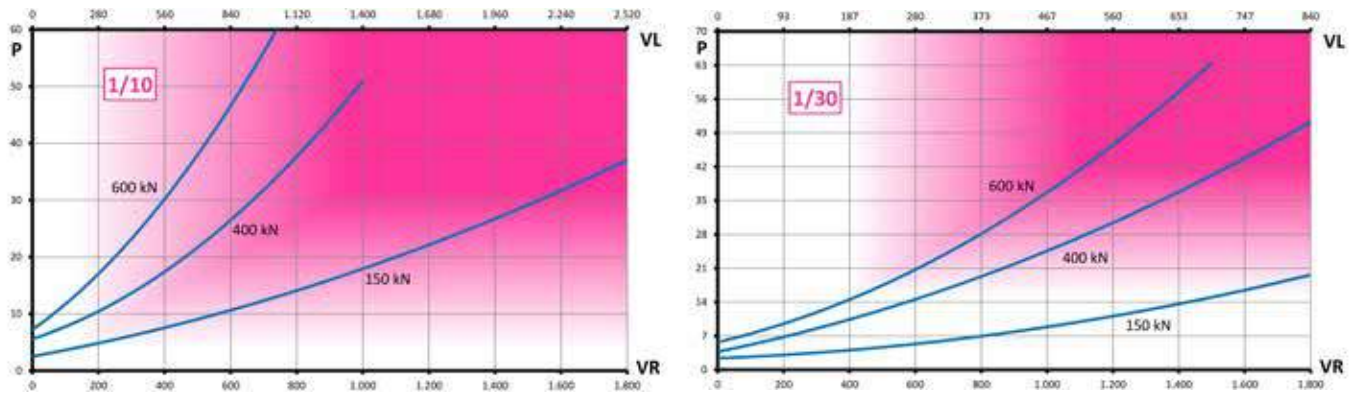

› Construction Forms



Form B



Form D

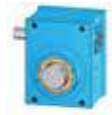

Form S



Form B



Form D



Form S



Size 14014 - 80 ton - 800 kN



TP Model



TPR Model

Materials

	Material	Norms	Specs	Indications
Worm	16NiCr4	EN 10084:2008	Casehardening alloy steel	Casehardened and ground on teeth and holds
Worm wheel	CuAl10Fe2-GZ	EN 1982:2008	Aluminium bronze	Centrifuged
Nut	CuAl10Fe2-GZ	EN 1982:2008	Aluminium bronze	Centrifuged
Spindle	C45	EN 10083-2:2006	Carbon steel	Tr 140x14 (ISO 2901:2016) - Rolled or machined
Carter	S235 J0	EN 10025-2:2005	Welded carbon steel	Completely machined on 6 faces
Lubricant	Unimec Mark CA		Calcium based grease	14 kg

General features

Operating Temperature	-10 °C / 80 °C
Static Load (traction or compression)	1200 kN
Dynamic Load (traction or compression)	800 kN
Max input speed	1800 rpm
Main Gearbox Weight	550 kg
Trapezoidal Screw Weight	110 kg/m
Anti-Rotation Torque with Max Load	8100 Nm
Max admissible lateral loads	20 kN
Center-to-center distance	200 mm
Max radial Load on worm Screw	3 kN
Standard Working Conditions	25 °C - service 10%

Euler's law (safety factor =2; dynamic compression load)

Limit Load 1 (red) - 2 (blue) - 3 (green)

C = Load [kN]

L = Overall trapezoidal screw length [mm]

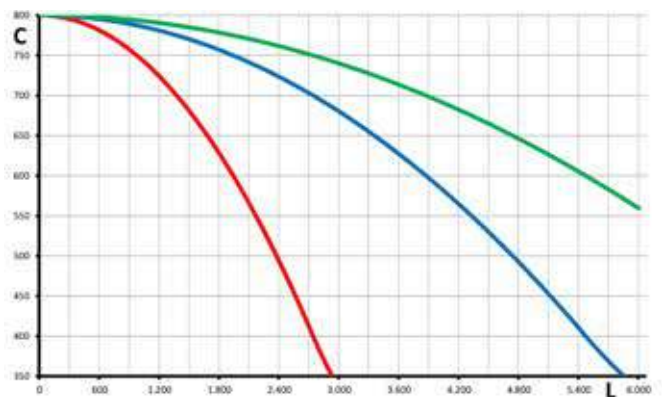

Specific features

	Nominal Ratios	
	1/12	1/36
Real ratio	1/12	1/36
Translation per worm revolution	1,16 mm	0,38 mm
Efficiency	16 %	10 %
Start-up efficiency	10 %	6 %
Maximum linear speed	1200	600
Torque at maximum load	930 Nm	500 Nm
Worm screw maximum torque	8200 Nm	9800 Nm
Loadless torque	7,2 Nm	5 Nm

› Power curves

The magenta zone indicates a potential heating risk. Working cycles must be carefully analyzed.

VR = Worm rotational speed [rpm]

VL = Spindle translation speed [mm/min]

P = Requested input power [kW]

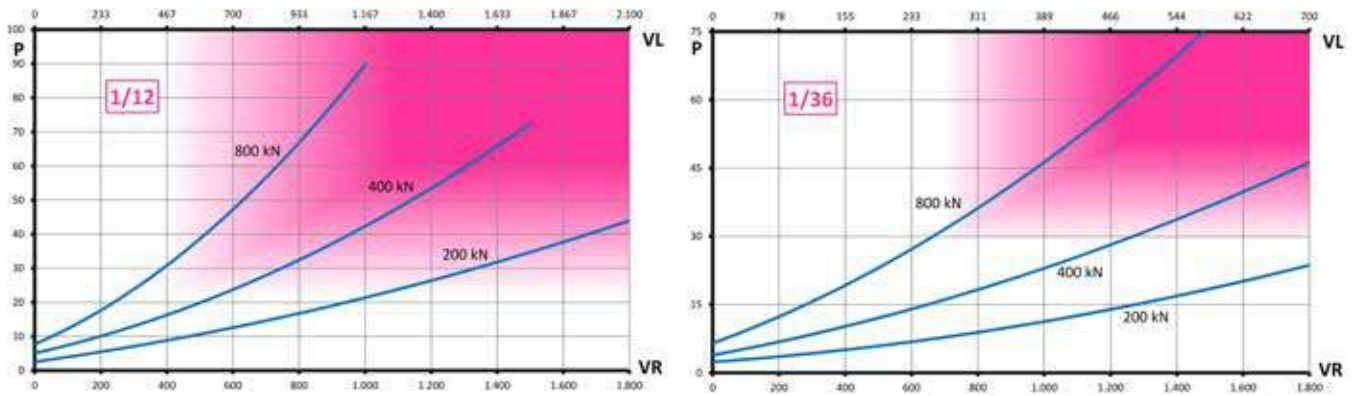

› Construction Forms



Form B



Form D



Form S



Form B



Form D



Form S

Size 16016 - 100 ton - 1000 kN



TP Model

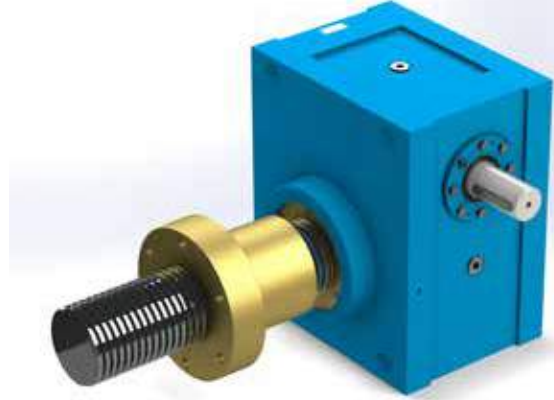

TPR Model

Materials

	Material	Norms	Specs	Indications
Worm	16NiCr4	EN 10084:2008	Casehardening alloy steel	Casehardened and ground on teeth and holds
Worm wheel	CuAl10Fe2-GZ	EN 1982:2008	Aluminium bronze	Centrifuged
Nut	CuAl10Fe2-GZ	EN 1982:2008	Aluminium bronze	Centrifuged
Spindle	C45	EN 10083-2:2006	Carbon steel	Tr 160x16 (ISO 2901:2016) - Rolled or machined
Carter	S235 J0	EN 10025-2:2005	Welded carbon steel	Completely machined on 6 faces
Lubricant	Unimec Mark CA		Calcium based grease	14 kg

General features

Operating Temperature	-10 °C / 80 °C
Static Load (traction or compression)	1500 kN
Dynamic Load (traction or compression)	1000 kN
Max input speed	1800 rpm
Main Gearbox Weight	550 kg
Trapezoidal Screw Weight	140 kg/m
Anti-Rotation Torque with Max Load	11700 Nm
Max admissible lateral loads	25 kN
Center-to-center distance	200 mm
Max radial Load on worm Screw	3 kN
Standard Working Conditions	25 °C - service 10%

Euler's law (safety factor =2; dynamic compression load)
 Limit Load 1 (red) - 2 (blue) - 3 (green)
 C = Load [kN]
 L = Overall trapezoidal screw length [mm]

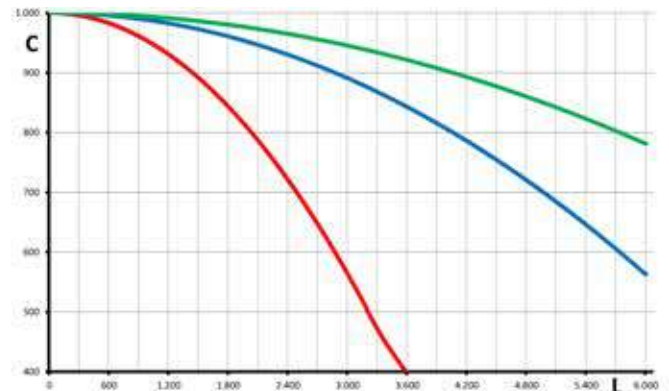

Specific features

	Nominal Ratios	
	1/12	1/36
Real ratio	1/12	1/36
Translation per worm revolution	1,33 mm	0,44 mm
Efficiency	15 %	9 %
Start-up efficiency	9 %	5 %
Maximum linear speed	1000	600
Torque at maximum load	1400 Nm	790 Nm
Worm screw maximum torque	8200 Nm	9800 Nm
Loadless torque	7,2 Nm	5 Nm

› Power curves

The magenta zone indicates a potential heating risk. Working cycles must be carefully analyzed.

VR = Worm rotational speed [rpm]

VL = Spindle translation speed [mm/min]

P = Requested input power [kW]

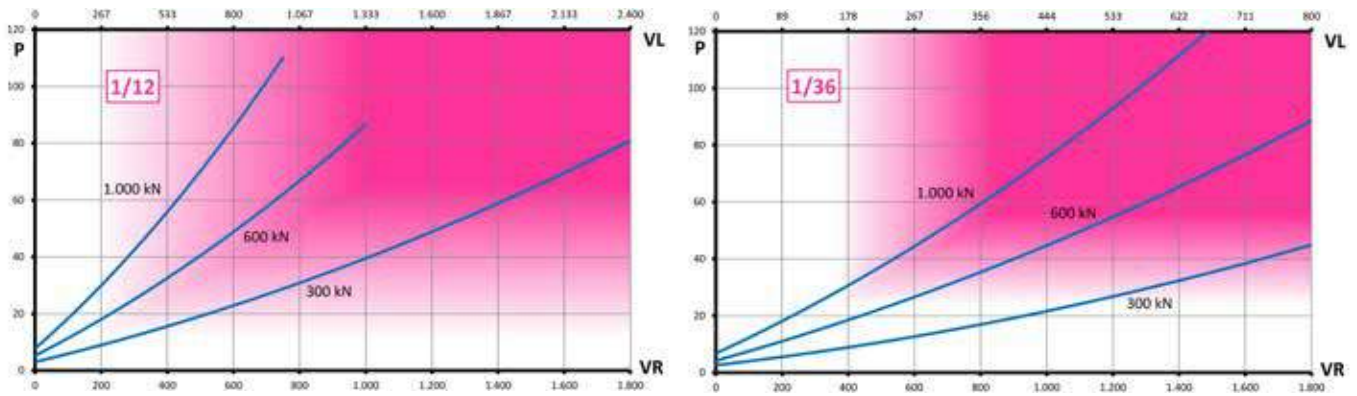

› Construction Forms



Form B



Form D



Form S



Form B



Form D



Form S

Size 20018 - 150 ton - 1500 kN



TP Model



TPR Model

Materials

	Material	Norms	Specs	Indications
Worm	16NiCr4	EN 10084:2008	Casehardening alloy steel	Casehardened and ground on teeth and holds
Worm wheel	CuAl10Fe2-GZ	EN 1982:2008	Aluminium bronze	Centrifuged
Nut	CuAl10Fe2-GZ	EN 1982:2008	Aluminium bronze	Centrifuged
Spindle	C45	EN 10083-2:2006	Carbon steel	Tr 200x18 (ISO 2901:2016) - Machined
Carter	S235 J0	EN 10025-2:2005	Welded carbon steel	Completely machined on 6 faces
Lubricant	Unimec Mark CA		Calcium based grease	28 kg

General features

Operating Temperature	-10 °C / 80 °C
Static Load (traction or compression)	2500 kN
Dynamic Load (traction or compression)	1500 kN
Max input speed	1800 rpm
Main Gearbox Weight	1200 kg
Trapezoidal Screw Weight	220 kg/m
Anti-Rotation Torque with Max Load	21500 Nm
Max admissible lateral loads	45 kN
Center-to-center distance	250 mm
Max radial Load on worm Screw	3,8 kN
Standard Working Conditions	25 °C - service 10%

Euler's law (safety factor =2; dynamic compression load)
 Limit Load 1 (red) - 2 (blue) - 3 (green)
 C = Load [kN]
 L = Overall trapezoidal screw length [mm]

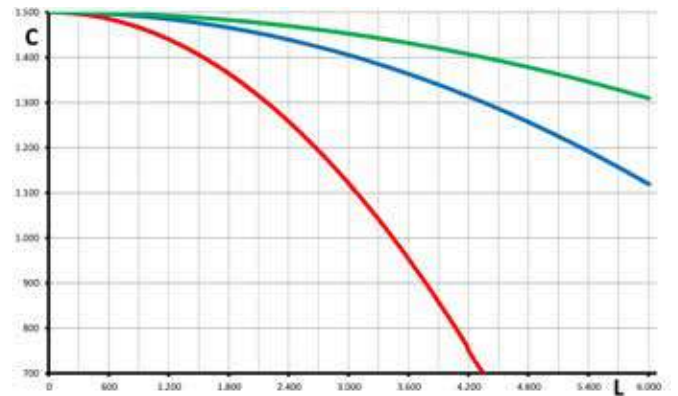

Specific features

	Nominal Ratios	
	1/12	1/36
Real ratio	1/12	1/36
Translation per worm revolution	1,5 mm	0,5 mm
Efficiency	14 %	9 %
Start-up efficiency	8 %	5 %
Maximum linear speed	1500	900
Torque at maximum load	2400 Nm	950 Nm
Worm screw maximum torque	28500 Nm	28500 Nm
Loadless torque	12 Nm	8 Nm

› Power curves

The magenta zone indicates a potential heating risk. Working cycles must be carefully analyzed.

VR = Worm rotational speed [rpm]

VL = Spindle translation speed [mm/min]

P = Requested input power [kW]

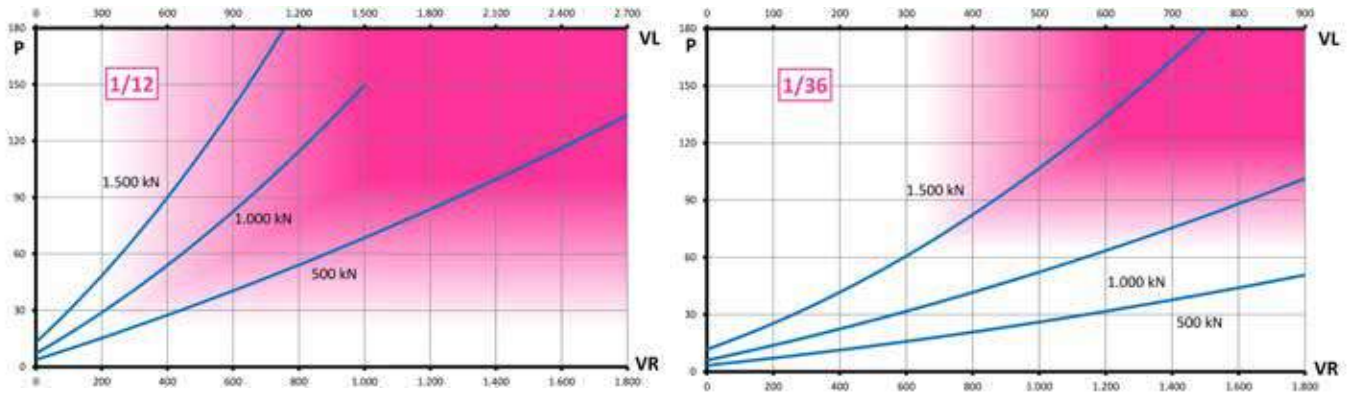

› Construction Forms



Form B



Form D



Form S



Form B



Form D



Form S

Size 25022 - 200 ton - 2000 kN



TP Model

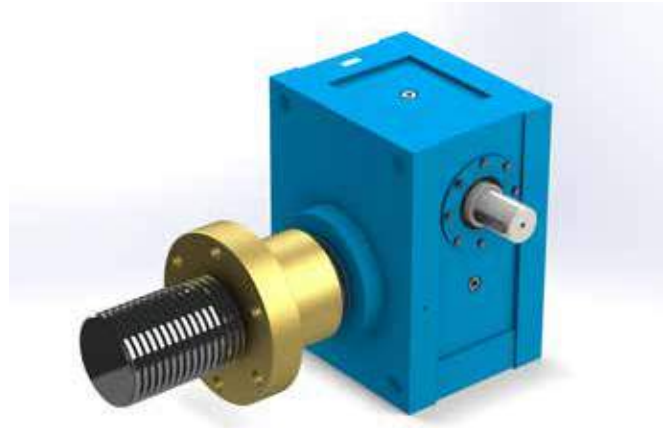

TPR Model

Materials

	Material	Norms	Specs	Indications
Worm	16NiCr4	EN 10084:2008	Casehardening alloy steel	Casehardened and ground on teeth and holds
Worm wheel	CuAl10Fe2-GZ	EN 1982:2008	Aluminium bronze	Centrifuged
Nut	CuAl10Fe2-GZ	EN 1982:2008	Aluminium bronze	Centrifuged
Spindle	C45	EN 10083-2:2006	Carbon steel	Tr 250x22 (ISO 2901:2016) - Machined
Carter	S235 J0	EN 10025-2:2005	Welded carbon steel	Completely machined on 6 faces
Lubricant	Unimec Mark CA		Calcium based grease	28 kg

General features

Operating Temperature	-10 °C / 80 °C
Carico statico (trazione o compressione)	3000 kN
Carico dinamico (trazione o compressione)	2000 kN
Max input speed	1800 rpm
Main Gearbox Weight	1200 kg
Trapezoidal Screw Weight	350 kg/m
Anti-Rotation Torque with Max Load	35800 Nm
Max admissible lateral loads	50 kN
Center-to-center distance	250 mm
Max radial Load on worm Screw	3,8 kN
Standard Working Conditions	25 °C - service 10%

Euler's law (safety factor =2; dynamic compression load)
 Limit Load 1 (red) - 2 (blue) - 3 (green)
 C = Load [kN]
 L = Overall trapezoidal screw length [mm]

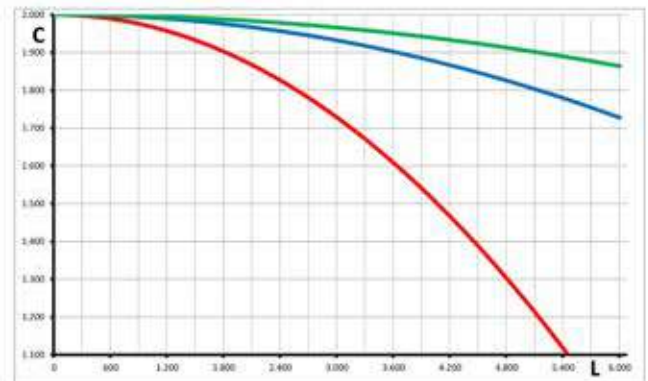

Specific features

	Nominal Ratios	
	1/12	1/36
Real ratio	1/12	1/36
Translation per worm revolution	1,83 mm	0,61 mm
Efficiency	14 %	9 %
Start-up efficiency	8 %	5 %
Maximum linear speed	1100	1375
Torque at maximum load	3700 Nm	1570 Nm
Worm screw maximum torque	28500 Nm	28500 Nm
Loadless torque	12 Nm	8 Nm

Power curves

The magenta zone indicates a potential heating risk. Working cycles must be carefully analyzed.

VR = Worm rotational speed [rpm]

VL = Spindle translation speed [mm/min]

P = Requested input power [kW]

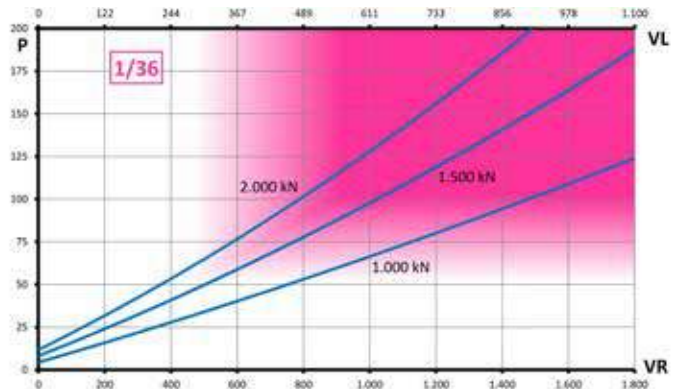
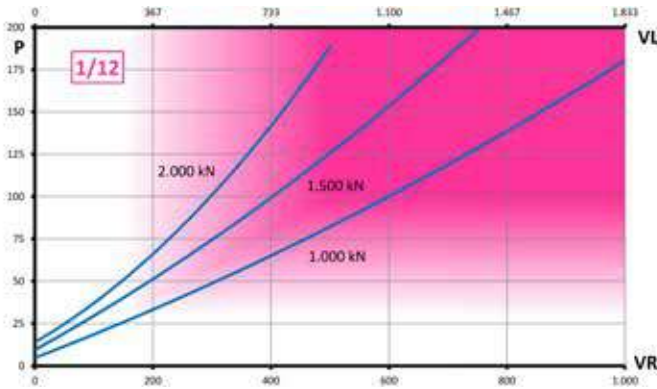

Construction Forms



Form B



Form D



Form S



Form B



Form D



Form S





Stainless Steel Trapezoidal Screw Jacks



The use of stainless steel has had an exponential growth in the last years. New market demands, hygienic requirements in food industry and the applications in oxidizing environments require an higher and higher employment of stainless materials.

From the beginning UNIMEC has been able to supply its products in stainless steel for its customers. Anyway, realizing those components meant long manufacturing times. For the most requested products and sizes UNIMEC is now able to propose a complete series: the X series. This choice gives multiple advantages: on the one hand a shortening of the delivery times as the components are all available on stock, on the other hand the manufacturing allows to obtain quite interesting costs, because it starts from the row casted pieces.

The main feature of an AISI 316 steel is its high resistance to corrosion, above all in the sea and food environments, where AISI 304 seems to have some problems.

X TYPE SCREW JACKS

Screw jacks belonging to the X series are sizes 204, 306, 407, in all the construction models. The components made of stainless steel are casings, bushings, covers, motor flanges, spindles and all end fittings.

The only component which is manufactured in non stainless steel is the worm screw. In case the screw tangs are exposed to oxidizing agents it is possible, on demand, to protect them by means of the Niploy treatment which has been described at the end of the trapezoidal screw jacks chapter.

Size 204 - 1 ton - 10 kN



XTP Model



XTPR Model

Materials

	Material	Norms	Specs	Indications
Worm	16NiCr4	EN 10084:2008	Casehardening alloy steel	Casehardened and ground on teeth and holds
Worm wheel	CuAl10Fe2-GM	EN 1982:2008	Aluminium bronze	Chill molded
Nut	CuAl10Fe2-GM	EN 1982:2008	Aluminium bronze	Chill molded
Spindle	X5 CrNiMo 17-12-2 (AISI 316)	EN 10088-1:2014	Stainless steel	Tr 20x4 (ISO 2901:2016) - Machined
Carter	X5 CrNiMo 17-12-2 (AISI 316)	EN 10088-1:2014	Stainless steel	Completely machined on 6 faces
Lubricant	Unimec Mark CA		Calcium based grease	0,1 kg

General features

Operating Temperature	-10 °C / 80 °C
Static Load (traction or compression)	20 kN
Dynamic Load (traction or compression)	10 kN
Max input speed	1800 rpm
Main Gearbox Weight	6 kg
Trapezoidal Screw Weight	2,22 kg/m
Anti-Rotation Torque with Max Load	17 Nm
Max admissible lateral loads	0 N
Center-to-center distance	30 mm
Max radial Load on worm Screw	220 N
Standard Working Conditions	25 °C - service 10%

Euler's law (safety factor =2; dynamic compression load)
 Limit Load 1 (red) - 2 (blue) - 3 (green)
 C = Load [kN]
 L = Overall trapezoidal screw length [mm]

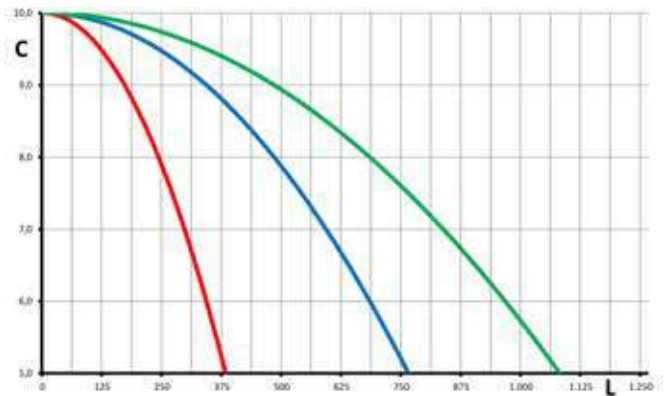

Specific features

	Nominal Ratios		
	1/5	1/10	1/30
Real ratio	1/4,75	1/10,5	1/30
Translation per worm revolution	0,842 mm	0,38 mm	0,13 mm
Efficiency	31 %	28 %	20 %
Start-up efficiency	22 %	19 %	14 %
Maximum linear speed	1440	720	240
Torque at maximum load	4,2 Nm	2,3 Nm	1,1 Nm
Worm screw maximum torque	54 Nm	54 Nm	42 Nm
Loadless torque	0,25 Nm	0,2 Nm	0,15 Nm

Power curves

The magenta zone indicates a potential heating risk. Working cycles must be carefully analyzed.



VR = Worm rotational speed [rpm]

VL = Spindle translation speed [mm/min]

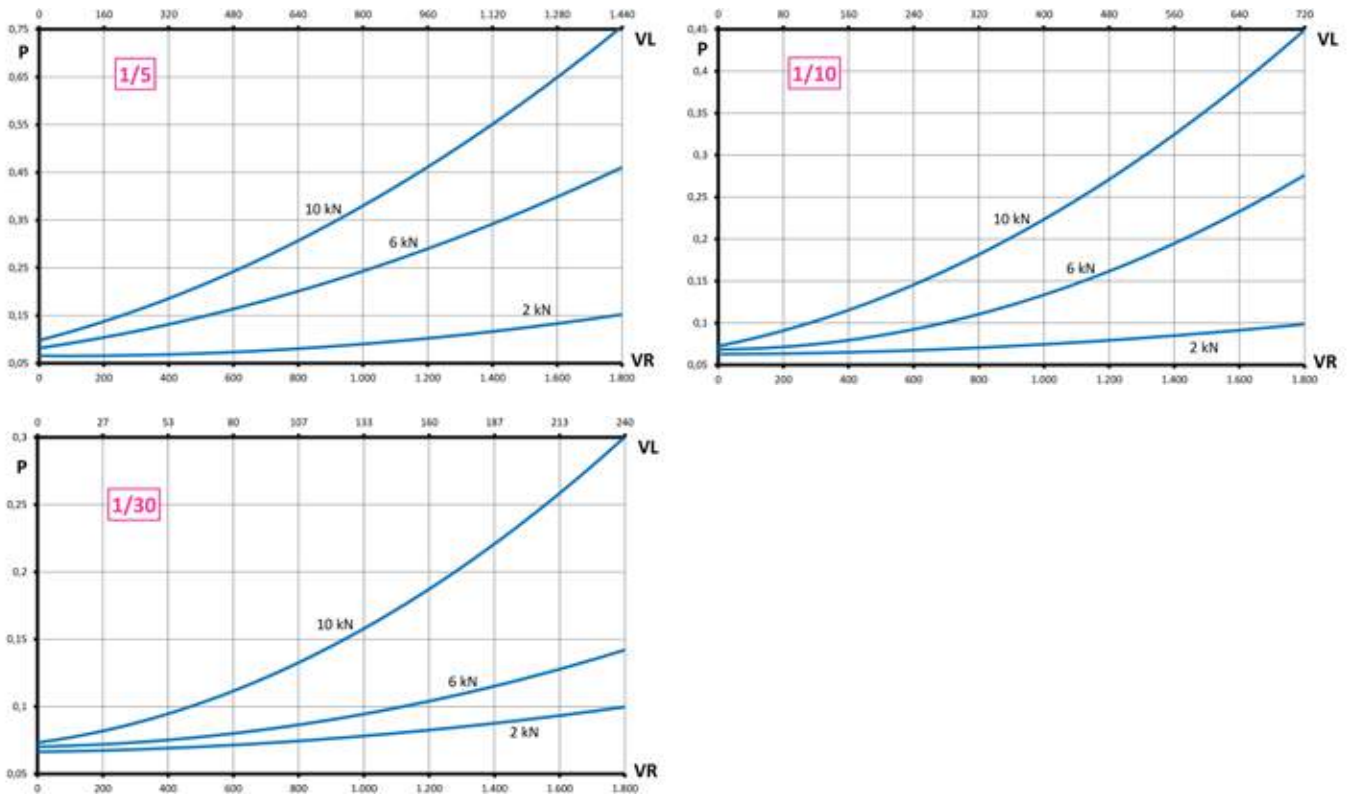
P = Requested input power [kW]



Motor Models

	IEC	Worm screw bore diameter	Centering diameter	Nominal power (4 poles motor)
	IEC 63 B5	11 mm	95 mm	0,25 kW
	IEC 71 B5 / 71 B14	14 mm	110 mm / 70 mm	0,55 kW
	IEC 80 B5 / 80 B14	19 mm	130 mm / 80 mm	1,1 kW

Construction Forms



Size 306 - 2,5 ton - 25 kN



XTP Model



XTPR Model

Materials

	Material	Norms	Specs	Indications
Worm	16NiCr4	EN 10084:2008	Casehardening alloy steel	Casehardened and ground on teeth and holds
Worm wheel	CuAl10Fe2-GM	EN 1982:2008	Aluminium bronze	Chill molded
Nut	CuAl10Fe2-GM	EN 1982:2008	Aluminium bronze	Chill molded
Spindle	X5 CrNiMo 17-12-2 (AISI 316)	EN 10088-1:2014	Stainless steel	Tr 30x6 (ISO 2901:2016) - Machined
Carter	X5 CrNiMo 17-12-2 (AISI 316)	EN 10088-1:2014	Stainless steel	Completely machined on 6 faces
Lubricant	Unimec Mark CA		Calcium based grease	0,1 kg

General features

Operating Temperature	-10 °C / 80 °C
Static Load (traction or compression)	40 kN
Dynamic Load (traction or compression)	25 kN
Max input speed	1800 rpm
Main Gearbox Weight	10 kg
Trapezoidal Screw Weight	5 kg/m
Anti-Rotation Torque with Max Load	63 Nm
Max admissible lateral loads	0 N
Center-to-center distance	50 mm
Max radial Load on worm Screw	450 N
Standard Working Conditions	25 °C - service 10%

Euler's law (safety factor =2; dynamic compression load)

Limit Load 1 (red) - 2 (blue) - 3 (green)

C = Load [kN]

L = Overall trapezoidal screw length [mm]

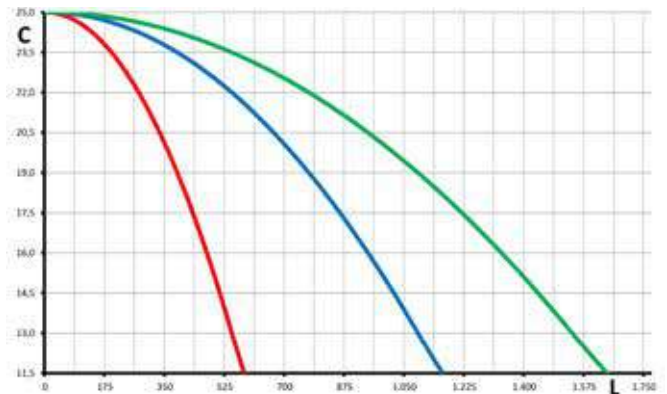

Specific features

	Nominal Ratios		
	1/5	1/10	1/30
Real ratio	1/4,75	1/9,67	1/30
Translation per worm revolution	1,26 mm	0,62 mm	0,2 mm
Efficiency	30 %	26 %	18 %
Start-up efficiency	21 %	18 %	13 %
Maximum linear speed	2160	1080	360
Torque at maximum load	16 Nm	9,3 Nm	4,4 Nm
Worm screw maximum torque	69 Nm	154 Nm	183 Nm
Loadless torque	0,4 Nm	0,3 Nm	0,25 Nm

Power curves

The magenta zone indicates a potential heating risk. Working cycles must be carefully analyzed.



VR = Worm rotational speed [rpm]

VL = Spindle translation speed [mm/min]

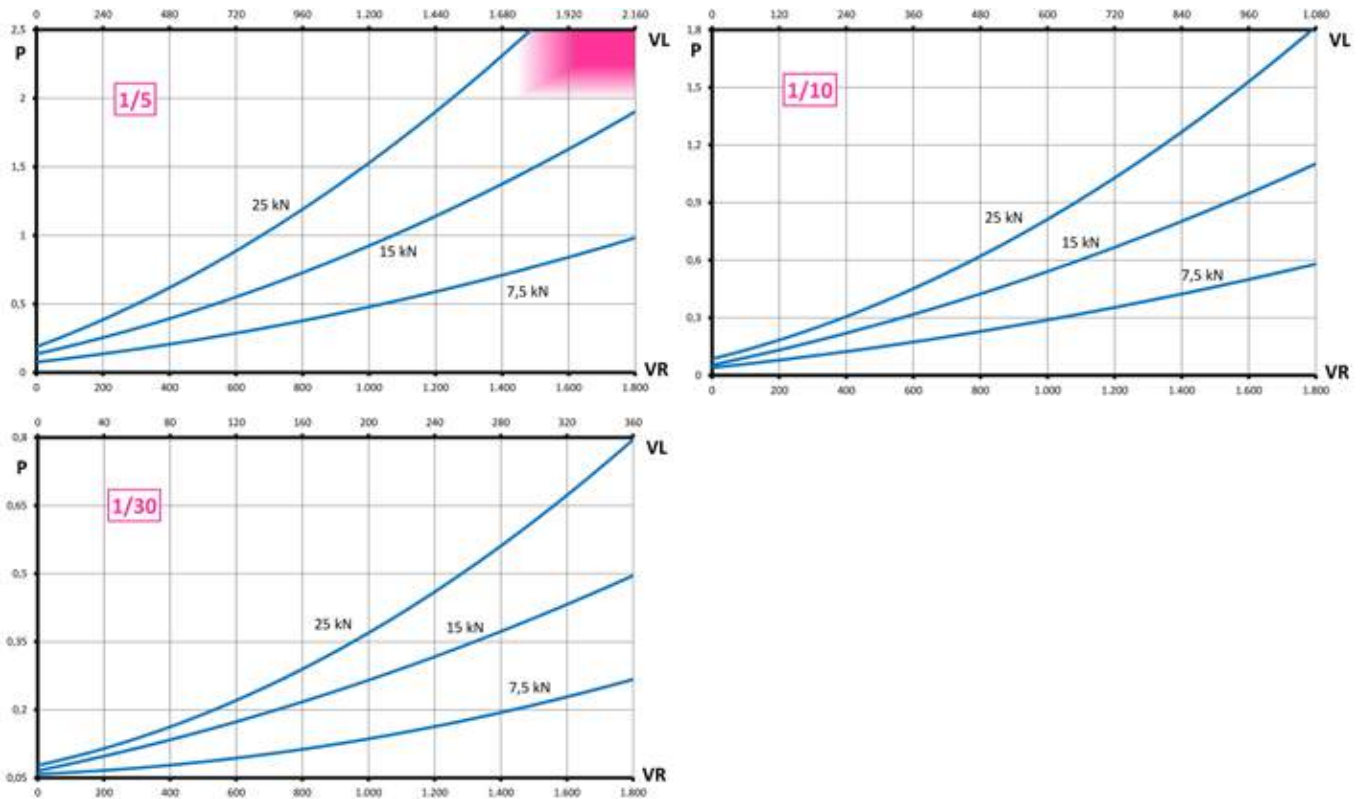
P = Requested input power [kW]



Motor Models

	IEC	Worm screw bore diameter	Centering diameter	Nominal power (4 poles motor)
	IEC 71 B5	11 mm	110 mm	0,55 kW
	IEC 80 B5 / B14	19 mm	130 mm / 80 mm	1,1 kW
	IEC 90 B5 / B14	24 mm	130 mm / 95 mm	1,9 kW
	IEC 100-112 B5 / B14	28 mm	180 mm / 110 mm	5 kW

Construction Forms



Size 407 - 5 ton - 50 kN



XTP Model



XTPR Model

Materials

	Material	Norms	Specs	Indications
Worm	16NiCr4	EN 10084:2008	Casehardening alloy steel	Casehardened and ground on teeth and holds
Worm wheel	CuAl10Fe2-GM	EN 1982:2008	Aluminium bronze	Chill molded
Nut	CuAl10Fe2-GM	EN 1982:2008	Aluminium bronze	Chill molded
Spindle	X5 CrNiMo 17-12-2 (AISI 316)	EN 10088-1:2014	Stainless steel	Tr 40x7 (ISO 2901:2016) - Machined
Carter	X5 CrNiMo 17-12-2 (AISI 316)	EN 10088-1:2014	Stainless steel	Completely machined on 6 faces
Lubricant	Unimec Mark CA		Calcium based grease	0,1 kg

General features

Operating Temperature	-10 °C / 80 °C
Static Load (traction or compression)	80 kN
Dynamic Load (traction or compression)	50 kN
Max input speed	1800 rpm
Main Gearbox Weight	18 kg
Trapezoidal Screw Weight	9 kg/m
Anti-Rotation Torque with Max Load	165 Nm
Max admissible lateral loads	300 N
Center-to-center distance	70 mm
Max radial Load on worm Screw	600 N
Standard Working Conditions	25 °C - service 10%

Euler's law (safety factor =2; dynamic compression load)
 Limit Load 1 (red) - 2 (blue) - 3 (green)
 C = Load [kN]
 L = Overall trapezoidal screw length [mm]

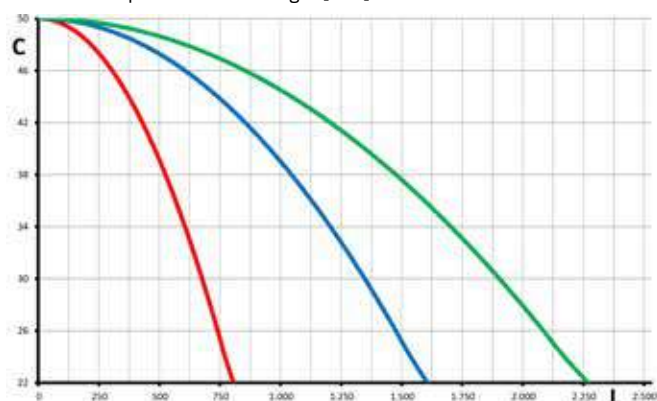

Specific features

	Nominal Ratios		
	1/5	1/10	1/30
Real ratio	1/5	1/10	1/30
Translation per worm revolution	1,4 mm	0,7 mm	0,23 mm
Efficiency	28 %	25 %	18 %
Start-up efficiency	20 %	18 %	13 %
Maximum linear speed	2520	1260	420
Torque at maximum load	40 Nm	23 Nm	11 Nm
Worm screw maximum torque	490 Nm	128 Nm	154 Nm
Loadless torque	0,65 Nm	0,45 Nm	0,35 Nm

Power curves

The magenta zone indicates a potential heating risk. Working cycles must be carefully analyzed.



VR = Worm rotational speed [rpm]

VL = Spindle translation speed [mm/min]

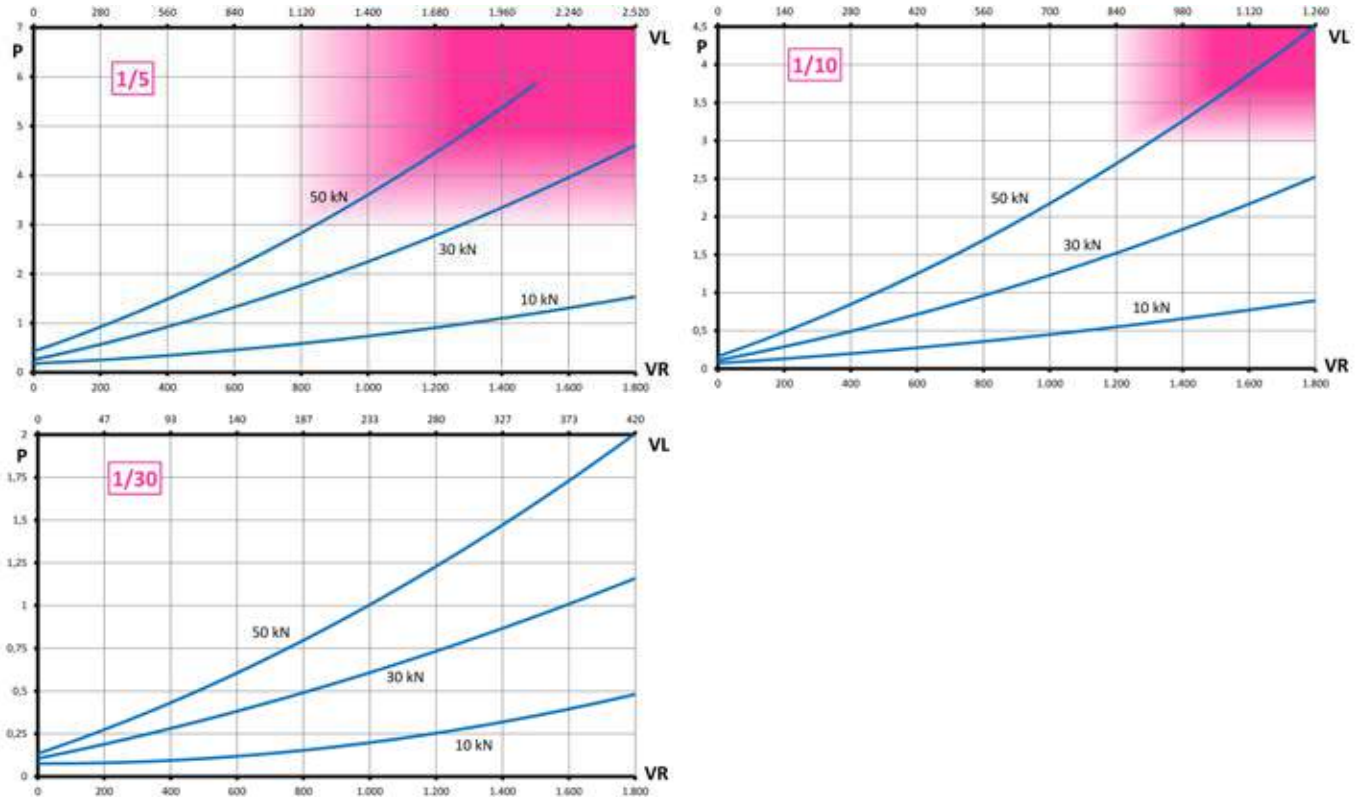
P = Requested input power [kW]



Motor Models

	IEC	Worm screw bore diameter	Centering diameter	Nominal power (4 poles motor)
	IEC 71 B5	11 mm	110 mm	0,55 kW
	IEC 80 B5 / B14	19 mm	130 mm / 80 mm	1,1 kW
	IEC 90 B5 / B14	24 mm	130 mm / 95 mm	1,9 kW
	IEC 100-112 B5 / B14	28 mm	180 mm / 110 mm	5 kW
	IEC 132 B5 / B14	38 mm	230 mm / 130 mm	9,2 kW

Construction Forms



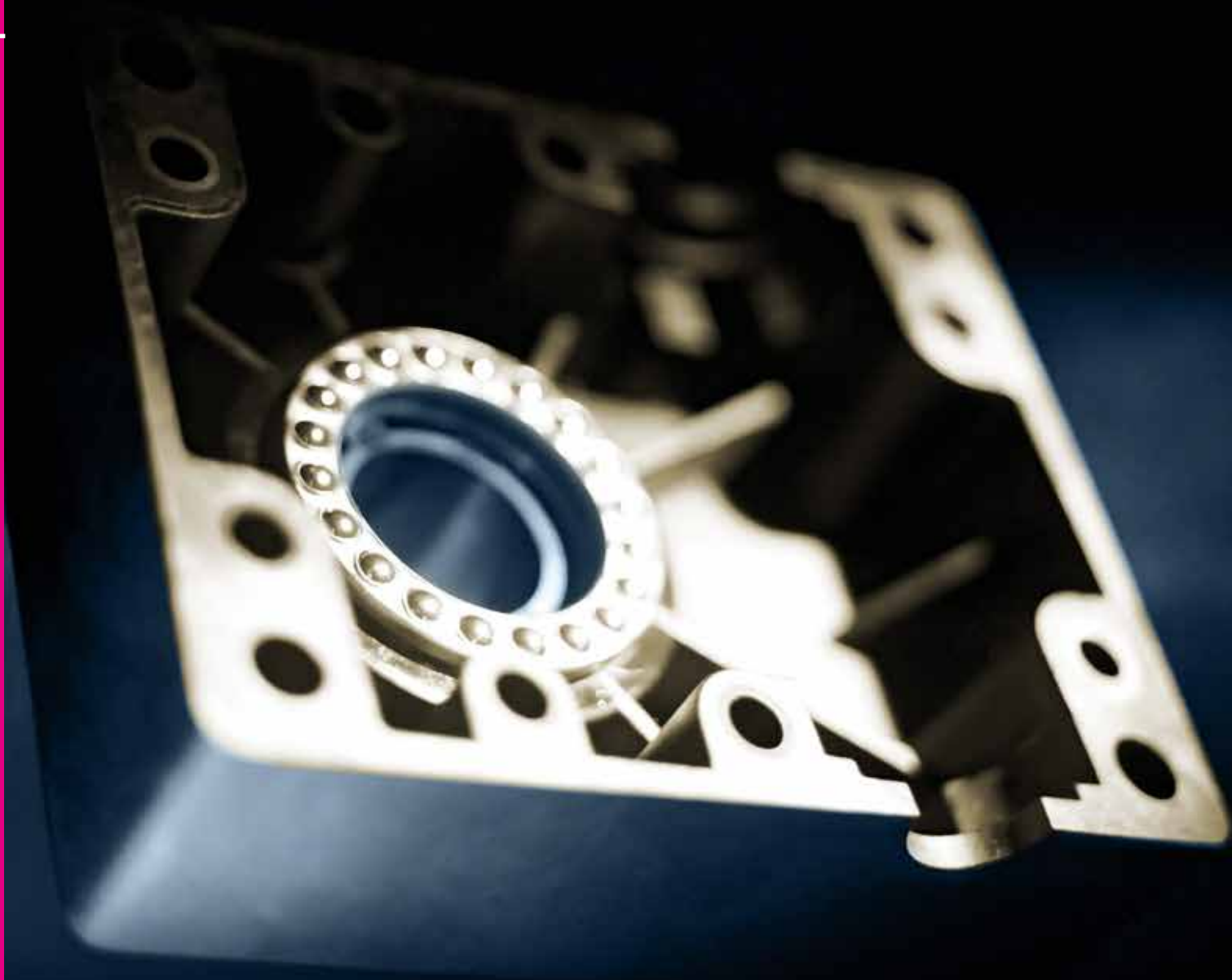

Technopolymer Screw Jacks



New market demands, the growth of light applications and a spirit of innovation and research have pushed UNIMEC to realize a new trapezoidal screw jack series with an high price-quality ratio: the Aleph series.

This new line includes two sizes and its peculiarity is that some components are made of a techno-polymer having very high mechanical features.

Having a structure quite similar to full metal screw jacks, Aleph series screw jacks have the same load handling functions and they also maintain the same irreversibility features.

The particular molding system of the gears and the peculiarity of the polyarilammide material employed, allow it to operate even without lubrication.

Aleph screw jacks can work singularly or in groups connected by means of joints, shafts and bevel gearboxes.

Handling

MOTORIZED OPERATION

Aleph series can be handled by any kind of motors. Nowadays it's possible a direct motorization for some IEC flanges thanks to an innovative molding process able to shroud bolts in the carter. It's possible to connect 4, 6 or 8 poles motors, while it's not suggested to assemble 2 poles motors for not overpass 1500/1800 rpm input rotational speed. Power curves show, in case of unitary service factors and for single jack unit, the input power in function of the size, ratio, dynamic load and linear speed.

MANUAL OPERATION

The Aleph series can be manually operated.

ROTATION DIRECTIONS

The rotation directions and the respective linear movements are showed in the drawings below. In standard conditions, UNIMEC supplies screw jacks equipped with right-handed worm screw, to which the movements illustrated in drawings 1 and 2 correspond. Upon request it is possible to have a left-handed worm screw, to which the movements illustrated in drawings 3 and 4 correspond. The combinations between threaded spindles and left-handed or right-handed worm screw, lead to the four combinations listed in the table below.

Worm screw	RH	LH
Threaded spindle	RH	RH
Direct motorization on the worm screw	Possible	Impossible
Handling	1-2	3-4



1



2



3



4

Lubrication

Thanks to particular solutions during the molding process, a film of pure polymer is formed on the molded components surfaces, which has high sliding properties. This factor, in synergy with light services, enables the Aleph series to work in absence of lubricant. Anyway the presence of a lubricant layer on the threaded spindle

can extend the screw jacks life; for the lubricants choice make reference to what has been indicated in the correspondent paragraph in the screw jacks section (page 17). It should be reminded that the Aleph series does not foresee any oil plug.

Installation and maintenance

INSTALLATION

The screw jack must be installed in such a manner as not to create lateral loads on the threaded spindle. Great care must be taken to ensure that the threaded spindle is orthogonal to the mounting plane, and that the load and threaded spindle are on the same axis. Employing multiple screw jacks to handle the same load requires further verifications: it is critical that the load support points, (the end fittings for TP models and the lead nuts for TPR models), be perfectly aligned in order that the load can be uniformly distributed; otherwise the misaligned screw jacks would act as brake or counter-load. Whenever several jacks have to be connected by means of transmission shafts, it is recommended that they be perfectly aligned in order to avoid overloading on the worm screws. It is advisable to use joints capable of absorbing alignment errors but having at the same time a rigid torsion necessary to keep the synchronization of the transmission. The assembly or disassembly of the joints or pulleys of worm screw must be carried out by means of tie rods or extractors, using, if necessary, the threaded hole on top of the worm screw; striking or hammering could damage the inner bearings. For heat-shrinking joints or pulleys, we recommend a temperature between 80-100 °C. Installations environments with dust, water, vapors, etc. require precautions systems to protect the threaded spindle. This can be done by using elastic protections or rigid protections. The above protections are also used in order to avoid any accidental human contact with the moving devices.

START-UP

All Aleph screw jacks undergo a careful quality examination before being delivered to the client, and are dynamically tested load-free. When starting-up a machine where screw jacks are installed, it is critical to check for the lubrication of the threaded spindles (whether foreseen and if possible) and for the absence of foreign material. During the calibration of the electrical end-of-stroke systems, the inertia of the moving masses should be considered, which for vertical loads will be lower in ascent and greater in descent. It is advisable to start the machine with the minimum possible load and to make sure all components are working properly, before assuming regular operation. Especially at start-up, it is critical to follow the instructions given in the manual: continuous or hazardous testing maneuvers could lead to an abnormal overheating and cause irreparable damages. One only temperature peak is enough to cause premature wear or breakdown of the aleph screw jack.

ROUTINE MAINTENANCE

Screw jacks must be periodically inspected, depending on the use and working environment.

STORAGE

The screw jacks must be protected from deposits of dust and foreign matter during storage. Particular attention must be paid to saline or corrosive atmospheres. We recommend to store Aleph screw jacks in a closed place, in order to avoid an excessive water absorption of the polymer. We also recommend to:

- Lubricate and protect the threaded spindle, the worm screw and the non varnished components
- Support the threaded spindle in case of horizontal storage.

WARRANTY

The warranty is valid only when the instructions contained in our manual are carefully followed.



TP Model

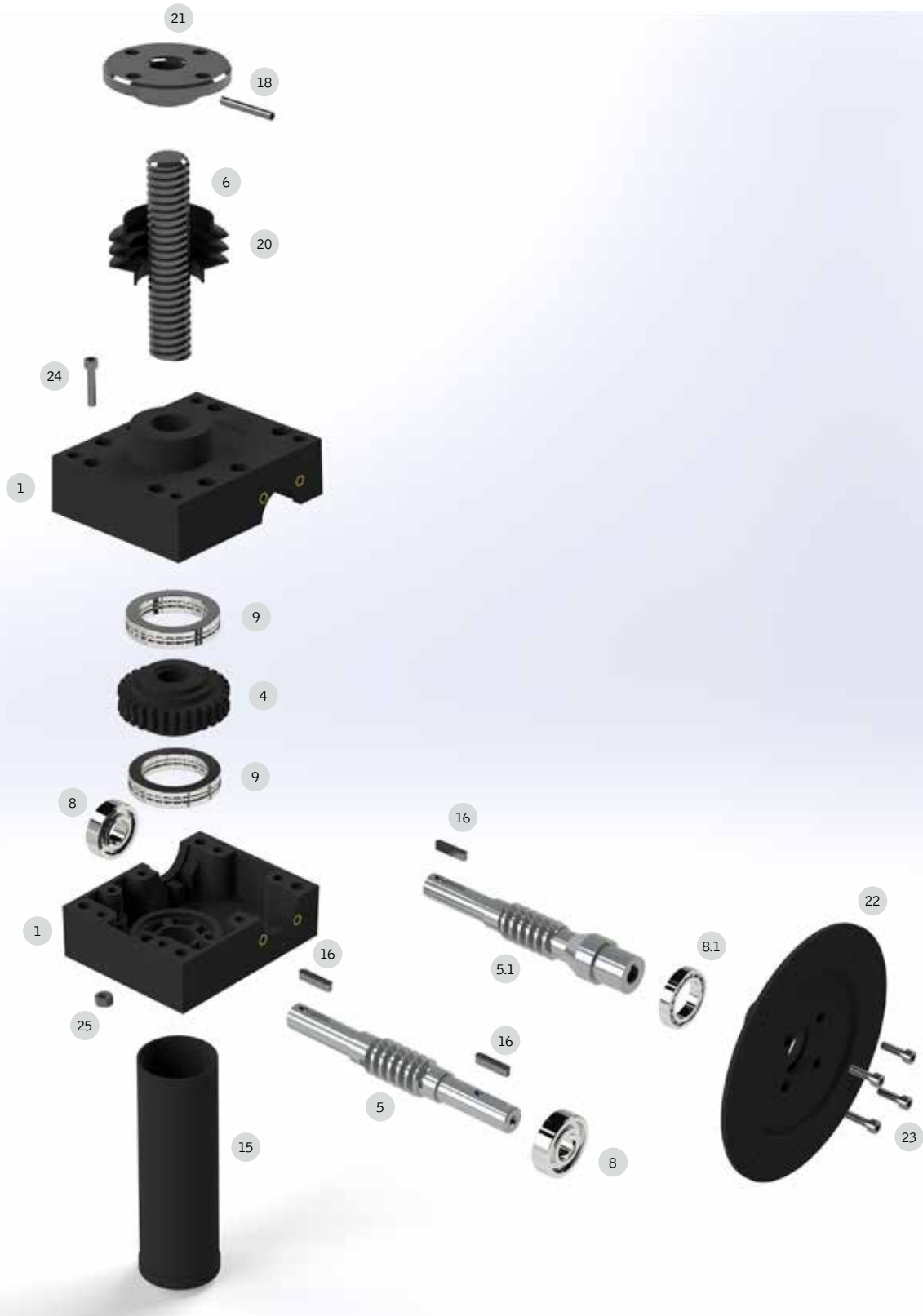

1 Casing (half-shell)	8 Worm screw bearing	18 End fitting elastic fastening pin	24 Bolt
4 Worm wheel	8.1 Motor worm screw bearing	20 Elastic protection	25 Nut
5 Worm screw	9 Worm wheel bearing	21 End fitting	
5.1 Motor worm screw	15 Rigid protection	22 Motor flange	
6 Threaded spindle	16 Key	23 Screw	

TPR Model

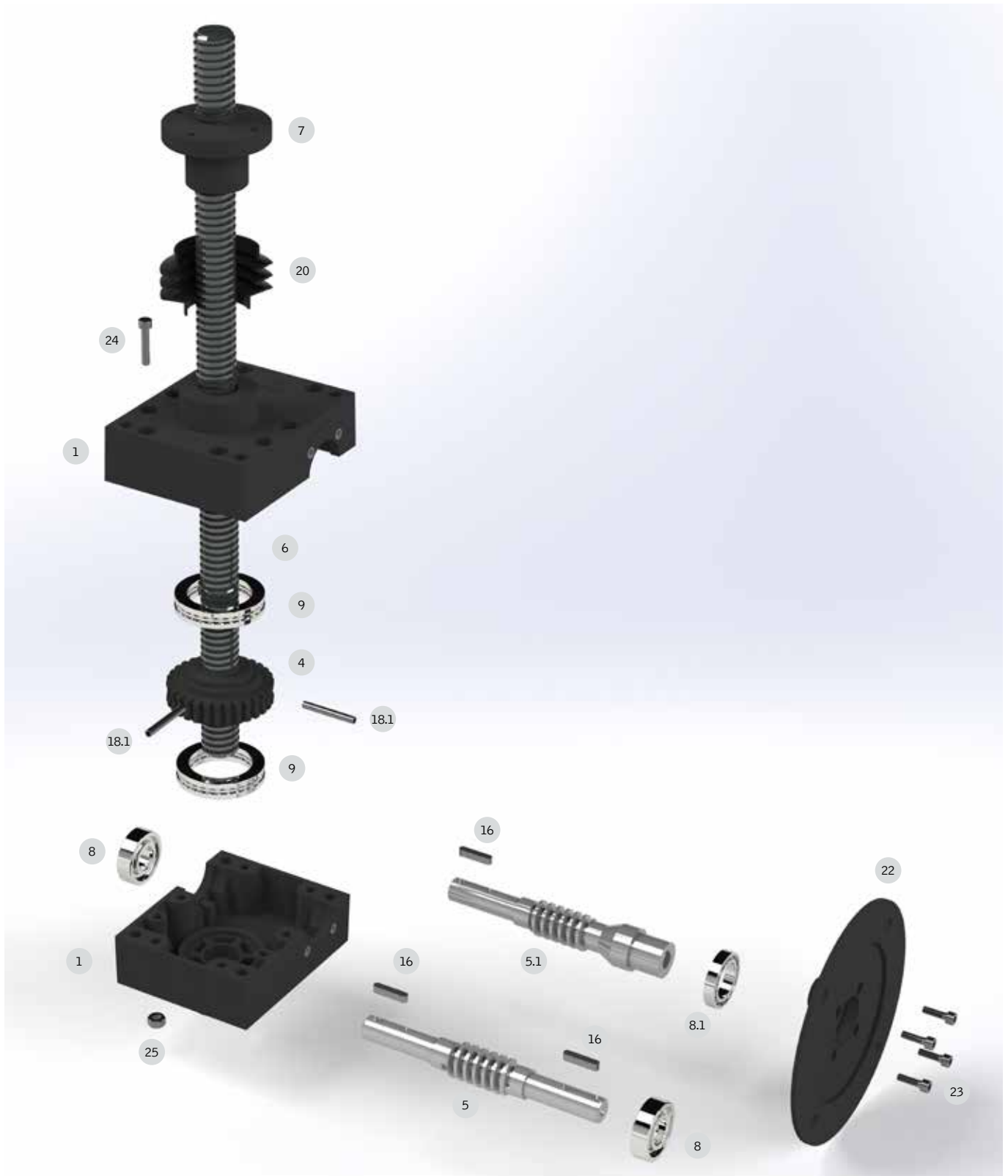

1 Casing (half-shell)	6 Threaded spindle	9 Worm wheel bearing	22 Motor flange
4 Worm wheel	7 Lead nut	16 Key	23 Screw
5 Worm screw	8 Worm screw bearing	18.1 Worm wheel elastic fastening pin	24 Bolt
5.1 Motor worm screw	8.1 Motor worm screw bearing	20 Elastic protection	25 Nut

Size 420 - 0,7 ton - 7 kN



TP Model

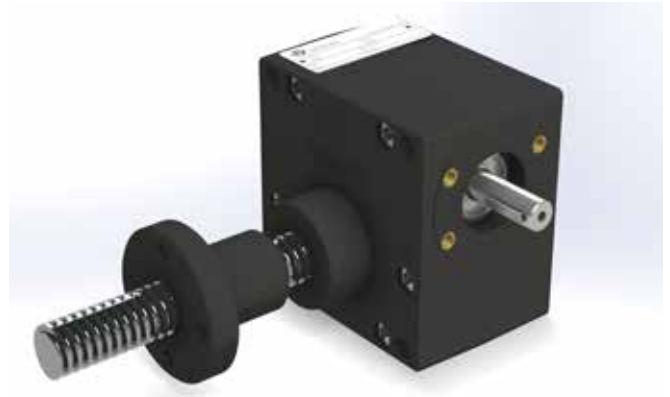

TPR Model

Materials

	Material	Norms	Specs	Indications
Worm	16NiCr4	EN 10084:2008	Casehardening alloy steel	Casehardened and ground on teeth and holds
Spindle	C45	EN 10083-2:2006	Carbon steel	Tr 20x4 (ISO 2901:2016) - Rolled or machined
Carter	Technopolymer		Polyarylamide	Made by 2 half-shell
Nut	Technopolymer		Polyarylamide	Glass fiber reinforced
Worm wheel	Technopolymer		Polyarylamide	Glass fiber reinforced

General features

Operating Temperature	-20 °C / 50 °C
Static Load (traction or compression)	12 kN
Dynamic Load (traction or compression)	7 kN
Max input speed	1800 rpm
Main Gearbox Weight	1 kg
Trapezoidal Screw Weight	2,22 kg/m
Anti-Rotation Torque with Max Load	17 Nm
Max admissible lateral loads	0 N
Center-to-center distance	30 mm
Max radial Load on worm Screw	220 N
Standard Working Conditions	25 °C - service 10%

Euler's law (safety factor =2; dynamic compression load)
 Limit Load 1 (red) - 2 (blue) - 3 (green)
 C = Load [kN]
 L = Overall trapezoidal screw length [mm]

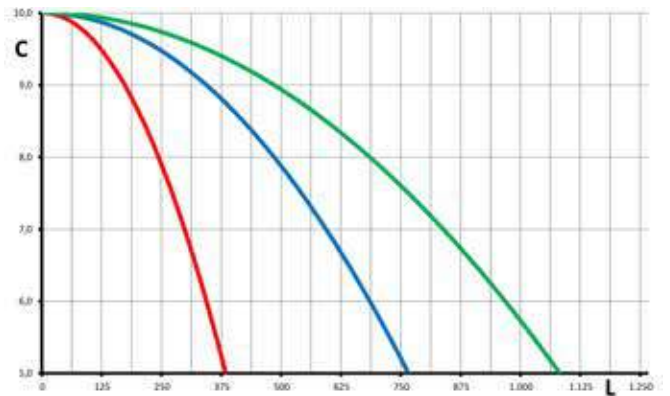

Specific features

	Nominal Ratios		
	1/5	1/10	1/30
Real ratio	1/4,75	1/10,5	1/30
Translation per worm revolution	0,842 mm	0,38 mm	0,13 mm
Efficiency	31 %	28 %	20 %
Start-up efficiency	22 %	19 %	14 %
Maximum linear speed	1440	720	240
Torque at maximum load	4,2 Nm	2,3 Nm	1,1 Nm
Worm screw maximum torque	54 Nm	54 Nm	42 Nm
Loadless torque	0,25 Nm	0,2 Nm	0,15 Nm

Power curves

The magenta zone indicates a potential heating risk. Working cycles must be carefully analyzed.

VR = Worm rotational speed [rpm]

VL = Spindle translation speed [mm/min]

P = Requested input power [kW]

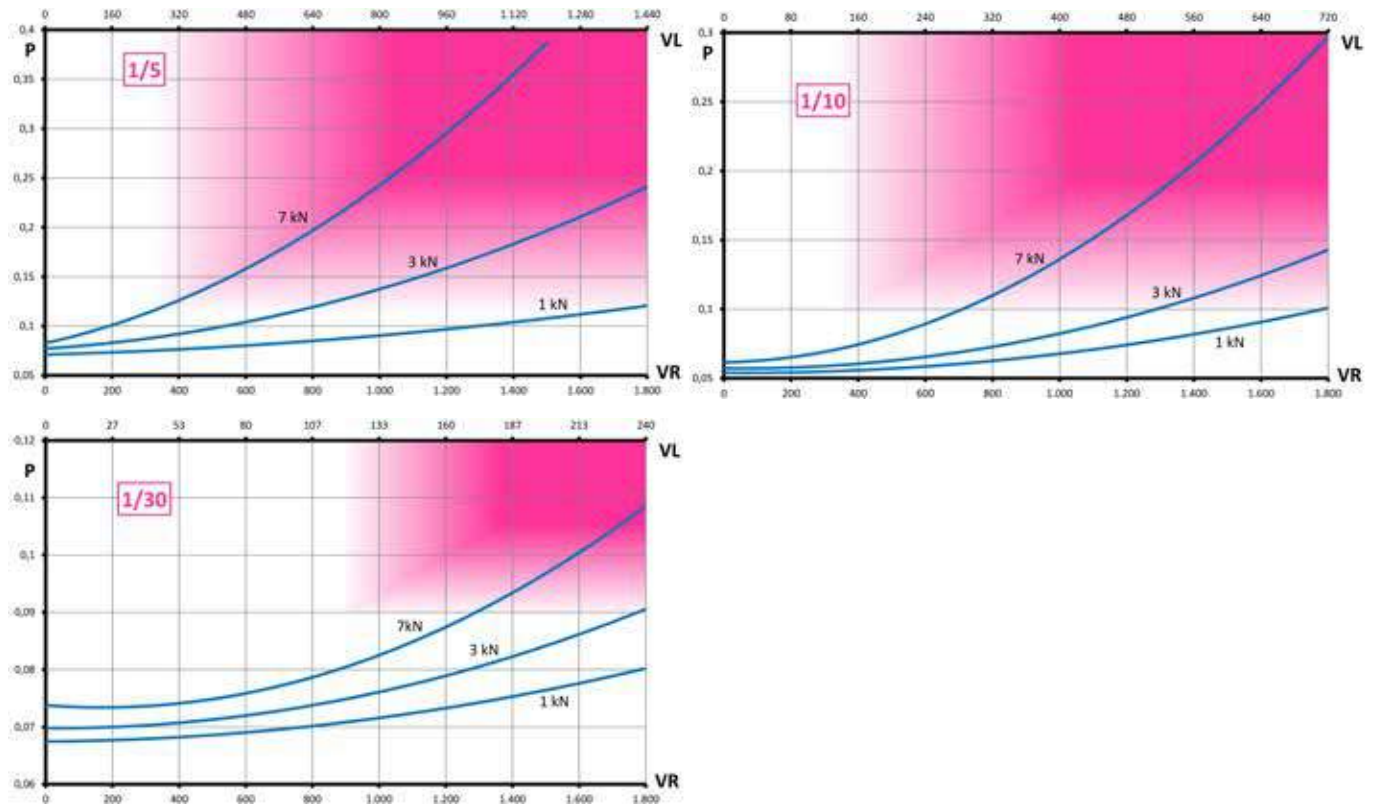

Motor Models

	IEC	Worm screw bore diameter	Centering diameter	Nominal power (4 poles motor)
	IEC 63 B5	11 mm	95 mm	0,25 kW

Construction Forms



Size 630 - 1 ton - 10 kN



TP Model



TPR Model

Materials

	Material	Norms	Specs	Indications
Worm	16NiCr4	EN 10084:2008	Casehardening alloy steel	Casehardened and ground on teeth and holds
Spindle	C45	EN 10083-2:2006	Carbon steel	Tr 30x6 (ISO 2901:2016) - Rolled or machined
Carter	Technopolymer		Polyarylamide	Made by 2 half-shell
Nut	Technopolymer		Polyarylamide	Glass fiber reinforced
Worm wheel	Technopolymer		Polyarylamide	Glass fiber reinforced

General features

Operating Temperature	-20 °C / 50 °C
Static Load (traction or compression)	18 kN
Dynamic Load (traction or compression)	10 kN
Max input speed	1800 rpm
Main Gearbox Weight	2,7 kg
Trapezoidal Screw Weight	5 kg/m
Anti-Rotation Torque with Max Load	63 Nm
Max admissible lateral loads	0 N
Center-to-center distance	50 mm
Max radial Load on worm Screw	450 N
Standard Working Conditions	25 °C - service 10%

Euler's law (safety factor =2; dynamic compression load)

Limit Load 1 (red) - 2 (blue) - 3 (green)

C = Load [kN]

L = Overall trapezoidal screw length [mm]

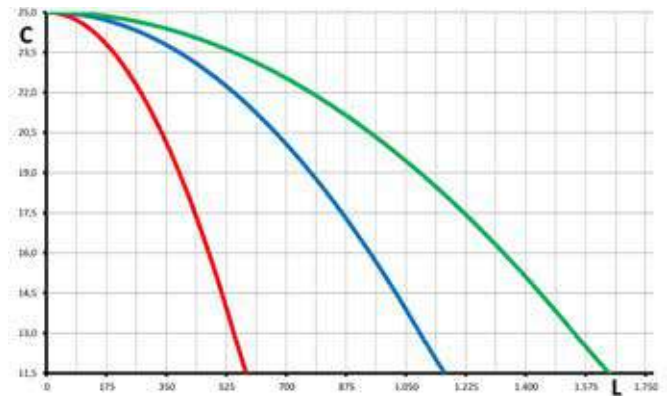

Specific features

	Nominal Ratios		
	1/5	1/10	1/30
Real ratio	1/4,75	1/9,67	1/30
Translation per worm revolution	1,26 mm	0,62 mm	0,2 mm
Efficiency	30 %	26 %	18 %
Start-up efficiency	21 %	18 %	13 %
Maximum linear speed	2160	1080	360
Torque at maximum load	16 Nm	9,3 Nm	4,4 Nm
Worm screw maximum torque	69 Nm	154 Nm	183 Nm
Loadless torque	0,4 Nm	0,3 Nm	0,25 Nm

Power curves

The magenta zone indicates a potential heating risk. Working cycles must be carefully analyzed.

VR = Worm rotational speed [rpm]

VL = Spindle translation speed [mm/min]

P = Requested input power [kW]

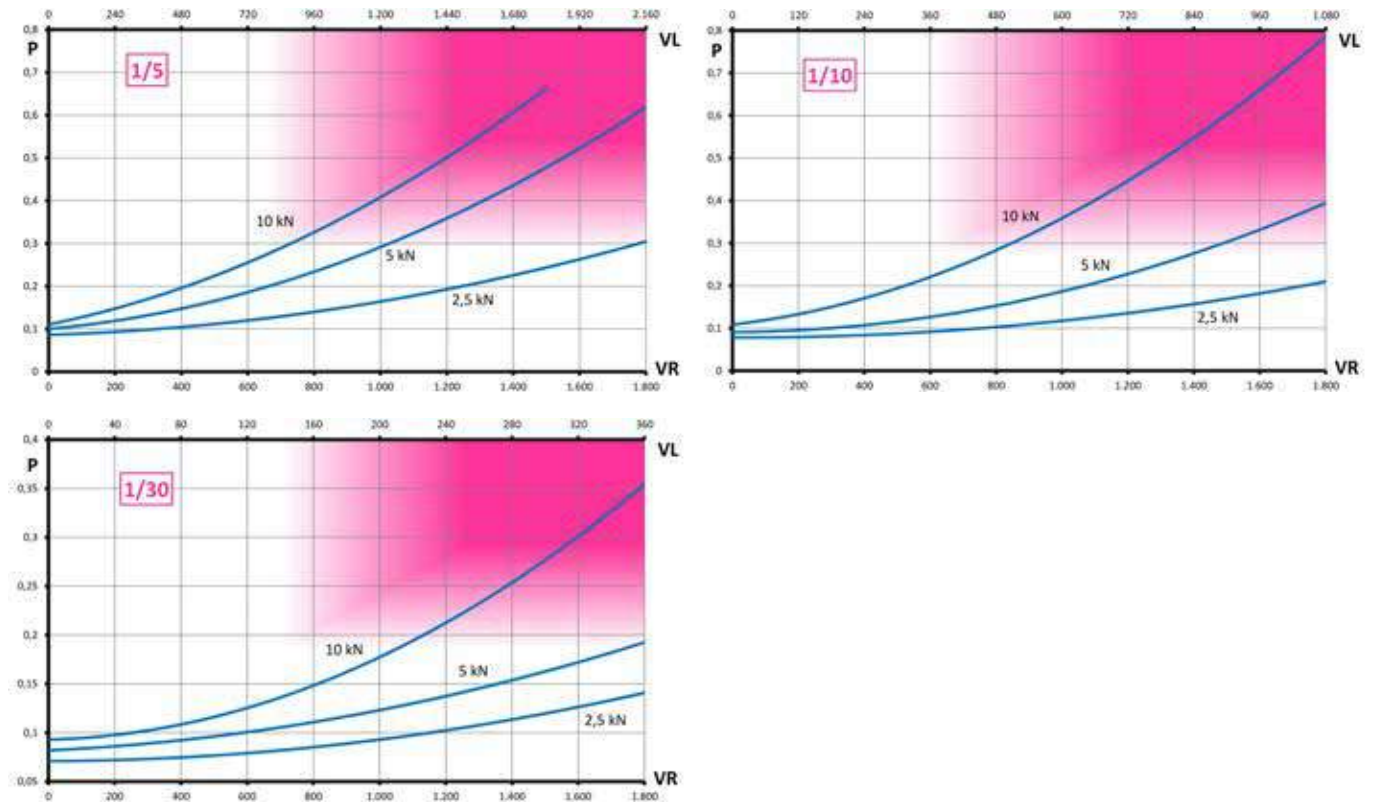

Motor Models

	IEC	Worm screw bore diameter	Centering diameter	Nominal power (4 poles motor)
	IEC 71 B5	11 mm	110 mm	0,55 kW

Construction Forms



Size 740 - 1,8 ton - 18 kN



TP Model



TPR Model

Materials

	Material	Norms	Specs	Indications
Worm	16NiCr4	EN 10084:2008	Casehardening alloy steel	Casehardened and ground on teeth and holds
Spindle	C45	EN 10083-2:2006	Carbon steel	Tr 40x7 (ISO 2901:2016) - Rolled or machined
Carter	Technopolymer		Polyarylamide	Made by 2 half-shell
Nut	Technopolymer		Polyarylamide	Glass fiber reinforced
Worm wheel	Technopolymer		Polyarylamide	Glass fiber reinforced

General features

Operating Temperature	-20 °C / 50 °C
Static Load (traction or compression)	30 kN
Dynamic Load (traction or compression)	18 kN
Max input speed	1800 rpm
Main Gearbox Weight	3 kg
Trapezoidal Screw Weight	9 kg/m
Anti-Rotation Torque with Max Load	165 Nm
Max admissible lateral loads	300 N
Center-to-center distance	70 mm
Max radial Load on worm Screw	600 N
Standard Working Conditions	25 °C - service 10%

Euler's law (safety factor =2; dynamic compression load)

Limit Load 1 (red) - 2 (blue) - 3 (green)

C = Load [kN]

L = Overall trapezoidal screw length [mm]

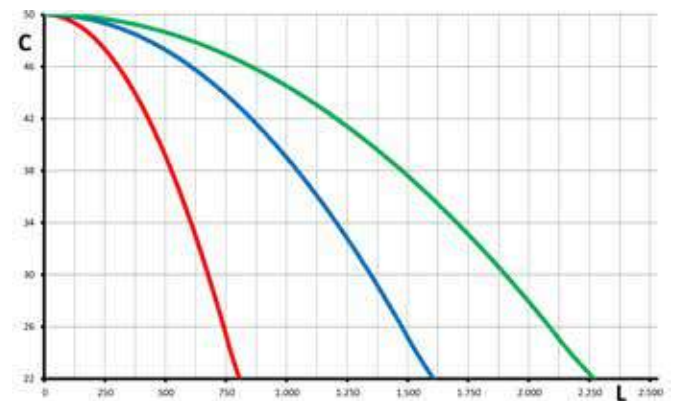

Specific features

	Nominal Ratios		
	1/5	1/10	1/30
Real ratio	1/5	1/10	1/30
Translation per worm revolution	1,4 mm	0,7 mm	0,23 mm
Efficiency	28 %	25 %	18 %
Start-up efficiency	20 %	18 %	13 %
Maximum linear speed	2520	1260	420
Torque at maximum load	40 Nm	23 Nm	11 Nm
Worm screw maximum torque	490 Nm	128 Nm	154 Nm
Loadless torque	0,65 Nm	0,45 Nm	0,35 Nm



Power curves

The magenta zone indicates a potential heating risk. Working cycles must be carefully analyzed.

VR = Worm rotational speed [rpm]

VL = Spindle translation speed [mm/min]

P = Requested input power [kW]

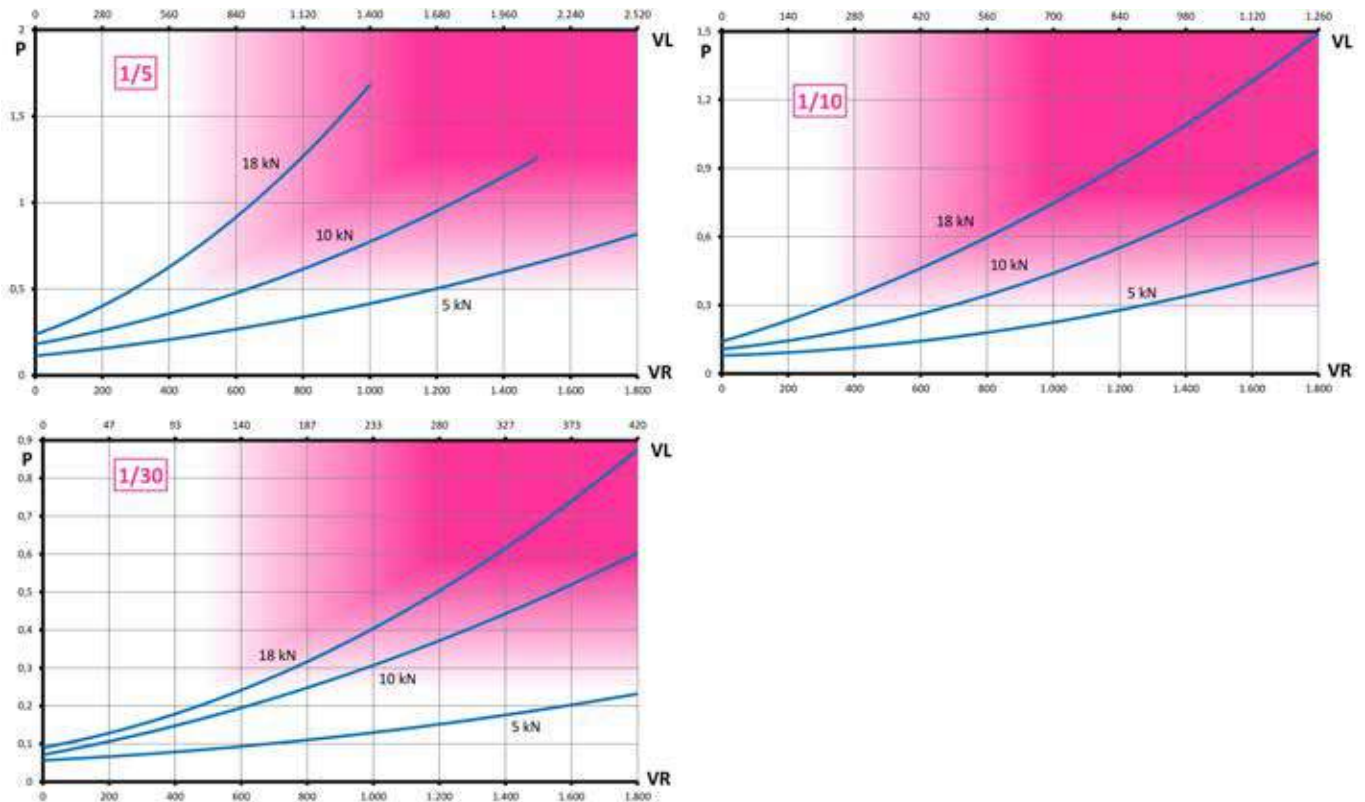

Motor Models

	IEC	Worm screw bore diameter	Centering diameter	Nominal power (4 poles motor)
	IEC 80 B5	19 mm	130 mm / 80 mm	1,1 kW

Construction Forms



AB Worm Screw Protection Ring



> Specifications



The AB Worm Screw Protection Ring is a metal ring protecting the seal of the worm screw. It also serves as a support surface for mechanical couplings protecting the transmission from friction and accidental collisions.

AM-TP Over-Size Trapezoidal Screw



> Specifications



The AM-TP Over-Size Trapezoidal Screw is a simple and effective option used in cases where the static load is significantly higher than the dynamic load; the AM-TP Over-Size Trapezoidal Screw uses the next-size-up trapezoidal screw, thus adding a significant extra safety factor. The increased surface of the thread makes this option ideal with high loads at lower speeds.

Please note that while the Euler's Law compression static load verification may be calculated according to the next-size-up screw jack, all other dynamic parameters must be referenced to the actual size of the Screw Jack.

AM-TPR Over-Size Trapezoidal Screw



> Specifications



The AM-TPR Over-Size Trapezoidal Screw is a simple and effective option used in cases where the static load is significantly higher than the dynamic load; the AM-TPR Over-Size Trapezoidal Screw uses the next-size-up trapezoidal screw and nut and thus adding a significant extra safety factor. The increased surface of the thread makes this option ideal with high loads at lower speeds.

Please note that while the Euler's Law compression static load verification may be calculated according to the next-size-up screw jack, all other dynamic parameters must be referenced to the actual size of the Screw Jack.

AR Anti-Rotation System



> Specifications



The AR Anti-Rotation system consists of a full-length channel milled into the translating trapezoidal screw and a special collar with a key mounted on the cover of the Screw Jack: the fixed key slides along the channel, preventing the trapezoidal screw from rotating. Please keep in mind that the milled channel causes a mechanical weakening of the trapezoidal screw resulting in a 40% reduction of the dynamic load capacity and a 13% reduction of the

static load capacity. Additionally, because of the milled channel, it is recommended to use the AR Anti-Rotation system only when the F_a factor is < 1 . Finally, because the AR Anti-Rotation system locks the screw and the end-fitting in a specific position, it is always necessary to specify the exact position of special holes or asymmetrical/non-centered details in the trapezoidal screw.

BU Anti-Disengagement Bushing



> Specifications



The BU Anti-Disengagement Bushing is a safety device preventing the translating trapezoidal screw from disengaging from the Screw Jack in the event of an accidental overstroke. The BU Anti-Disengagement Bushing features a trapezoidal thread which guarantees the full load support during the attempted overstroke. The BU Anti-Disengagement Bushing can only be installed in Screw

Jacks in the TP Series. If the PRF Stroke Control accessory is also installed on the Screw Jack, the BU Anti-Disengagement Bushing will work as an additional end-stroke safety device. Please keep in mind that even a single overstroke accident (with consequent impact of the BU Anti-Disengagement Bushing with the main body of the unit) can irreparably damage the internal gearing.

CAPP Worm Screw Protection Cover



> Specifications



The CAPP Worm Screw Protection Cover is a rigid plastic protection that covers one of the worm screw extremities protecting it from accidental collisions, dust and debris. It also works as a safety

device protecting live operators from moving parts. The CAPP Worm Screw Protection Cover can only be installed on Screw Jacks in the B Construction Form.

CHA Self-Aligning Nut



> Specifications

The CHA Self-Aligning Nut is an ingenious solution to potential problems determined by lateral loads. Specifically designed for the TPR Series, the CHA Self-Aligning Nut is based on a spherical nut embedded in two semi-shells made of strong and durable fiberglass-reinforced polymer adequately sized to support the load. Thanks to a special connection between the spherical nut and the polymer shells, the system is capable of compensating planar misalignments up to +/- 10°.

The system guarantees perfect axial coplanarity between screw and nut and eliminates overloads, stress, excessive friction and wear determined by lateral loads. The CHA Self-Aligning Nut is the ideal solution for large structures where the system is guided by framing beams and not by precision linear bearings.

CR Rotation Control Device

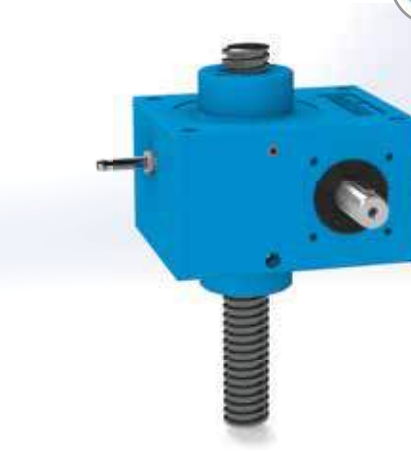
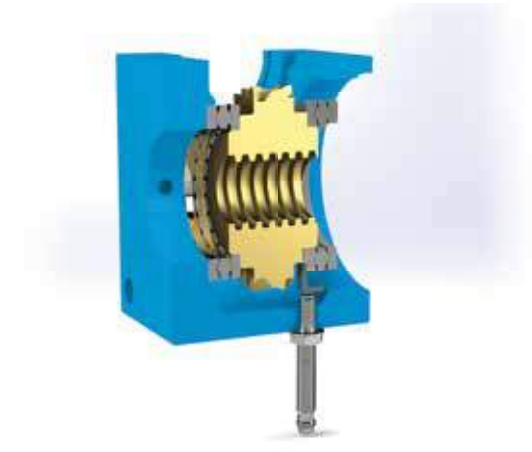

> Specifications

The CR Rotation Control Device, available on both the TP and TPR Series, is a rotation monitoring system based on a proximity transmitter sending an impulse at each revolution of the worm wheel.

The absence of signal indicates that the worm wheel is not rotating. Special configurations with multiple impulses per revolution are available upon request.

CS-TP Manual Wear Control Safety Nut



› Specifications



The CS-TP Safety Nut is a safety system allowing the Screw Jack to support the load even when, due to friction, the worm wheel begins to wear. The CS-TP Safety Nut is installed adjacent to the worm wheel and does not actively participate in supporting the payload until the worm wheel begins to wear. Once the worm wheel begins to wear, the play between the trapezoidal screw and worm wheel will naturally begin to increase; when a load is applied in these conditions, the CS-TP Safety Nut becomes engaged and begins to progressively support the load. Once engaged, the visible

protruding part of the CS-TP Safety Nut decreases and will continue to shorten with use; once this visible protruding part reaches the critical minimum height of 17 mm, it is necessary to replace both the worm wheel and the CS-TP Safety Nut. Failure to do so may cause irreparable damage to the main unit and catastrophic failure. The CS-TP Safety Nut can only work in a single direction (compression or traction); standard configuration is "compression"; please always specify load direction.

CS-TPR Manual Wear Control Safety Nut



› Specifications



The CS-TPR Safety Nut is a safety system allowing the Screw Jack to support the load even when, due to friction, the main nut begins to wear. The CS-TPR Safety Nut is installed adjacent to the main nut and does not actively participate in supporting the payload until the nut begins to wear. Once the main nut begins to wear, the play between the trapezoidal screw and nut will naturally begin to increase; when a load is applied in these conditions, the CS-TPR Safety Nut becomes engaged and begins to progressively support

the load. Once engaged, the distance between the main nut and the CS-TPR Safety Nut decreases and will continue to shorten with use; once this distance reaches the critical minimum value of 2 mm, it is necessary to replace both the main nut and the CS-TPR Safety Nut. Failure to do so may cause irreparable damage to the main unit and catastrophic failure. The CS-TPR Safety Nut can only work in a single direction (compression or traction); standard configuration is "compression"; please always specify load direction.

CSU-TP Automatic Wear Control Safety Nut



> Specifications



The CSU-TP Safety Nut with Automatic Wear Control is the automatic version of the manual CS-TP Safety Nut. The CSU-TP Safety Nut is installed adjacent to the worm wheel and does not actively participate in supporting the payload until the worm wheel begins to wear. Once the worm wheel begins to wear, the play between the trapezoidal screw and worm wheel will naturally begin to increase; when a load is applied in these conditions, the CS-TP Safety Nut becomes engaged and begins to progressively support the load. Differently from the manual version, with the CSU-TP Automatic Wear Control Safety Nut the protruding part

of the nut is covered by a lid and not visible to the operator; a proximity switch monitors the gap and alerts when the distance reaches the critical minimum height (approximately 1/4 of the nominal lead of the trapezoidal screw). Once the critical distance is reached it is necessary to replace both the worm wheel and the CS-TP Safety Nut. Failure to do so may cause irreparable damage to the main unit and catastrophic failure. The CS-TP Safety Nut can only work in a single direction (compression or traction); standard configuration is "compression"; please always specify load direction.

CSU-TPR Automatic Wear Control Safety Nut



> Specifications



The CSU-TPR Safety Nut with Automatic Wear Control is the automatic version of the manual CS-TPR Safety Nut. The CSU-TPR Safety Nut is installed adjacent to the main nut and does not actively participate in supporting the payload until the nut begins to wear. Once the nut begins to wear, the play between the trapezoidal screw and the nut will naturally begin to increase; when a load is applied in these conditions, the CS-TPR Safety Nut becomes engaged and begins to progressively support the load. In the CSU-TPR Automatic Wear Control Safety Nut the protruding

part of the nut is both visible to the operator and monitored by a proximity switch constantly measuring the gap. Once the critical distance (approximately 1/4 of the nominal lead of the trapezoidal screw) is reached the proximity switch will alert the operator that it is time to replace both the main nut and the CS-TPR Safety Nut. Failure to do so may cause irreparable damage to the main unit and catastrophic failure. The CS-TPR Safety Nut can only work in a single direction (compression or traction); standard configuration is "compression"; please always specify load direction.

CT Temperature Control



> Specifications



The CT Temperature Control option is based on a temperature measuring probe, installed directly on the body of the unit and capable of measuring temperature variations between -40°C (-40°F) and 90°C (194°F). Being irreversible power transmissions, screw jacks tend to dissipate a significant amount of input power in the form of heat; the CT Temperature Control

is recommended in all those applications where temperature monitoring is a critical factor. It is recommended to never exceed the upper limit of 80°C (176°F); when the system reaches this critical limit, it is necessary to stop the transmission and wait until the system returns to room temperature. Failure to do so may cause premature wear and/or catastrophic failure.

CTC Nut Temperature Control



> Specifications



The CTC Nut Temperature Control option, specifically designed for the TPR Series, is based on a temperature measuring probe, installed directly on the nut of the Screw Jack and capable of measuring temperature variations between -40°C (-40°F) and 90°C (194°F).

Being irreversible power transmissions, screw jacks tend to dissipate a significant amount of input power in the form of heat;

the CTC Nut Temperature Control is recommended in all those applications where temperature monitoring is a critical factor. It is recommended to never exceed the upper limit of 80°C (176°F); when the system reaches this critical limit, it is necessary to stop the transmission and wait until the system returns to room temperature. Failure to do so may cause premature wear and/or catastrophic failure.

CU Single Chamber Assembly



> Specifications



The CU Single Chamber Assembly is a completely sealed, oil-bath configuration, indicated for those applications where the cycle duty requires a constant, continuously operated lubrication of all moving parts. This option is only applicable to the TP Series. It is imperative that the oil fill-up process is completed while the translating trapezoidal screw is fully lowered. In order to guarantee adequate adherence, it is recommended to use high-viscosity gear oils (1,000 mm²/s) with high-pressure PE Additives.

Unimec offers a wide selection of proprietary and recommended lubricants depending on the specific requirements of the applications. The CU Single Chamber Assembly also requires the installation of the PR Rigid Protection option to be used as a lubricant reservoir. A lubrication port is installed directly on the body of the unit while a drain plug is installed on the bottom of the PR Rigid Protection.

CU-PR-A Single Chamber Assembly with Dual-Guide Anti-Rotation System



> Specifications



The CU-PR-A Single Chamber Assembly with Dual-Guide Anti-Rotation System is the combination of our CU Single Chamber Assembly option and our PR-A Rigid Protection with Dual-Guide Anti-Rotation system. The CU Single Chamber Assembly is a completely sealed, oil-bath configuration, indicated for those applications where the service factor requires a constant, continuously operated lubrication of all moving parts. This option is only applicable to the TP Series. It is imperative that the oil fill-up process is completed while the translating trapezoidal screw is fully lowered. In order to guarantee adequate adherence, it is recommended to use high-viscosity gear oils (1,000 mm²/s) with high-pressure PE Additives. The CU-PR-A Single Chamber Assembly also requires the installation of the PR-A Rigid Protection

with Dual-Guide Anti-Rotation System: this option has a dual function as it serves both as a lubricant reservoir and as dual-guide anti-rotation. A lubrication port is installed directly on the body of the unit while a drain plug is installed on the bottom of the rigid protection. The Dual-Guide Anti-Rotation System is based on two linear guides embedded in the PR Rigid Protection and a no-friction Keniflon-treated bushing connected to the trapezoidal screw. In cases of longer strokes it is necessary to verify that torsional forces may not pose the risk of damaging the bushing. Finally, because the anti-rotation system locks the screw and the end-fitting in a specific position, it is always necessary to specify the exact position of special holes or asymmetrical/non-centered details in the trapezoidal screw.

DA Dual-Action



> Specifications



The DA Dual-Action is a special configuration capable of moving two separate loads with a single transmission. In the DA Dual-Action configuration, applicable to the TPR Series, the trapezoidal screw protrudes on both sides of the Screw Jack and can be executed in two versions: RH-LH (Right-Left) - the trapezoidal screw presents a Right thread on one side and a Left thread on the opposite side: this determines an opposing motion as illustrated

in picture 1; RH-RH (Right-Right) - the trapezoidal screw presents a Right thread on both sides: this determines a synchronous motion as illustrated in picture 2. Obviously, even the two loads can present opposing or synchronous directions, determining the following combinations. Please note that all load verifications must be calculated considering the total value of both loads.

FD Quick-Disconnect System



> Specifications



The FD Quick-Disconnect System allows a rapid disconnection of the trapezoidal screw from units in the TPR Series without requiring costly and time-consuming disassembly processes. The FD Quick-Disconnect System is based on two semi-lengths

of trapezoidal screw connected by special bolted TF flanges. The system obviously limits the total available stroke. The two TF flanges present a self-centering milled area to guarantee a quick and error-proof re-assembly.

FP Thruholes



> Specifications



The FP Thruholes option is an alternative mounting hole pattern typically used for larger size screw jacks. The use of thruholes may facilitate the installation of larger and heavier units.

Custom configurations with special diameter thruholes and alternative positions are available upon request depending on the dimensions of the unit.

GV Viton Seals

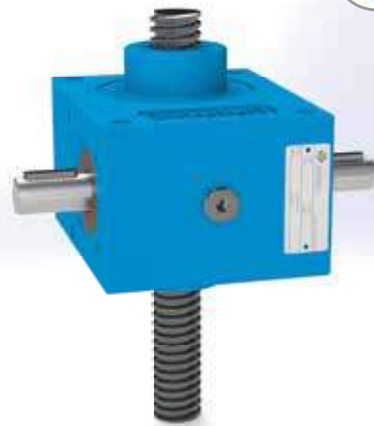

> Specifications



GV Viton Seals are used in cases of high temperature environments or when seals are subjected to high friction and consequent rising of temperatures. GV Viton seals are recommended in those applications with temperatures exceeding 80 ° C (176 ° F) and can operate up to a maximum of 200 ° C (392 ° F)

KL Lubrication Kit



> Specifications



It is imperative to always ensure that the trapezoidal screw is properly lubricated. Unimec offers a wide variety of lubricants for diverse applications. The standard lubricant is the UNIMEC Mark CA, a proprietary semi-fluid grease with PE additives, specifically formulated to excel with our materials and greatly enhance the lifetime of our units. The KL Lubrication Kits are available in three options: TGM125 - A simple 125 ml tube of UNIMEC Mark CA semi-fluid grease to be manually dispensed on the trapezoidal screw.

KL1 - A fully automated, gas-operated lubricant dispenser (model NOVA125) with 125 ml of UNIMEC Mark CA; the fully programmable lid of the device allows the operator to program the ideal lubrication interval, up to a full year of continuous operation. The KL1 Kit comes with a 40" long tube for indirect installation of the device, as well as all necessary brackets and hardware. KL2 includes all features of the KL1 and offers an additional tube of UNIMEC Mark CA semi-fluid grease for initial lubrication.

LUBS Special Lubricants



> Specifications



Unimec offers a wide range of non-standard lubricants for specific applications; typical applications include: Food-Grade Lubricant (suitable for food and beverage processing applications); Biological Lubricant (highly bio-degradable lubricant, suitable for applications where lubricant could accidentally come in contact with the environment); High-Temperature Lubricant (suitable for high temperature applications, low flammability); Low-temperature Lubricant (suitable for low-temperature applications,

refrigeration); Dielectric Lubricant (suitable for explosive-prone applications, avoids production and transmission of ions greatly reducing the risk of sparks); Nuclear Lubricant (suitable for nuclear applications, great resistance to radioactive degradation); White-Room Lubricant (suitable for white room applications, vacuum applications, etc., high molecular connectivity, low dispersion of particulates)

NLY Niploy-Coating Treatment



> Specifications



The NLY Niploy-Coating Treatment is a patented chemical-nickel coating used to enhance the resistance to corrosion and other aggressive agents of the non-moving parts of Screw Jacks, Bevel Gear Reducers and Speed Modulators.

P Lateral Pins



> Specifications



The P Lateral Pins option is used for oscillating, piston-rod configurations. Two protruding pins are mounted directly on two sides of the Screw Jack, becoming the pivotal point in the system. For this reason, this option may be preferable to the PO Oscillating Rigid Protection as it offers a more advantageous factor in the 2nd

Euler's Law: in fact, when using the formulae, the center-to-center distance from the pin to rod-end is exactly half compared to the center-to-center distance between the PO eyelet and the rod-end. Please keep in mind that the use of the P lateral Pins and a rod-end, does not eliminate lateral loads.

PE Elastic Bellow Protection



> Specifications



The PE Elastic Bellow Protection protects the trapezoidal screw from dust and debris. Standard bellows are made of PVC-coated Polyester and can be equipped with simple collar or flange end-fittings (available both in plastic or metal). The standard PVC-coated Polyester bellows are rated for temperatures between -30 °C and 70 °C (-20 °F / 160 °F). Optional bellow materials such as Neoprene® and Hypalon® (sea water resistant), Kevlar® (cut and abrasion resistant), Fiberglass (for extreme temperatures, from -50 °C to 250 °C (-60 °F / 480 °F)) and Aluminized Carbon Fiber (self-extinguishing material for use in applications with open fires and melted metals) are also available. If a waterproof seal is required, special bellows with thermo-sealed seals (vs. sewn)

are available. Please note that this option does not eliminate the risk of internal condensation. Finally, special bellow materials such as metal bellows or other materials for extreme applications are available upon request. In case of particularly long strokes, the PE Elastic Bellow Protection can be equipped with anti-stretching rings to allow a uniform opening and closing process. Please keep in mind that, in order to accommodate the fully retracted bellow, each PE Elastic Bellow Protection requires that the total trapezoidal screw length be increased by 1/8 of the stroke. In case of horizontal applications the PE Elastic Bellow Protection must be equipped with anti-collapsing rings. Please always specify the direction of the application.

PO Oscillating Rigid Protection

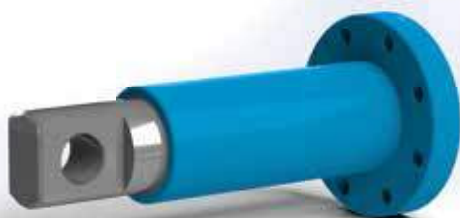

> Specifications



The PO Oscillating Rigid Protection is a special rigid protection with an eyelet in the lower extremity used in oscillating, piston-rod configurations. Please be aware that in this particular configuration, the payload is supported by the Rigid Protection tube and the lower eyelet; therefore, due to the risk of deflection, it is advisable to use caution with particularly long strokes. Please keep in mind that the

use of the PO Oscillating Rigid Protection and a rod-end, does not eliminate lateral loads. When working with compression loads, it is necessary to verify the load capacity under the 2nd Euler's Law: when using the formulae please consider the center-to-center distance between the eyelet and the rod-end. A motor can be installed directly on the screw jack.

PO-A Dual-Guide Anti-Rotation and Oscillating Rigid Protection

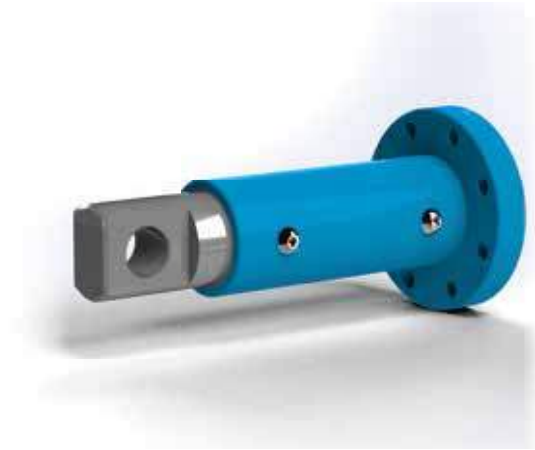

> Specifications

The PO-A Dual-Guide Anti-Rotation and Oscillating Rigid Protection is the combination of our PO Oscillating Rigid Protection and the Dual-Guide Anti-Rotation system and it is used in those oscillating, piston-rod applications where the user needs to contrast the inherent tendency to rotate that every screw jack presents. The PO-A Dual-Guide Anti-Rotation and Oscillating Rigid Protection, applicable on the TP Series, is a special Oscillating Rigid Protection (PO) with an eyelet in the lower extremity and two embedded linear guides with a no-friction Keniflon-treated bushing connected to the trapezoidal screw. In cases of longer strokes it is necessary to verify that torsional forces may not pose the risk of damaging the bushing.

Please keep in mind that the use of the PO-A and a rod-end, does not eliminate lateral loads. When working with compression loads, it is necessary to verify the load capacity under the 2nd Euler's Law: when using the formulae please consider the center-to-center distance between the eyelet and the rod-end. A motor can be installed directly on the screw jack. Finally, because the anti-rotation system locks the screw and the end-fitting in a specific position, it is always necessary to specify the exact position of special holes or asymmetrical/non-centered details in the trapezoidal screw.



PO-A-F Dual-Guide Anti-Rotation and Oscillating Rigid Protection with Stroke Control

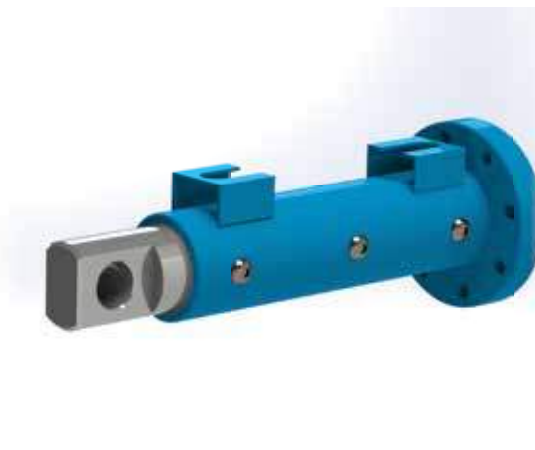

> Specifications

The PO-A-F Dual-Guide Anti-Rotation and Oscillating Rigid Protection with Stroke Control is the combination of our PO Oscillating Rigid Protection with our dual-guide anti-rotation system and stroke control. The PO-A-F Oscillating Rigid Protection with Stroke Control, applicable on all TP models, is a special PO Oscillating Rigid Protection with two milled areas to allow the installation of proximity switches and a dual-guide system with a no-friction Keniflon-treated bushing connected to the trapezoidal screw. Proximity switches are included and embedded in custom supports, specifically designed to be installed on the PR Rigid Protection. The special supports are made of two half-rings allowing ideal positioning and fine tuning of the proximity switches. The presence of O-Rings guarantees protection against dust, debris and moisture. It is possible to have more than two milled areas for multiple

proximity switches. Please be aware that in this particular configuration, the payload is supported by the Rigid Protection tube and the lower eyelet; therefore, due to the risk of deflection, it is advisable to use caution with particularly long strokes. In cases of longer strokes it is also necessary to verify that torsional forces may not pose the risk of damaging the bushing. Please keep in mind that the use of the PO Oscillating Rigid Protection and a rod-end, does not eliminate lateral loads. When working with compression loads, it is necessary to verify the load capacity under the 2nd Euler's Law: when using the formulae please consider the center to center distance between the eyelet and the rod-end. A motor can be installed directly on the Screw Jack. A BU Anti-Disengagement bushing is also required on the trapezoidal screw. Multiple BU Anti-Disengagement bushings can also be installed upon request.



PO-AR Oscillating Rigid Protection with Anti-Rotation System



> Specifications

The PO-AR Oscillating Rigid Protection with Anti-Rotation System is the combination of our PO Oscillating Rigid Protection and our AR Anti-Rotation System. The Oscillating Rigid Protection with Anti-Rotation System is based on a special rigid protection with an eyelet in the lower extremity and a full-length channel milled into the translating trapezoidal screw with a special collar and a key mounted on the cover of the Screw Jack. Please be aware that in this particular configuration, the payload is supported by the Rigid Protection tube and the lower eyelet; therefore, due to the risk of deflection, it is advisable to use caution with particularly long strokes. Please keep in mind that the milled channel causes a mechanical weakening of the trapezoidal screw resulting in a 40% reduction of the dynamic load capacity and

a 13% reduction of the static load capacity. Because of the milled channel, it is also recommended to use the AR Anti-Rotation System only when the F_a factor is < 1 . Also, please keep in mind that the use of the PO Oscillating Rigid Protection and a rod-end, does not eliminate lateral loads. When working with compression loads, it is necessary to verify the load capacity under the 2nd Euler's Law: when using the formulae please consider the center-to-center distance between the eyelet and the rod-end. A motor can be installed directly on the screw jack. Finally, because the AR Anti-Rotation system locks the screw and the end-fitting in a specific position, it is always necessary to specify the exact position of special holes or asymmetrical/non-centered details in the trapezoidal screw.

PO-BU Oscillating Rigid Protection with Anti-Disengagement Bushing



> Specifications

The PO-BU Oscillating Rigid Protection with Anti-Disengagement Bushing is the combination of our PO Oscillating Rigid Protection and our BU Anti-Disengagement Bushing and it is used in oscillating, piston-rod applications requiring that the trapezoidal screw be prevented from disengaging from the Screw Jack in the event of an accidental overstroke. The PO-BU Oscillating Rigid Protection with Anti-Disengagement Bushing, applicable on all TP models, is a special PO Oscillating Rigid Protection with a trapezoidal thread which guarantees the full load support during the attempted overstroke. Please be aware that in this particular configuration, the payload is supported by the Rigid Protection tube and the lower

eyelet; therefore, due to the risk of deflection, it is advisable to use caution with particularly long strokes. Please keep in mind that the use of the PO Oscillating Rigid Protection and a rod-end, does not eliminate lateral loads. When working with compression loads, it is necessary to verify the load capacity under the 2nd Euler's Law: when using the formulae please consider the center to center distance between the eyelet and the rod-end. A motor can be installed directly on the screw jack. Please keep in mind that even a single overstroke accident (with consequent impact of the BU Anti-Disengagement Bushing with the main body of the unit) can irreparably damage the internal gearing.

PO-F Oscillating Rigid Protection with Stroke Control



> Specifications

The PO-F Oscillating Rigid Protection with Stroke Control is the combination of our PO Oscillating Rigid Protection and our PR-F Electronic Stroke Control and it is used in oscillating, piston-rod applications requiring a stroke control. The PO-F Oscillating Rigid Protection with Stroke Control, applicable on TP models, is a special PO Oscillating Rigid Protection with two milled areas to allow the installation of proximity switches. Proximity switches are included on demand. It is possible to have more than two milled areas for multiple proximity switches. Please be aware that in this particular configuration, the payload is supported by the Rigid Protection tube and the lower eyelet; therefore, due to the risk of deflection, it is advisable to use caution with particularly long strokes. Please keep in

mind that the use of the PO-F and a rod-end, does not eliminate lateral loads. When working with compression loads, it is necessary to verify the load capacity under the 2nd Euler's Law: when using the formulae please consider the center to center distance between the eyelet and the rod-end. A motor can be installed directly on the Screw Jack. A BU Anti-Disengagement bushing is also required on the trapezoidal screw. Multiple BU Anti-Disengagement bushings can also be installed upon request.

PR Rigid Protection



> Specifications



A PR Rigid Protection, installed on the lower end of the Screw Jack, is the ideal way to protect the translating trapezoidal screw from dust and debris. The PR Rigid Protection can only be installed in Screw Jacks in the TP Series. Three set screws safely secure the protection tube onto the lower collar.

PR-A Dual Guide Anti Rotation System



> Specifications



The PR-A Dual Guide Anti Rotation System is used when it's difficult to create an external contrast to the inherent tendency to rotate that every screw jack presents. The PR-A Dual Guide Anti Rotation System, applicable on the TP Series, is based on two linear guides embedded in the PR Rigid Protection and a no-friction Keniflon-treated bushing connected to the trapezoidal screw.

In cases of longer strokes it is necessary to verify that torsional forces may not pose the risk of damaging the bushing. Finally, because the anti-rotation system locks the screw and the end-fitting in a specific position, it is always necessary to specify the exact position of special holes or asymmetrical/non-centered details in the trapezoidal screw.

PR-A-F Dual-Guide Anti-Rotation System with Stroke Control



> Specifications



The PR-A-F Dual-Guide Anti-Rotation System is used to control the stroke and contrast the inherent tendency to rotate that every screw jack presents. The PR-A-F Dual-Guide Anti-Rotation System with Stroke Control, is based on two linear guides embedded in the PR Rigid Protection and a no-friction Keniflon-treated bushing connected to the trapezoidal screw. In cases of longer strokes it is necessary to verify that torsional forces may not pose the risk of damaging the bushing. Finally, because the anti-rotation system locks the screw and the end-fitting in a specific position, it is always necessary to specify the exact position of special holes or asymmetrical/non-centered details in the trapezoidal screw.

The system consists of a special PR Rigid Protection with two milled areas to allow the installation of proximity switches. Proximity switches are included and embedded in custom supports, specifically designed to be installed on the PR Rigid Protection. The special supports are made of two half-rings allowing ideal positioning and fine tuning of the proximity switches. The presence of O-Rings guarantees protection against dust, debris and moisture. It is possible to have more than two milled areas for multiple proximity switches. A BU Anti-Disengagement bushing is also required on the trapezoidal screw. Multiple BU Anti-Disengagement bushings can also be installed upon request.

PR-A-O Oil-Bath Rigid Protection with Dual-Guide Anti-Rotation System



> Specifications

The PR-A-O Oil-Bath Rigid Protection with Dual-Guide Anti-Rotation System is the combination of our PR-O Oil Bath Rigid Protection and our Dual-Guide Anti-Rotation System. This option, applicable to the TP Series, performs three specific functions: protection of the trapezoidal screw from dust and debris, semi-automatic lubrication and prevention of the inherent tendency to rotation of the screw-jack. During the installation the PR-A-O Oil Bath Rigid Protection must be filled with the recommended lubricant. Every time the translating trapezoidal screw recedes in the PR-A-O Oil Bath Rigid Protection it receives a coat of lubricant. In order to guarantee adequate adherence, it is recommended to use high-viscosity gear oils (1,000 mm²/s) with high-pressure PE Additives. Unimec offers a wide selection of proprietary and recommended lubricants depending on the requirements of the

application. A lubrication port is installed directly on the body of the unit while a drain plug is installed on the bottom of the Rigid Protection. For applications with particularly long strokes it is recommended to add the TRO option: an oil-recirculation tube allowing the lubricant to flow from the gearbox to the rigid protection and compensate the pumping effect. The PR-A-O option also includes our Dual-Guide Anti-Rotation System based on two linear guides embedded in the PR Rigid Protection and a no-friction Keniflon-treated bushing connected to the trapezoidal screw. In cases of longer strokes it is necessary to verify that torsional forces may not pose the risk of damaging the bushing. Finally, because the anti-rotation system locks the screw and the end-fitting in a specific position, it is always necessary to specify the exact position of special holes or asymmetrical/non-centered details in the trapezoidal screw.

PR-F Electronic Stroke Control

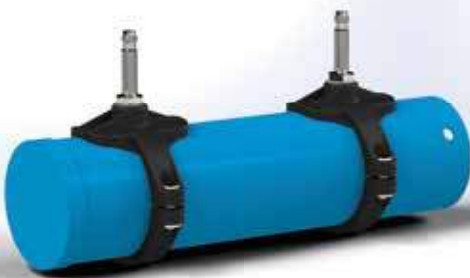

> Specifications

The PR-F Electronic Stroke Control accessory is available for all Screw Jacks in the TP Series. The standard system consists of a special PR Rigid Protection with two milled areas to allow the installation of proximity switches. Proximity switches are included and embedded in custom supports, specifically designed to be installed on the PR Rigid Protection. The special supports are made of two half-rings allowing the ideal positioning and fine tuning

of the proximity switches. The presence of O-Rings guarantees protection against dust, debris and moisture. It is possible to have more than two milled areas for multiple proximity switches. A BU Anti-Disengagement bushing is also required on the trapezoidal screw. Multiple BU Anti-Disengagement bushings can also be installed upon request.

PR-O Oil Bath Rigid Protection



> Specifications



The PR-O Oil Bath Rigid Protection option has a dual function: protection of the trapezoidal screw from dust and debris and semi-automatic lubrication. During installation the PR-O Oil Bath Rigid Protection must be filled with the recommended lubricant (depending on the application). Every time the translating trapezoidal screw recedes in the PR-O Oil Bath Rigid Protection, it receives a coat of lubricant. In order to guarantee adequate adherence, it is recommended to use high-viscosity gear oils (1,000 mm²/s) with high-pressure PE Additives.

A lubrication port is installed directly on the body of the unit while a drain plug is installed on the bottom of the PR-O Rigid Protection. For applications with particularly long strokes it is recommended to add the TRO option: an oil-recirculation tube allowing the lubricant to flow from the gearbox to the rigid protection and compensate the pumping effect.

RG-TP Axial Play Compensation Nut

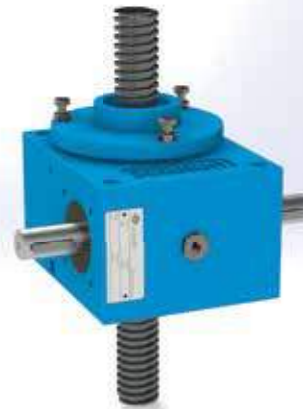

> Specifications



The RG-TP Axial Play Compensation Nut, applicable to the TP Series, is a special nut designed to compensate the natural (and necessary) play between the trapezoidal screw and the worm wheel. The RG-TP Axial Play Compensation Nut is particularly useful in applications where the load direction changes frequently from compression to traction and vice-versa. The reduction of play can be manually adjusted by rotating a special cover mounted on top of the play compensation nut.

Please be aware that an excessive reduction of play may determine premature wear and, in some cases, even a complete stop of the trapezoidal screw. Also, please be aware that the RG-TP Axial Play Compensation Nut causes a 40% reduction of Efficiency. Finally, please keep in mind that the area illustrated in the picture may present lubricant leaks and therefore it is necessary to opt for vertical mounting.

RG-TPR Axial Play Compensation Nut



> Specifications



The RG-TPR Axial Play Compensation Nut, applicable to the TPR Series, is a special nut designed to compensate the natural (and necessary) play between the trapezoidal screw and the translating nut. The RG-TP Axial Play Compensation Nut is particularly useful in applications where the load direction changes frequently from compression to traction and vice-versa. The RG-TPR Axial Play Compensation Nut is connected to the nut with the use of set-

screws: the reduction of play can be manually adjusted by rotating the set-screws. Please be aware that an excessive reduction of play may determine premature wear and, in some cases, even a complete stop of the translating nut. Also, please be aware that the RG-TPR Axial Play Compensation Nut causes a 40% reduction of Efficiency.

SP Mounting Plates



> Specifications



The SP Mounting Plates option is useful in those applications that do not allow the use of the pre-existing mounting holes on the body of the Screw Jack. Custom configurations with special hole patterns are available upon request.



TC Low Non-Threaded End-Fitting



> Specifications



TC Low Non-Threaded End-Fitting features a smaller diameter compared to the trapezoidal screw, ideal for the installation of an end-support bearing, typically in the TPR models.

An advanced version with integrated end-support bearing

and mounting flange is also available (TSC model). Custom configurations with special diameters, lengths and mounting hole patterns are available upon request.

TF Flange End-Fitting



> Specifications



The TF Flange End-Fitting is secured to the trapezoidal screw with a set screw. Thanks to the trapezoidal thread, the flange is capable of safely supporting the payload. Custom configurations with special mounting hole patterns are available upon request.

TFC Clevis Clip End-Fitting



> Specifications

The TFC Clevis Clip End-Fitting is mounted on the trapezoidal screw with a fine thread and features a clevis clip extremity ideal for oscillating applications. The Screw Jack can be equipped with the optional P Lateral Pins or with the PO Oscillating Rigid Protection.

TL Non-Threaded End Fitting



> Specifications

The TL Non-Threaded End-Fitting features a plain cylindrical extremity with the same diameter of the trapezoidal screw. Only cut screws (not rolled) can be supplied with the TL End-

Fitting option. Custom configurations with machined details, special diameters and lengths are available upon request.

TM Metric Thread End-Fitting



> Specifications



The TM threaded End-Fitting features a metric triangular thread that can be used to connect the trapezoidal screw to complex end-fittings or directly to the structure being moved. Custom configurations with special threads, diameters and lengths are available upon request.

TO Milled Eyelet End-Fitting



> Specifications



The TO Milled Eyelet End-Fitting is obtained by side-milling and drilling the trapezoidal screw and features an eyelet that can be equipped with a bushing or a hinge for oscillating configurations. The Screw Jack can be equipped with the optional P Lateral Pins or with the PO Oscillating Rigid Protection.

TOC Rod-End End-Fitting



> Specifications



The TOC Rod-End End-Fitting is mounted on the trapezoidal screw with a fine thread and features a rod-end extremity allowing oscillating configuration in presence of misalignments up to 13 degrees. The Screw Jack can be equipped with the optional P Lateral Pins or with the PO Oscillating Rigid Protection.

TOR Eyelet End-Fitting



> Specifications



The TOR Eyelet End-Fitting is mounted directly on the trapezoidal screw and features an eyelet for oscillating configurations; the TOR Eyelet End-Fitting allows the use of a bushing or a hinge. In an oscillating configuration, the screw jack can be equipped with the optional P Lateral Pins or with the PO Oscillating Rigid Protection. Custom configurations with special hole diameters are available upon request.

TPN Trapezoidal Thread End-Fitting

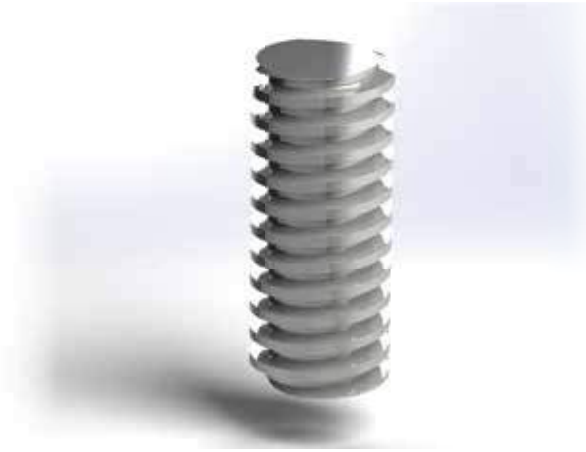

› Specifications



The TPN Trapezoidal Thread End-Fitting is a simple trapezoidal screw, cut to measure and deburred. Custom configurations with special holes and/or milled details are available upon request.

TSC Bearing-Support End-Fitting



› Specifications



The TSC Bearing-Support End-Fitting is used in the TPR Series and consists of a drilled flange with a radial ball bearing supporting the trapezoidal screw. This option allows a more accurate assembly and improves the performance of the Screw Jack. Custom configurations with special dimensions and mounting holes patterns are available upon request.

VE Epoxy Painting

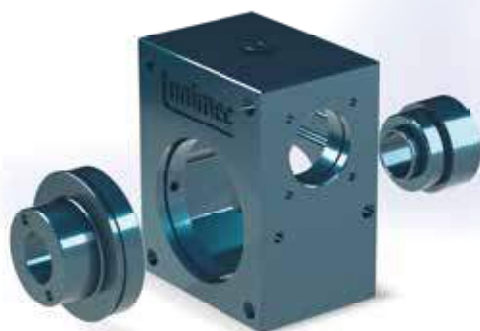

> Specifications



The VE Epoxy Painting is an optional painting based on a 3-stage process: stage 1 is a primer coat; stage 2 is a neutral coat base; stage 3 is the final color-coded coat. The end-result is aesthetically pleasant, with a rich gloss finish and improved resistance to

oxidation. Our epoxy painting is water-based and solvent-free and can be obtained in our standard RAL 5015 (Sky Blue) color. Custom colors may be obtained upon request.

Ball screw jacks



The ball screw jacks proposed in the K series are born from UNIMEC's experience in trapezoidal screw jacks. They can be employed for lifting, pulling, moving, aligning any kind of load with a perfect synchronism, which is difficult to obtain by means of other handling devices. The K series screw jacks are suitable for high services as well as for a very rapid, quick and precise positioning.

As compared to trapezoidal screw jacks, the K series presents a transmission reversibility: it is therefore advisable to provide for brakes, blockings or contrast torques in order to avoid a direction reversal. Screw jacks can be applied singularly or in groups properly connected with shafts, joints, and/or bevel gearboxes.

They can be driven by different motors: electrical, with either alternating or direct current, as well as hydraulic or pneumatic motors. Also they can be driven manually or with any other kinds of transmission. UNIMEC ball screw jacks are designed and

manufactured using innovative technology so to supply a product which identifies itself with the state of the art in the transmission devices.

The highest quality and a 37 years long experience are able to meet the most demanding and sophisticated requirements.

The special hollow shaft mounting allows to assemble any kind of ball spindles available on the market, making the K series really universal. The outer surfaces are completely machine finished and the parts are assembled with special care, in order to allow the application of supports, flanges, pins, or any other components a mounting may require. Special sealing systems enable the inner gears to operate in a bath of lubricant, which guarantees them a long lasting life. Moreover the following models, UNIMEC can realize any special transmission a design may require.

Handling

MANUAL AND MOTORIZED OPERATION

The K series only presents one ratio for all three sizes: an exact 1/5. This allows a great deal of precision in the couplings. All the K series can be manually or motor operated. As a standard production, for the IEC unified motors, it is possible to connect them directly to screw jacks. Special flanges can be made for hydraulic motors, pneumatic motors, brushless motors, as well as for direct current motors, permanent magnet motors, stepper motors and other special motors. In the case where it is not possible to motorize a screw jack directly, a connection by means of an housing and a joint can be foreseen. The power curves determine, in case of unit service factors and for every single screw jack, the moving power and the input torque according to the size and the requested output torque.

ROTATION DIRECTIONS

In standard conditions UNIMEC supplies K series screw jacks equipped with right-handed worm screw, to which correspond the movements illustrated in the drawings below.

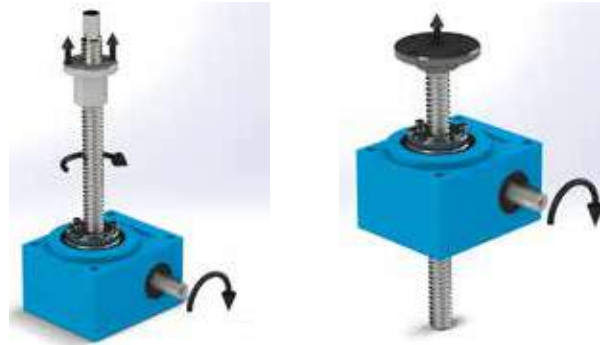

Lubrication

The lubrication of the inner transmission devices to the casing is made, in the series production, using a synthetic oil having marked tribologic characteristics: UNIMEC ATIR SH150.

The technical specifications and the application field for the lubricant inside the casing are shown below.

Lubricant	Application field	Operating temperature [°C]*	Technical specifications
UNIMEC ATIR SH150 (not compatible with PAO based mineral and synthetic oils)	standard	-20 : + 200	DIN 51517-3: CLP NF ISO 6743-6: CKD
Total Nevastane SY 320 (not compatible with PAO based mineral and synthetic oils)	food industry	-20 : + 250	NSF-USDA: H1

* for operating temperatures between 80°C and 150°C Viton® seals should be used;
for temperatures higher than 150°C and lower than -20°C it is advisable to contact our technical office.

BALL SPINDLE

The end user is responsible for the lubrication of the ball spindle which must be carried out using a lubricant suggested by the manufacturer. Lubricating the ball spindle is an important and determining factor for the proper functioning of the screw jack. It must be carried out at regular intervals that can assure a constant coat of clean lubricant between the contact parts.

Insufficient lubrication, or an improper lubrication can lead to abnormal overheating and consequent wear phenomena, which naturally reduce the operating life of the screw jacks. In case the screw jacks are not visible or the ball spindles are covered by protections it is necessary to periodically verify the lubrication conditions.

Backlash

BACKLASH ON THE WORM SCREW

The worm screw – worm wheel coupling has a small degree backlash. Under the effect of the reduction ratio and of the transformation from the rotation movement to the translation movement, this backlash becomes an error in the linear positioning

of a few hundredths of a millimetre, according to the diameter and pitch of the ball spindle. For all other backlashes (lateral and axial) between the spindle and the lead nut it is necessary to refer to the ball spindle manufacturers catalogues.

Installation and maintenance

INSTALLATION

When arranging the ball screw jack and coupling it to machines, pay attention to the axis alignment. Failing an exact alignment, the bearings would be subjected to a greater overloading and anomalous overheating as well as to a greater wear, with a consequent reduction of their operating life. It is important to check that the spindle and the casing mounting plane be orthogonal and that the load and the spindle be on the same axis. Employing multiple screw jacks to handle the same load (see the mounting schemes section) requires further verifications: it is critical that the load support points, (the end fittings for KT models and the lead nuts for KR models), be perfectly aligned in order that the load can be uniformly distributed; otherwise the misaligned screw jacks would act as brake or counter-load. Whenever several jacks have to be connected by means of transmission shafts, it is recommended that they be perfectly aligned in order to avoid overloading the worm screws. It is advisable to use joints capable of absorbing alignment errors without losing the torsion strength necessary to keep the synchronization of the transmission. It is necessary to mount the transmission in a way to avoid any displacement or vibrations, keeping attention to the fixing by means of bolts or tie rods. Before assembling the connection parts it is necessary to properly clean the contact surfaces in order to avoid any seizing and oxidizing problems. Assembly or disassembly shall occur by means of tie rods or extractors, using the threaded hole on the shaft end. In case of forced couplings, a shrink-fitting is recommended with a temperature up to 80-100°C.

Installations environments with dust, water, vapors, etc. require precautions to protect the ball spindle, such as elastic protections (bellows) and rigid protections. The above protections are also used in order to avoid any accidental human contact with the moving devices. For civil applications it is always advisable to use the safety components.

PREPARING FOR SERVICE

All UNIMEC's screw jacks are supplied filled with long lasting lubricant which ensures a perfect lubrication of the worm gear/worm wheel group and all the inner parts. All K series screw jacks are equipped with a lubricant filling cap, a drain cap and an oil level indicator in order to allow the filling-up of the lubricant as necessary. As clearly explained on the relative paragraph, lubrication of the ball spindle is a user's responsibility and it must be carried out periodically depending on the service conditions and the operating environment. Special sealing systems allow to hold the screw jacks in any position without creating leakage problems. The application of some accessories can limit these assembly possibilities: the various solutions to be adopted will be explained in the relevant paragraphs. Some screw jacks are equipped with an "add oil" label.

The installer shall carry out the necessary oil filling when gears are not working. Fillings should not be excessive in order to avoid any overheating, noise, inner pressure increase and power loss problems.

START-UP

All screw jacks undergo a careful quality examination before being delivered to the client, and are dynamically tested load-free. When starting-up a machine where screw jacks are installed, it is critical to check for the lubrication of the ball spindles and for the absence of foreign material. During the calibration of the electrical end-of-stroke systems, the inertia of the moving masses should be taken into account, which for vertical loads will be lower in ascent and greater in descent. Some hours of operation at full load are necessary before the screw jack reaches its maximum running efficiency. The screw jacks can be placed under a full load immediately if necessary. In some circumstances, it is nonetheless advisable to operate the screw jack under increasing loads, reaching maximum load after 20-30 hours of operation. It is likewise recommended to take due precautions to avoid overloads in the initial stages of operation. There may be a higher temperature during these initial stages but this will be reduced once the screw jacks is completely run in.

ROUTINE MAINTENANCE

Screw jacks must be periodically inspected, depending on the level of use and work conditions. It is advisable to check for losses of lubricant from the casing, and if this occurs, it is necessary to find and eliminate the cause and fill the lubricant up the correct level. The lubrication conditions of the ball spindle must be periodically inspected (and restored if necessary) as well as the presence of any foreign material. All safety devices should be verified according to the normative in force.

STORAGE

The screw jacks must be protected from deposits of dust and foreign matter during storage. Particular attention must be paid to saline or corrosive atmospheres.

We also recommend to:

- periodically rotate the worm screw to ensure proper lubrication of inner parts and avoid that the seals dry up, therefore causing lubricant losses.
- lubricate and protect the threaded spindle, the worm screw and the non varnished components
- support the ball spindle in case of horizontal storage.

WARRANTY

The warranty is valid only if the instructions contained in our manual are carefully followed.

K Model

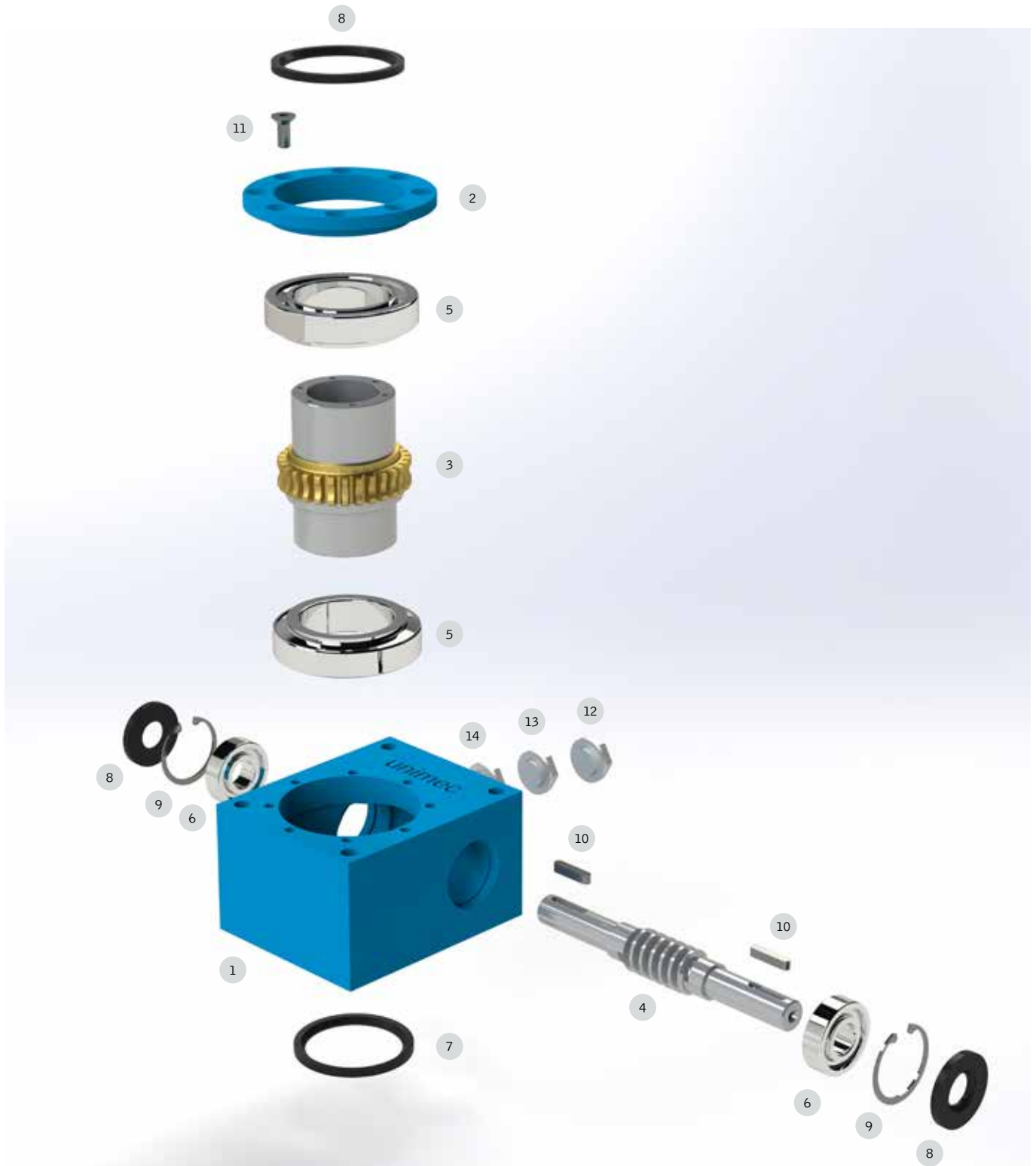

1 Casing	5 Worm wheel bearing	9 Snap ring	13 Oil level indicator
2 Cover	6 Worm screw bearing	10 Key	14 Drain cap
3 Worm wheel	7 Seal	11 Bolt	
4 Worm screw	8 Seal	12 Filling cap	

MK Model

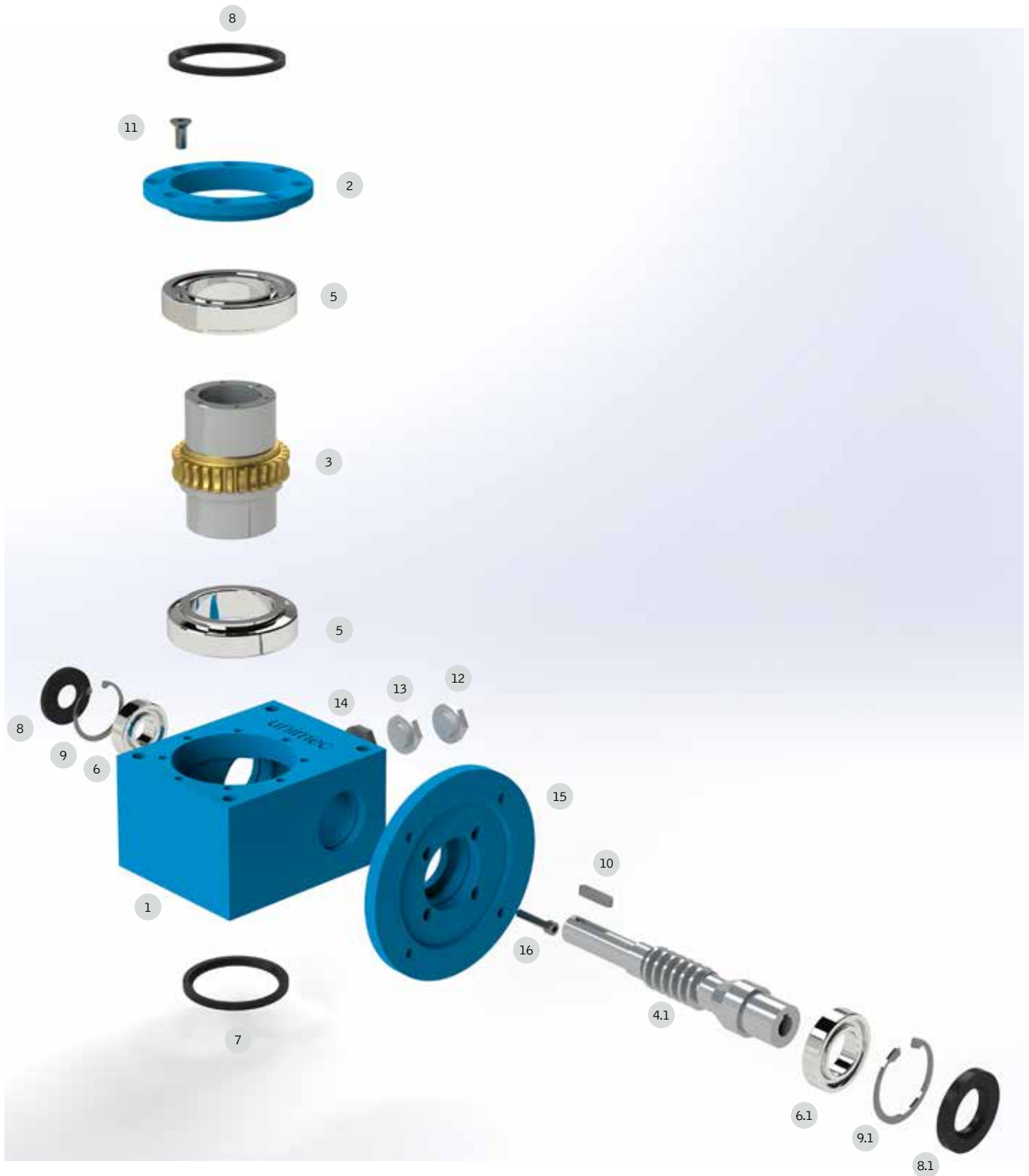

1 Casing	6 Worm screw bearing	9 Snap ring	13 Oil level indicator
2 Cover	6.1 Motori worm screw bearing	9.1 Snap ring for motoring	14 Drain cap
3 Worm wheel	7 Seal	10 Key	15 Motor flange
4.1 Motor worm screw	8 Seal	11 Bolt	16 Bolt
5 Worm wheel bearing	8.1 Seal for motoring	12 Filling cap	

Size 59



K Model



KT Model

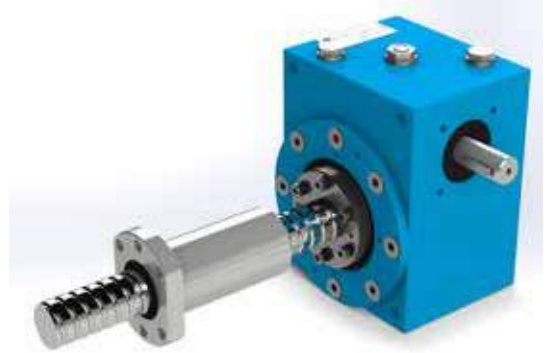

KR Model

Materials

	Material	Norms	Specs	Indications
Worm	16NiCr4	EN 10084:2008	Casehardening alloy steel	Casehardened and ground on teeth and holds
Carter	GJL 250	EN 1561:2011	Grey cast iron	Completely machined on 6 faces
Worm wheel	Bronze CuSn12 and grey cast iron GJL250	EN 10084:2008 and EN 1561:2011	Wheel casted in bi-metal	
Lubricant	Unimec Atir SH150		Synthetic oil	0,3 lt

General features

Efficiency	85 %
Operating temperature	-10 °C / 80 °C
Max input speed	3000 rpm
Main Gearbox Weight	15 kg
Max admissible lateral loads	0 N
Center-to-center distance	59 mm
Max radial Load on worm Screw	450 N
Standard Working Conditions	25 °C - regular work - 10.000 hours of expected life

Specific features

	Nominal Ratios
	1/5
Real ratio	1/5
Worm screw maximum torque	315 Nm
Inertia moment	4060 kg·mm ²

› Power curves

The magenta zone indicates a potential heating risk. Working cycles must be carefully analyzed.

VR = Worm rotational speed [rpm]

VL = Spindle translation speed [mm/min]

P = Requested input power [kW]

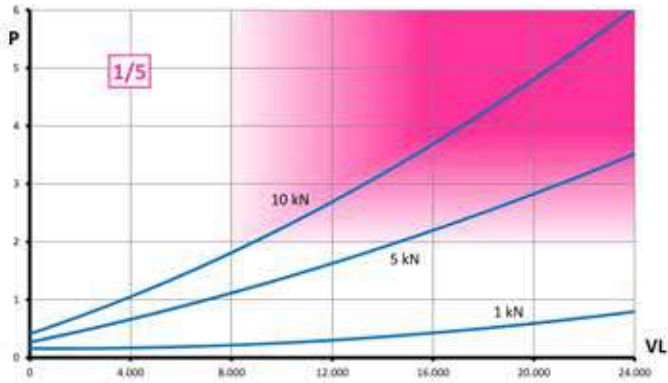

› Motor Models



IEC	Worm screw bore diameter	Centering diameter	Nominal power (4 poles motor)
IEC 71 B5 / B14	14 mm	110 mm / 70 mm	0,55 kW
IEC 80 B5 / B14	19 mm	130 mm / 80 mm	1,1 kW

› Construction Forms



Form B



Form D



Form S



Form MBD



Form MD



Form MS



Form MBS

Size 88



K Model



KT Model

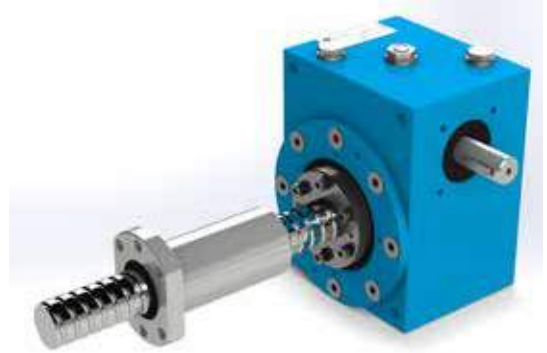

KR Model

Materials

	Material	Norms	Specs	Indications
Worm	16NiCr4	EN 10084:2008	Casehardening alloy steel	Casehardened and ground on teeth and holds
Carter	GJL 250	EN 1561:2011	Grey cast iron	Completely machined on 6 faces
Worm wheel	Bronze CuSn12 and grey cast iron GJL250	EN 10084:2008 and EN 1561:2011	Wheel casted in bi-metal	
Lubricant	Unimec Atir SH150		Synthetic oil	0,8 lt

General features

Efficiency	85 %
Operating temperature	-10 °C / 80 °C
Max input speed	3000 rpm
Main Gearbox Weight	40 kg
Max admissible lateral loads	0 N
Center-to-center distance	88 mm
Max radial Load on worm Screw	600 N
Standard Working Conditions	25 °C - regular work - 10.000 hours of expected life

Specific features

	Nominal Ratios 1/5
Real ratio	1/5
Worm screw maximum torque	610 Nm
Inertia moment	25500 kg-mm ²

› Power curves

The magenta zone indicates a potential heating risk. Working cycles must be carefully analyzed.

VR = Worm rotational speed [rpm]

VL = Spindle translation speed [mm/min]

P = Requested input power [kW]

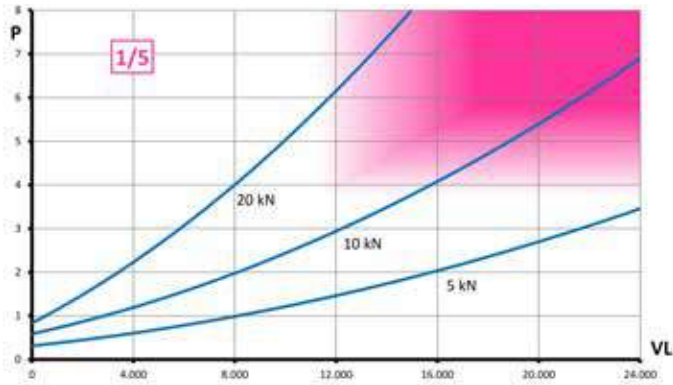

› Motor Models



IEC	Worm screw bore diameter	Centering diameter	Nominal power (4 poles motor)
IEC 80 B5 / B14	19 mm	130 mm / 80 mm	1,1 kW
IEC 90 B5 / B14	24 mm	130 mm / 95 mm	1,9 kW
IEC 100-112 B5 / B14	28 mm	180 mm / 110 mm	5 kW

› Construction Forms



Form B



Form D



Form S



Form MBD



Form MD



Form MS



Form MBS

Size 117



K Model



KT Model

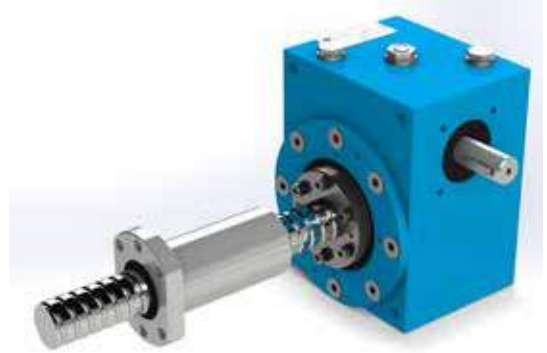

KR Model

› Materials

	Material	Norms	Specs	Indications
Worm	16NiCr4	EN 10084:2008	Casehardening alloy steel	Casehardened and ground on teeth and holds
Carter	GJL 250	EN 1561:2011	Grey cast iron	Completely machined on 6 faces
Worm wheel	Bronze CuSn12 and grey cast iron GJL250	EN 10084:2008 and EN 1561:2011	Wheel casted in bi-metal	
Lubricant	Unimec Atir SH150		Synthetic oil	1,2 lt

› General features

Efficiency	85 %
Operating temperature	-10 °C / 80 °C
Max input speed	3000 rpm
Main Gearbox Weight	64 kg
Max admissible lateral loads	0 N
Center-to-center distance	117 mm
Max radial Load on worm Screw	900 N
Standard Working Conditions	25 °C - regular work - 10.000 hours of expected life

› Specific features

	Nominal Ratios
	1/5
Real ratio	1/5
Worm screw maximum torque	1050 Nm
Inertia moment	80000 kg-mm ²

Power curves

The magenta zone indicates a potential heating risk. Working cycles must be carefully analyzed.

VR = Worm rotational speed [rpm]

VL = Spindle translation speed [mm/min]

P = Requested input power [kW]

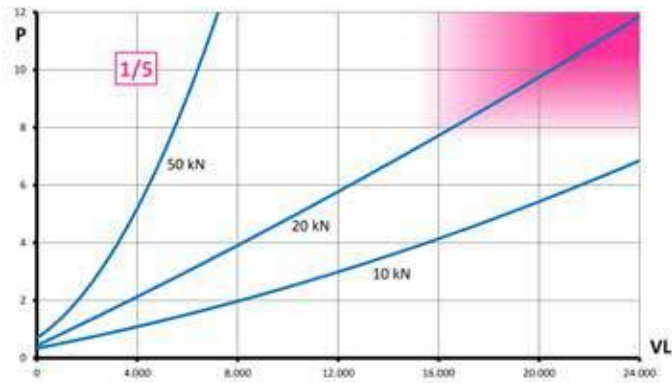

Motor Models

	IEC	Worm screw bore diameter	Centering diameter	Nominal power (4 poles motor)
	IEC 132 B5 / B14	38 mm	230 mm / 130 mm	9,2 kW

Construction Forms



Form B



Form D



Form S



Form MBD



Form MD



Form MS



Form MBS

BU Anti-Disengagement Bushing



› Specifications



The BU Anti-Disengagement Bushing is a safety device preventing the translating ball screw from disengaging from the screw jack in the event of an accidental overstroke. The BU Anti-Disengagement Bushing features a trapezoidal thread which guarantees the full load support during the attempted overstroke. The BU Anti-Disengagement Bushing can only be installed in models with

translating spindle. If the PRF Stroke Control accessory is also installed on the Screw Jack, the BU Anti-Disengagement Bushing will work as an additional end-stroke safety device. Please keep in mind that even a single overstroke accident (with consequent impact of the BU Anti-Disengagement Bushing with the main body of the unit) can irreparably damage the internal gearing.

CAPP Worm Screw Protection Cover



› Specifications



The CAPP Worm Screw Protection Cover is a rigid plastic protection that covers one of the worm screw extremities protecting it from accidental collisions, dust and debris. It also works as a safety device protecting live operators from moving parts.

The CAPP Worm Screw Protection Cover can only be installed on Screw Jacks in the B Construction Form.

CT Temperature Control



> Specifications



The CT Temperature Control option is based on a temperature measuring probe, installed directly on the body of the unit and capable of measuring temperature variations between $-40\text{ }^{\circ}\text{C}$ ($-40\text{ }^{\circ}\text{F}$) and $90\text{ }^{\circ}\text{C}$ ($194\text{ }^{\circ}\text{F}$). As power transmissions, screw jacks tend to dissipate a significant amount of input power in the form of heat; the CT Temperature Control is recommended in all those applications where temperature monitoring is a critical factor.

It is recommended to never exceed the upper limit of $80\text{ }^{\circ}\text{C}$ ($176\text{ }^{\circ}\text{F}$); when the system reaches this critical limit, it is necessary to stop the transmission and wait until the system returns to room temperature. Failure to do so may cause premature wear and/or catastrophic failure.

CVR Rotating Spindle Sleeve



> Specifications



In order to assemble rotating ball spindles into the main body of the jack, it's necessary that their end fitting diameter will be minor than the hollow shaft ones (particularly 48, 72 and 105 mm for sizes 59, 88 and 117). A special sleeve between spindles and the hollow shaft connects both components.

FDR Reduction Flange



> Specifications



Reduction flange is an accessory that allow the assembling of a ball nut into the jack worm wheel. By this accessory it's possible to assemble different sizes of ball spindels in one only jack model: this is the reason why K series is an universal one.

P Lateral Pins



> Specifications



The P Lateral Pins option is used for oscillating, piston-rod configurations. Two protruding pins are mounted directly on two sides of the Screw Jack, becoming the pivotal point in the system. For this reason, this option may be preferable to the PO Oscillating Rigid Protection as it offers a more advantageous factor in the 2nd

Euler's Law: in fact, when using the formulae, the center-to-center distance from the pin to rod-end is exactly half compared to the center-to-center distance between the PO eyelet and the rod-end. Please keep in mind that the use of the P Lateral Pins and a rod-end, does not eliminate lateral loads.

PE Elastic Bellow Protection



> Specifications

The PE Elastic Bellow Protection protects the ball screw from dust and debris. Standard bellows are made of PVC-coated Polyester and can be equipped with flange end-fittings (available both in plastic or metal). The standard PVC-coated Polyester bellows are rated for temperatures between -30 °C and 70 °C (-20 °F / 160 °F). Optional bellow materials such as Neoprene® and Hypalon® (sea water resistant), Kevlar® (cut and abrasion resistant), Fiberglass (for extreme temperatures, from -50 °C to 250 °C (-60 °F / 480 °F)) and Aluminized Carbon Fiber (self-extinguishing material for use in applications with open fires and melted metals) are also available. If a waterproof seal is required, special bellows with thermo-sealed seals (vs. sewn) are available. Please note that this option does not eliminate the risk of internal condensation.

Finally, special bellow materials such as metal bellows or other materials for extreme applications are available upon request. In case of particularly long strokes, the PE Elastic Bellow Protection can be equipped with anti-stretching rings to allow a uniform opening and closing process. Please keep in mind that, in order to accommodate the fully retracted bellow, each PE Elastic Bellow Protection requires that the total ball screw length be increased by 1/8 of the stroke. In case of horizontal applications the PE Elastic Bellow Protection must be equipped with anti-collapsing rings. Please always specify the direction of the application.



PO Oscillating Rigid Protection

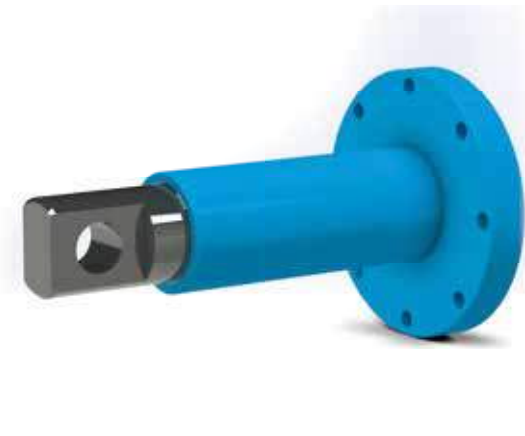

> Specifications

The PO Oscillating Rigid Protection is a special rigid protection with an eyelet in the lower extremity used in oscillating, piston-rod configurations. Please be aware that in this particular configuration, the payload is supported by the Rigid Protection tube and the lower eyelet; therefore, due to the risk of deflection, it is advisable to use caution with particularly long strokes. Please keep in mind that the

use of the PO Oscillating Rigid Protection and a rod-end, does not eliminate lateral loads. When working with compression loads, it is necessary to verify the load capacity under the 2nd Euler's Law: when using the formulae please consider the center-to-center distance between the eyelet and the rod-end. A motor can be installed directly on the screw jack.



PO-A Dual-Guide Anti-Rotation and Oscillating Rigid Protection

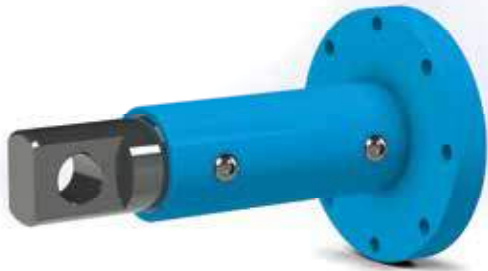

› Specifications

The PO-A Dual-Guide Anti-Rotation and Oscillating Rigid Protection is the combination of our PO Oscillating Rigid Protection and the Dual-Guide Anti-Rotation system and it is used in those oscillating, piston-rod applications where the user needs to contrast the inherent tendency to rotate that every screw jack presents. The PO-A Dual-Guide Anti-Rotation and Oscillating Rigid Protection, applicable on the KT Series, is a special Oscillating Rigid Protection (PO) with an eyelet in the lower extremity and two embedded linear guides with a no-friction Keniflon-treated bushing connected to the trapezoidal screw. In cases of longer strokes it is necessary to

verify that torsional forces may not pose the risk of damaging the bushing. Because the anti-rotation system locks the screw and the end-fitting in a specific position, it is always necessary to specify the exact position of special holes or asymmetrical/non-centered details in the ball screw. Please keep in mind that the use of the PO-A and a rod-end, does not eliminate lateral loads. When working with compression loads, it is necessary to verify the load capacity under the 2nd Euler's Law: when using the formulae please consider the center-to-center distance between the eyelet and the rod-end. A motor can be installed directly on the screw jack.

PO-F Oscillating Rigid Protection with Stroke Control



› Specifications

The PO-F Oscillating Rigid Protection with Stroke Control is the combination of our PO Oscillating Rigid Protection and our Electronic Stroke Control and it is used in oscillating, piston-rod applications requiring a stroke control. The PO-F Oscillating Rigid Protection with Stroke Control, applicable on KT models, is a special PO Oscillating Rigid Protection with two milled areas to allow the installation of proximity switches. Proximity switches are included on demand. It is possible to have more than two milled areas for multiple proximity switches. Please be aware that in this particular configuration, the payload is supported by the Rigid Protection tube and the lower eyelet; therefore, due to the

risk of deflection, it is advisable to use caution with particularly long strokes. Please keep in mind that the use of the PO-F and a rod-end, does not eliminate lateral loads. When working with compression loads, it is necessary to verify the load capacity under the 2nd Euler's Law: when using the formulae please consider the center to center distance between the eyelet and the rod-end. A motor can be installed directly on the Screw Jack. A BU Anti-Disengagement bushing is also required on the ball screw. Multiple BU Anti-Disengagement bushings can also be installed upon request.

PR Rigid Protection

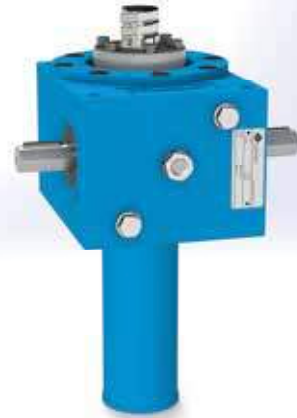

> Specifications



A PR Rigid Protection, installed on the lower end of the Screw Jack, is the ideal way to protect the translating ball screw from dust and debris. The PR Rigid Protection can only be installed in Screw Jacks in the KT Series. The protection is fixed to the main body by a flange.

PR-A Dual Guide Anti Rotation System



> Specifications



The PR-A Dual Guide Anti Rotation System is used when it's difficult to create an external contrast to the inherent tendency to rotate that every screw jack presents. The PR-A Dual Guide Anti Rotation System, applicable on the KT Series, is based on two linear guides embedded in the PR Rigid Protection and a no-friction Keniflon-treated bushing connected to the ball screw.

In cases of longer strokes it is necessary to verify that torsional forces may not pose the risk of damaging the bushing. Finally, because the anti-rotation system locks the screw and the end-fitting in a specific position, it is always necessary to specify the exact position of special holes or asymmetrical/non-centered details in the ball screw.

PR-A-F Dual-Guide Anti-Rotation System with Stroke Control

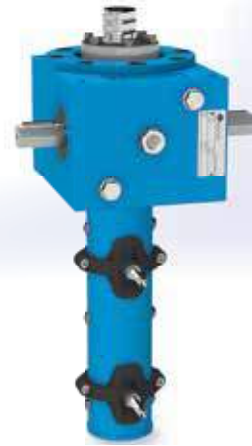

> Specifications

The PR-A-F Dual-Guide Anti-Rotation System is used to control the stroke and contrast the inherent tendency to rotate that every screw jack presents. The PR-A-F Dual-Guide Anti-Rotation System with Stroke Control, is based on two linear guides embedded in the PR Rigid Protection and a no-friction Keniflon-treated bushing connected to the ball screw. In cases of longer strokes it is necessary to verify that torsional forces may not pose the risk of damaging the bushing. Finally, because the anti-rotation system locks the screw and the end-fitting in a specific position, it is always necessary to specify the exact position of special holes or asymmetrical/non-centered details in the ball screw.

The system consists of a special PR Rigid Protection with two milled areas to allow the installation of proximity switches. Proximity switches are included and embedded in custom supports, specifically designed to be installed on the PR Rigid Protection. The special supports are made of two half-rings allowing ideal positioning and fine tuning of the proximity switches. The presence of O-Rings guarantees protection against dust, debris and moisture. It is possible to have more than two milled areas for multiple proximity switches. A BU Anti-Disengagement bushing is also required on the trapezoidal screw. Multiple BU Anti-Disengagement bushings can also be installed upon request.

PR-F Electronic Stroke Control



> Specifications

The PR-F Electronic Stroke Control accessory is available for all Screw Jacks in the KT Series. The standard system consists of a special PR Rigid Protection with two milled areas to allow the installation of proximity switches. Proximity switches are included and embedded in custom supports, specifically designed to be installed on the PR Rigid Protection. The special supports are made of two half-rings allowing the ideal positioning and fine tuning

of the proximity switches. The presence of O-Rings guarantees protection against dust, debris and moisture. It is possible to have more than two milled areas for multiple proximity switches. A BU Anti-Disengagement bushing is also required on the trapezoidal screw. Multiple BU Anti-Disengagement bushings can also be installed upon request.

PR-O Oil Bath Rigid Protection

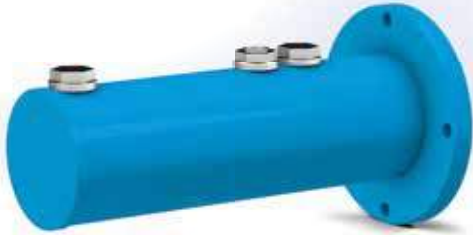

> Specifications



The PR-O Oil Bath Rigid Protection option has a dual function: protection of the ball screw from dust and debris and semi-automatic lubrication. During installation the PR-O Oil Bath Rigid Protection must be filled with the recommended lubricant (depending on the application). Every time the translating ball screw recedes in the PR-O Oil Bath Rigid Protection, it receives a coat of lubricant. In order to guarantee adequate adherence, it is recommended to use high-viscosity gear oils (1,000 mm²/s) with high-pressure PE Additives.

Unimec offers a wide selection of proprietary and recommended lubricants. A lubrication port is installed directly on the body of the unit while a drain plug is installed on the bottom of the PR-O Rigid Protection. For applications with particularly long strokes it is recommended to add the TRO option: an oil-recirculation tube allowing the lubricant to flow from the gearbox to the rigid protection and compensate the pumping effect.

SP Mounting Plates



> Specifications



The SP Mounting Plates option is useful in those applications that do not allow the use of the pre-existing mounting holes on the body of the Screw Jack. Custom configurations with special hole patterns are available upon request.



Bevel Gearboxes

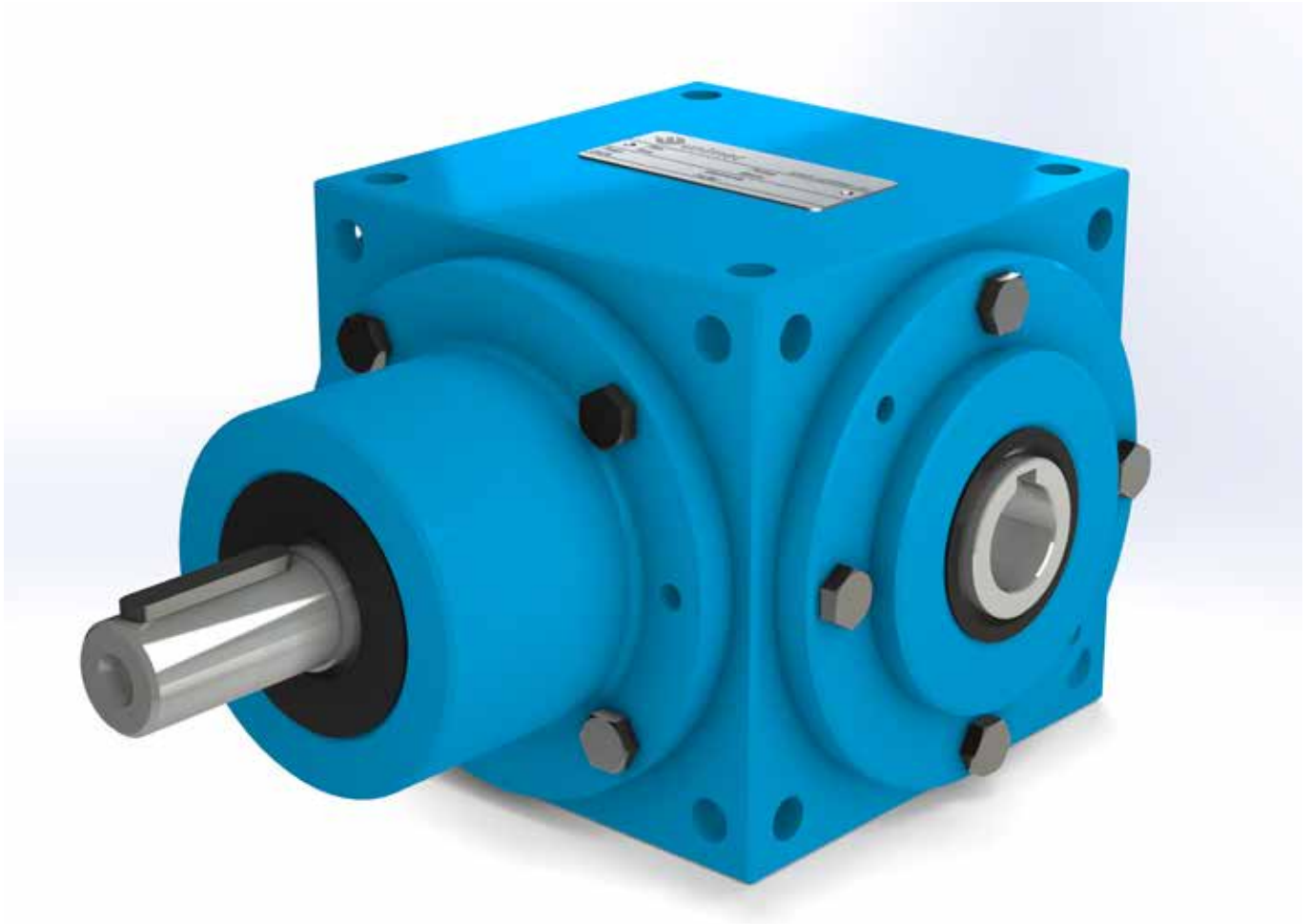

UNIMEC bevel gearboxes have been designed and manufactured since 37 years using an in-the van technology and mechanical solutions according to the state of the art to be able to meet the growing requirements of a demanding and sophisticated market. Nine sizes, tenths of mounting schemes, a range of serial ratios up to 1/12 and the possibility of a customized design having no equal, make of UNIMEC a reliable partner in the field of the motion transmission. The practical cubic shape of bevel gearboxes allows universal mounting possibilities on every kind of machines.

Bevel gearboxes are also very versatile with regard to the shafts choice and the possibility of a direct mounting on any kind of motors, from the normal IEC to brushless motors, to pneumatic motors and so on. High running efficiency, low noise are the logical consequences of the application of Gleason® type spiral teeth conical gears; the use of this kind of geometry and suitable thermal treatments place UNIMEC's bevel gearboxes on top of this mechanical sector.

Handling

All bevel gearboxes can be manually operated. Anyway most part of its application foresees a motorized handling, in many cases even direct. For the sizes from 86 to 250 included, it is possible to connect directly a standard IEC motor to the fast shaft of the bevel gearbox. Special flanges can be provided for all sizes made for hydraulic, pneumatic, brushless motors, as well as for direct current motors, permanent magnet motors, stepper motors and other special motors. It is also possible to realize special flanges for fixing the drive shaft by means of a shrink disk, in order to minimize the transmission backlash. The power curves determine the motoring power and the torque on the slow shaft, for each single bevel gearbox, in case of unique service factors, according to the model, size, ratio and revolution speeds.

ROTATION DIRECTIONS

The rotation directions depend on the mounting scheme. According to the chosen model, as a function of the required rotation direction, it's possible to choose the mounting scheme which best meets those requirements. We remind that, even if one only rotation direction of a shaft is changed from clockwise into anti-clockwise (and vice-versa), any other rotations of the bevel gearbox shafts direction must be reversed.

NON-STOP OPERATION

A non-stop operation occurs when the speed modulation gear is subjected to time constant torque and angular speed. After a transition period the revolutions become stationary, together with the surface temperature of the bevel gearbox and the ambient thermal exchange. It is important to check for wear phenomena and thermal power.

INTERMITTENT OPERATION

An intermittent operation occurs when high grade accelerations and deceleration overlap a revolution speed and torque (even at zero value), make it necessary to verify the ability to counteract the system inertia. A revision of the bevel gearbox and the input power is therefore necessary. It is important to check bending and fatigue strength parameters.

Lubrication

The lubrication of the inner transmission devices (gears and bearings) is made using a synthetic oil with extreme pressure additive: UNIMEC ATIR SH150. For a proper operation of the transmission it is advisable to steady check for lubricant leakage.

For all sizes a plug for lubricant filling-up is foreseen. The technical specifications and the application field for the lubricant inside the bevel gearboxes are listed below.

Lubricant	Application field	Operating temperature [°C]*	Technical specifications
UNIMEC ATIR SH150 (not compatible with polyglycol oils)	standard	0 : +200	AGMA 9005: E02 DIN 51517-3: CLP NF ISO 6743-6: CKD
Total Nevastane SL 220	food industry	-30 : +230	NSF-USDA: H1

* for operation temperatures between 80°C and 150°C Viton® seals should be used;
for temperatures higher than 150°C and lower -20°C it is advisable to contact our technical office.

The inner devices of the bevel gearboxes can be lubricated in two ways: by means of splash or forced lubrication. Splash lubrication does not require external interventions: when the fast shaft revolutions are lower than indicated in the graph below, its operation ensures that lubricant reaches all the components requiring lubrication. For revolution speeds higher than the indicated values, it may happen that the gears peripheral speed be such as to create centrifugal forces able to overcome the lubricant adhesivity. Therefore, in order to ensure a proper lubrication, a lubricant feeding under pressure is necessary (we suggest 5 bar) by means of a suitable oil cooling circuit. In case of forced lubrication it will be necessary to precise the mounting position and localization of the holes to be provided for the connection to the lubrication circuit.

For revolutions reaching the border values indicated in the above graph it is advisable to contact our technical office in order to evaluate the modus operandi. For very low revolutions of the fast shaft (lower than 50 rpm) the phenomena which normally generate splash could not be triggered off in a correct way. We suggest contacting our technical office in order to evaluate the most suitable solution to the problem.

In case of vertical axis mounting, the upper bearings and gears could not be properly lubricated. It is therefore necessary to indicate such situation in case of order, so that suitable grease holes can be foreseen. If no indication about lubrication is given at the ordering phase, it is understood that the application conditions fall within the conditions of an horizontal mounting with splash lubrication.



Backlash

The gears connection presents a natural and necessary backlash which is transmitted to the shafts. A particular care in the assembly allows to keep such value within 15'-20'. For particular applications, where the standard backlash should be further reduced, it is possible to reach a maximum value comprised between 5'-7'. It is important to remember that an excessive backlash reduction could induce the transmission to be blocked due to the interference between the gears. Furthermore, a too tight backlash would cause friction phenomena and consequently an efficiency reduction as well as an heating of the transmission.

The gears backlash tends to increase according to the wear ratio of the components, that is why after various running cycles we can logically expect an higher value than the value taken before the start-up. Finally it should be reminded that, due to the axial components of the transmission forces, the backlash measured under load can be different than the value taken when the bevel gearbox is unloaded. In case a very high precision is requested, it is advisable to mount shrink disks, both on the output and on the input shafts, because among standard couplings it is the only one ensuring a minimum backlash for the mounting on the machine.

Installation and maintenance

INSTALLATION

When positioning the bevel gearboxes and connecting them to the machines, the greatest of care is necessary in the alignment of the axes. In case of an imprecise alignment, the bearing would be overloaded, anomalous overheated, and it would be subjected to a greater wear with a consequent lifetime reduction and a noise increase. The transmission should be mounted so that movements and vibrations are avoided, and they should be properly fixed by means of bolts. We suggest effecting a proper cleaning and lubrication of the contact surfaces before assembling the connecting members, in order that any seizure or oxidizing problems be avoided. The assembly or disassembly must be carried out using tie rods and extractors through the threaded bore at the end of the shaft. For tight fittings, a shrink assembly is recommended, heating the members to beshrunk on to 80-100°C. Thanks to their particular cubic box form, bevel gearboxes can be mounted in any position. It should be given previous notice in case of a vertical mounting in order that a proper lubrication be foreseen.

PREPARING FOR SERVICE

All speed modulation gears are supplied filled with long lasting lubricant which ensures a perfect operation of the unit according to the power values indicated in the catalogue. The only exception is represented by the ones having an "add oil" label. The lubricant filling up to the right level is an installer's responsibility and it must be carried out when the gears are not in motion. An excessive filling should be avoided in order that any overheating, noise, inner pressure loss and power loss occur.

START-UP

All the units undergo a brief testing before being delivered to the client. However, several hours of running at full load are necessary before the bevel gearbox reaches its full running efficiency. In case of need, the bevel gearbox can be immediately set to work at full load; but, circumstances permitting, it is nonetheless advisable to subject it to a gradually increasing load to reach maximum load after 20 - 30 hours of running. It is also vital to take the precautions necessary to avoid overloading in the first stages of running. The temperatures reached by the bevel gearbox in these initial phases will be higher than the ones produced after the complete running-in of the same.

ROUTINE MAINTENANCE

Bevel gearboxes must be inspected once a month. Lubricant leakage should be checked for, and in case the oil level should be restored and the seals replaced. The lubricant control must be effected when the speed modulation gear is not working. The oil should be changed at intervals which will vary according to the working conditions; generally, in normal conditions and at the normal operation temperatures, it should be possible to obtain a minimum lubricant lifetime of 10.000 hours.

STORAGE

The bevel gearboxes must be protected from deposits of dust and foreign matter during storage. Particular attention must be paid to saline or corrosive atmospheres. We also recommend to:

- Periodically rotate the shafts to ensure proper lubrication of inner parts and avoid that the seals dry up, therefore causing lubricant leakage.
- For bevel gearboxes without lubricant completely fill-in the unit with rustproof oil. When servicing for use, completely empty the oil and refill with the recommended oil to the correct level.
- Protect the shafts with suitable products.

WARRANTY

The warranty is valid only when the instructions contained in our manual are carefully followed.

Size 54 standard



RA Model



RM Model



RB Model



RX Model



RC Model



RS Model

Materials

	Material	Norms	Specs	Indications
Hollow shaft / Solid shaft	C45	EN 10083-2:2006	Carbon steel	
Hub shaft	C45	EN 10083-2:2006	Carbon steel	
Carter	GJL 250	EN 1561:2011	Grey cast iron	Completely machined on 6 faces
Bevel gears	17NiCrMo 6-4	EN 10084:2008	Casehardening alloy steel	Ground bores and planes. Gleason gears run by pair.
Lubricant	Unimec Atir SH150		Synthetic oil	0,02 lt

General features

Efficiency	90 %	Hollow shaft maximum moment	40 Nm (RA - RB - RC)
Gear backlash	15' - 20'	Solid shaft maximum moment	40 Nm (RM) - 130 Nm (RS)
Forced lubrication speed	4000 rpm	Max input speed	4500 rpm
Grease lubrication speed	100 rpm	Main Gearbox Weight	2 kg
Operating temperature	-10 °C / 80 °C	Standard Working Conditions	25 °C - regular working - 10.000 hours of expected life

Specific features

	1/1	1/1,5	Nominal Ratios 1/2	1/3	1/4
Phase between keys	+/- 8°	+/- 5°	+/- 5°	+/- 5°	+/- 5°
Inertia moment	134 kg-mm ²	50 kg-mm ²	27 kg-mm ²	16 kg-mm ²	11 kg-mm ²



Power curves

The magenta zone indicates a potential heating risk. Working cycles must be carefully analyzed.

S = Rotational speed of the fast/slow shaft [rpm]
 CL = Slow shaft torque [Nm]
 P = requested input power [kW]

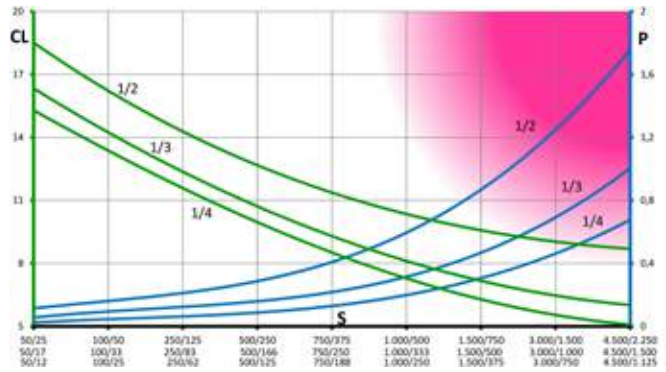
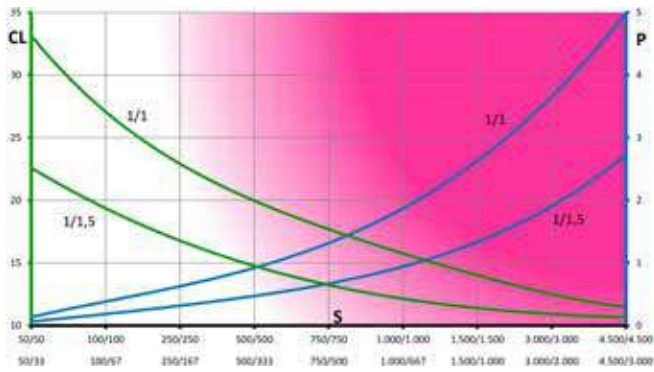

Max admissible loads

S = Fast shaft rotational speed [rpm]
 RL = Admissible radial load [kN]
 AL = Admissible axial load [kN]
 HS = Hub shaft

RHS = reinforced hub shaft
 PS = Solid protruding shaft
 HS-0 = Hub shaft static load [kN]
 PS-0 = solid shaft static load [kN]

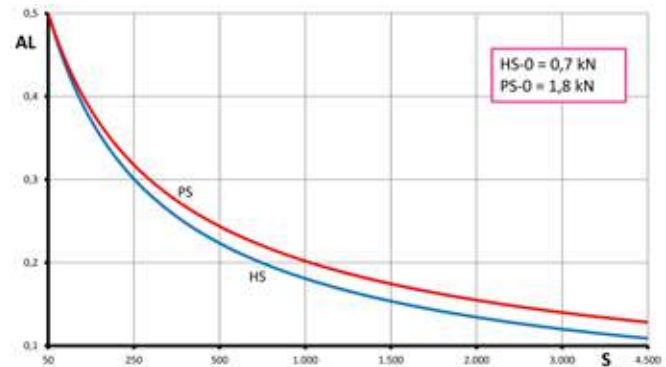
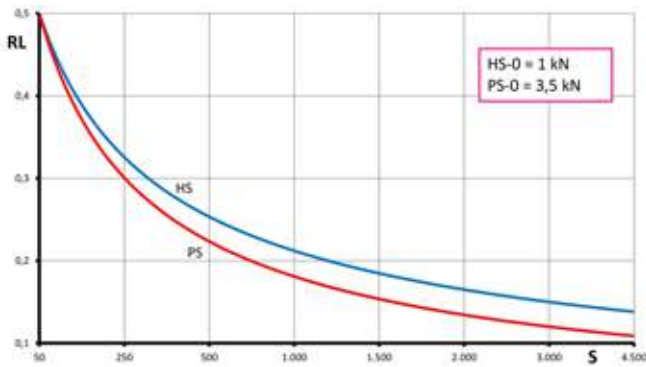

Construction Forms (1/1)

Construction Forms (1/1,5 1/2 1/3 1/4)



Form C1



Form C3



Form S1



Form C2



Form C4



Form S2



Form S3



Form S4



Form S31



Form S9



Form S10



Form S32



Size 86 standard



RA Model



RM Model



RB Model



RX Model



RC Model



RS Model

Materials

	Material	Norms	Specs	Indications
Hollow shaft / Solid shaft	C45	EN 10083-2:2006	Carbon steel	
Hub shaft	C45	EN 10083-2:2006	Carbon steel	
Carter	GJL 250	EN 1561:2011	Grey cast iron	Completely machined on 6 faces
Bevel gears	17NiCrMo 6-4	EN 10084:2008	Casehardening alloy steel	Ground bores and planes. Gleason gears run by pair.
Lubricant	Unimec Atir SH150		Synthetic oil	0,1 lt

General features

Efficiency	90 %	Hollow shaft maximum moment	90 Nm (RA - RB - RC)
Gear backlash	15' - 20'	Solid shaft maximum moment	90 Nm (RM) - 320 Nm (RS)
Forced lubrication speed	3000 rpm	Max input speed	4500 rpm
Grease lubrication speed	100 rpm	Main Gearbox Weight	6,5 kg
Operating temperature	-10 °C / 80 °C	Standard Working Conditions	25 °C - regular working - 10.000 hours of expected life

Specific features

	1/1	1/1,5	Nominal Ratios 1/2	1/3	1/4
Phase between keys	+/- 6,5°	+/- 6°	+/- 6°	+/- 6°	+/- 4,5°
Inertia moment	366 kg-mm ²	136 kg-mm ²	74 kg-mm ²	37 kg-mm ²	26 kg-mm ²

Power curves

The magenta zone indicates a potential heating risk. Working cycles must be carefully analyzed.

S = Rotational speed of the fast/slow shaft [rpm]
 CL = Slow shaft torque [Nm]
 P = requested input power [kW]

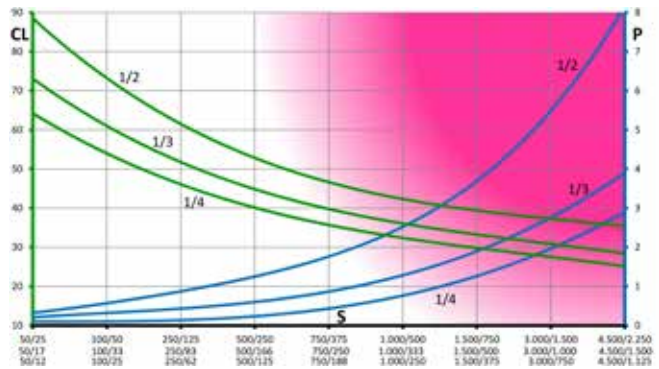
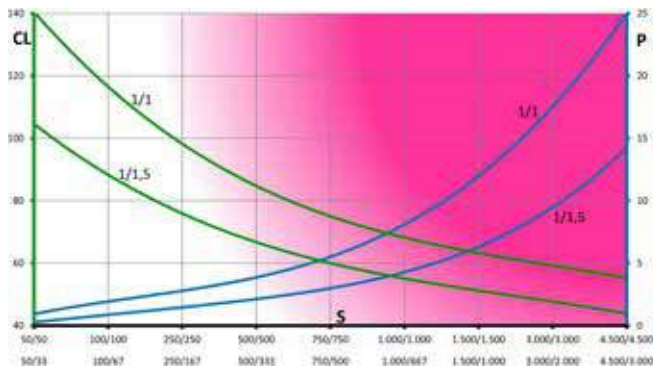



Max admissible loads

S = Fast shaft rotational speed [rpm]
 RL = Admissible radial load [kN]
 AL = Admissible axial load [kN]
 HS = Hub shaft

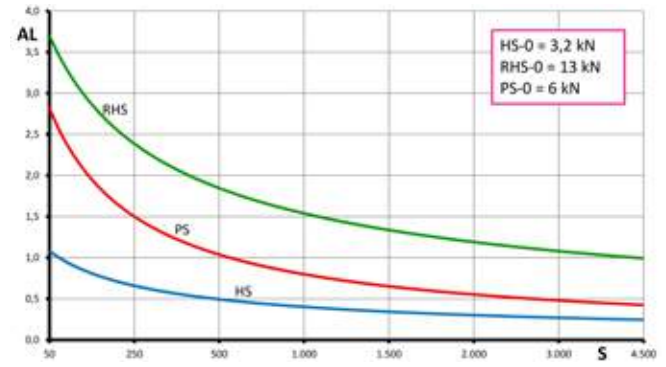
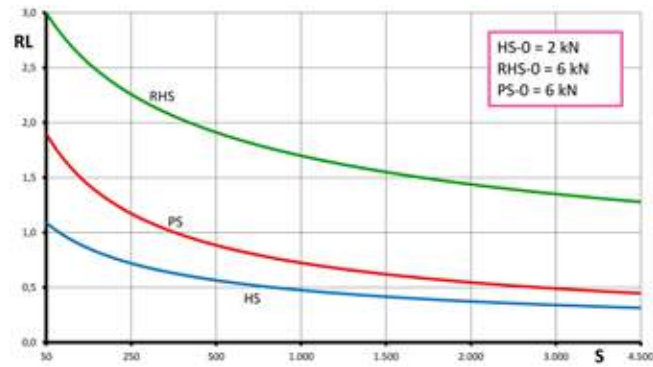
RHS = reinforced hub shaft
 PS = Solid protruding shaft
 HS-0 = Hub shaft static load [kN]
 PS-0 = solid shaft static load [kN]



Motor Models

	IEC	Worm screw bore diameter	Centering diameter	Nominal power (4 poles motor)
	IEC 63 B5	11 mm	95 mm	0,25 kW
	IEC 71 B5 / B14	14 mm	110 mm / 70 mm	0,55 kW
	IEC 80 B5 / B14	19 mm	130 mm / 80 mm	1,1 kW
	IEC 90 B5 / B14	24 mm	130 mm / 95 mm	1,9 kW

Construction Forms (1/1)

Construction Forms (1/1,5 1/2 1/3 1/4)



Size 86 - Reinforced hub shaft



RK Model



RW Model



RY Model



RZ Model



RR Model



RP Model

Materials

	Material	Norms	Specs	Indications
Hollow shaft / Solid shaft	C45	EN 10083-2:2006	Carbon steel	
Hub shaft	C45	EN 10083-2:2006	Carbon steel	
Carter	GJL 250	EN 1561:2011	Grey cast iron	Completely machined on 6 faces
Bevel gears	17NiCrMo 6-4	EN 10084:2008	Casehardening alloy steel	Ground bores and planes. Gleason gears run by pair.
Lubricant	Unimec Atir SH150		Synthetic oil	0,1 lt

General features

Efficiency	90 %	Hollow shaft maximum moment	90 Nm (RK - RY - RR)
Gear backlash	15' - 20'	Solid shaft maximum moment	90 Nm (RW) - 320 Nm (RP)
Forced lubrication speed	3000 rpm	Max input speed	4500 rpm
Grease lubrication speed	100 rpm	Main Gearbox Weight	6,5 kg
Operating temperature	-10 °C / 80 °C	Standard Working Conditions	25 °C - regular working - 10.000 hours of expected life

Specific features

	1/1	1/1,5	Nominal Ratios 1/2	1/3	1/4
Phase between keys	+/- 6,5°	+/- 6°	+/- 6°	+/- 6°	+/- 4,5°
Inertia moment	366 kg-mm ²	136 kg-mm ²	74 kg-mm ²	37 kg-mm ²	26 kg-mm ²



Power curves

The magenta zone indicates a potential heating risk. Working cycles must be carefully analyzed.

S = Rotational speed of the fast/slow shaft [rpm]
 CL = Slow shaft torque [Nm]
 P = requested input power [kW]

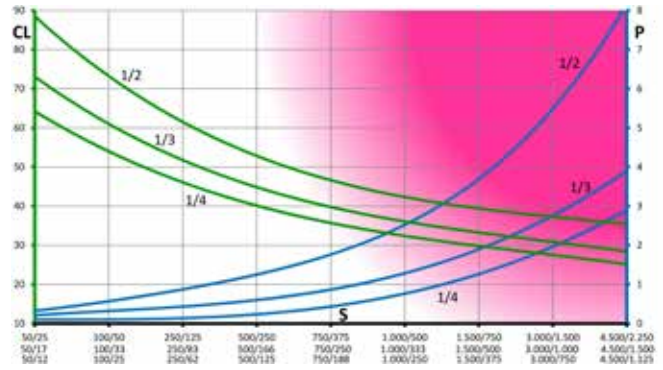
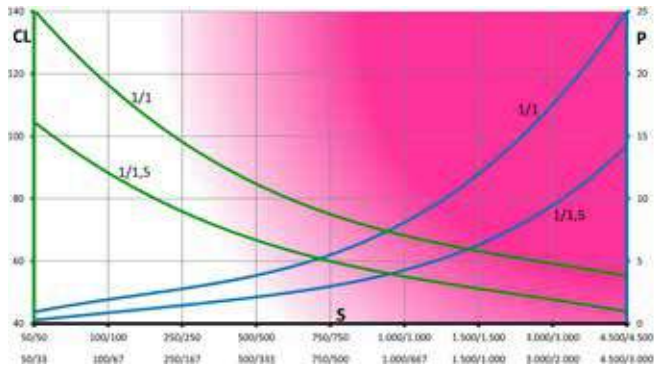

Max admissible loads

S = Fast shaft rotational speed [rpm]
 RL = Admissible radial load [kN]
 AL = Admissible axial load [kN]
 HS = Hub shaft

RHS = reinforced hub shaft
 PS = Solid protruding shaft
 HS-0 = Hub shaft static load [kN]
 PS-0 = solid shaft static load [kN]

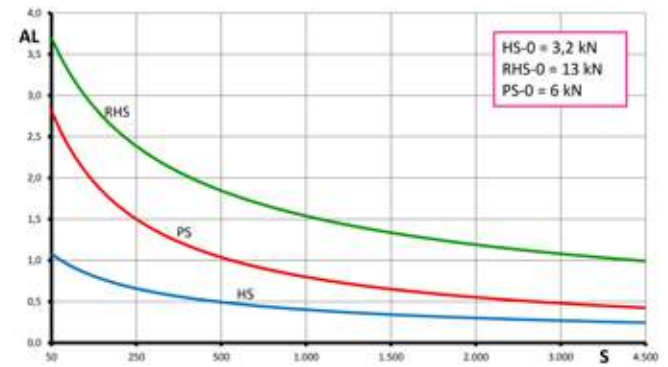
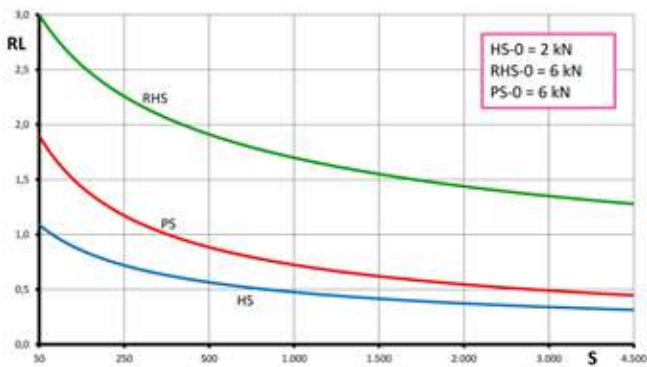

Construction Forms (1/1)

Construction Forms (1/1,5 1/2 1/3 1/4)



Form C1



Form C3



Form S1



Form C2



Form C4



Form S2



Form S3



Form S4



Form S31



Form S9



Form S10



Form S32



Size 110 standard



RA Model



RM Model



RB Model



RX Model



RC Model



RS Model

Materials

	Material	Norms	Specs	Indications
Hollow shaft / Solid shaft	C45	EN 10083-2:2006	Carbon steel	
Hub shaft	C45	EN 10083-2:2006	Carbon steel	
Carter	GJL 250	EN 1561:2011	Grey cast iron	Completely machined on 6 faces
Bevel gears	17NiCrMo 6-4	EN 10084:2008	Casehardening alloy steel	Ground bores and planes. Gleason gears run by pair.
Lubricant	Unimec Atir SH150		Synthetic oil	0,2 lt

General features

Efficiency	90 %	Hollow shaft maximum moment	180 Nm (RA - RB - RC)
Gear backlash	15' - 20'	Solid shaft maximum moment	180 Nm (RM) - 410 Nm (RS)
Forced lubrication speed	2500 rpm	Max input speed	3000 rpm
Grease lubrication speed	100 rpm	Main Gearbox Weight	10 kg
Operating temperature	-10 °C / 80 °C	Standard Working Conditions	25 °C - regular working - 10.000 hours of expected life

Specific features

	1/1	1/1,5	Nominal Ratios 1/2	1/3	1/4
Phase between keys	+/- 5,5°	+/- 5,5°	+/- 6°	+/- 4,5°	+/- 4,5°
Inertia moment	798 kg-mm ²	300 kg-mm ²	168 kg-mm ²	89 kg-mm ²	63 kg-mm ²



Power curves

The magenta zone indicates a potential heating risk. Working cycles must be carefully analyzed.

S = Rotational speed of the fast/slow shaft [rpm]
 CL = Slow shaft torque [Nm]
 P = requested input power [kW]

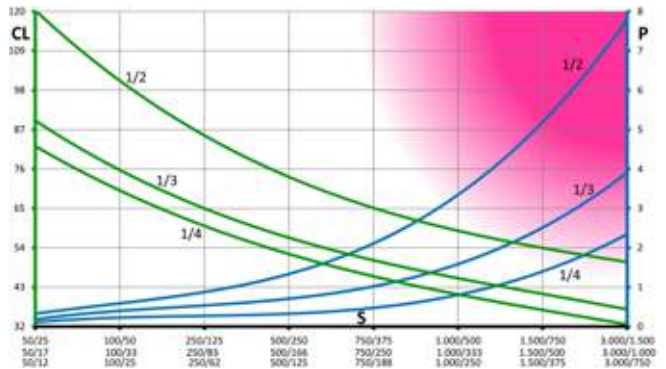
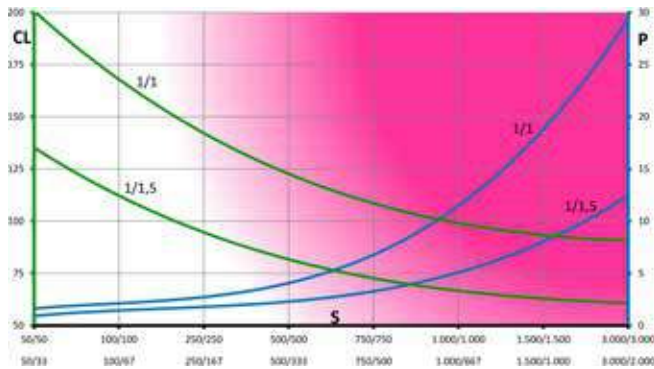

Max admissible loads

S = Fast shaft rotational speed [rpm]
 RL = Admissible radial load [kN]
 AL = Admissible axial load [kN]
 HS = Hub shaft

RHS = reinforced hub shaft
 PS = Solid protruding shaft
 HS-0 = Hub shaft static load [kN]
 PS-0 = solid shaft static load [kN]

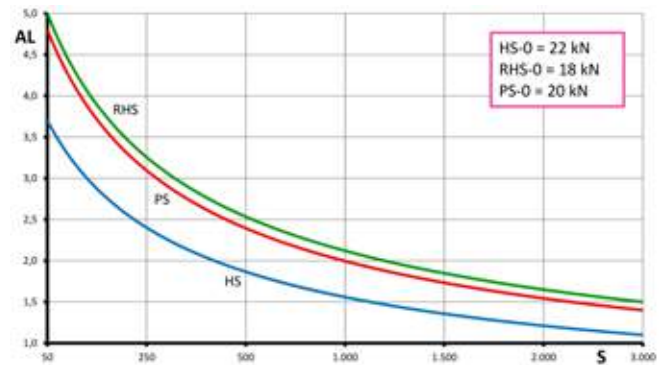
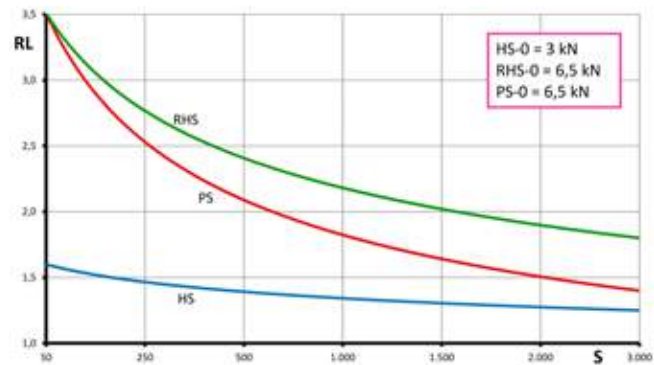

Motor Models

	IEC	Worm screw bore diameter	Centering diameter	Nominal power (4 poles motor)
	IEC 80 B5 / B14	19 mm	130 mm / 80 mm	1,1 kW
	IEC 90 B5 / B14	24 mm	130 mm / 95 mm	1,9 kW

Construction Forms (1/1)

Construction Forms (1/1,5 1/2 1/3 1/4)



Size 110 - Reinforced hub shaft



RK Model



RW Model



RY Model



RZ Model



RR Model



RP Model

Materials

	Material	Norms	Specs	Indications
Hollow shaft / Solid shaft	C45	EN 10083-2:2006	Carbon steel	
Hub shaft	C45	EN 10083-2:2006	Carbon steel	
Carter	GJL 250	EN 1561:2011	Grey cast iron	Completely machined on 6 faces
Bevel gears	17NiCrMo 6-4	EN 10084:2008	Casehardening alloy steel	Ground bores and planes. Gleason gears run by pair.
Lubricant	Unimec Atir SH150		Synthetic oil	0,2 lt

General features

Efficiency	90 %	Hollow shaft maximum moment	180 Nm (RK - RY - RR)
Gear backlash	15' - 20'	Solid shaft maximum moment	180 Nm (RW) - 410 Nm (RP)
Forced lubrication speed	2500 rpm	Max input speed	3000 rpm
Grease lubrication speed	100 rpm	Main Gearbox Weight	10 kg
Operating temperature	-10 °C / 80 °C	Standard Working Conditions	25 °C - regular working - 10.000 hours of expected life

Specific features

	1/1	1/1,5	Nominal Ratios 1/2	1/3	1/4
Phase between keys	+/- 5,5°	+/- 5,5°	+/- 6°	+/- 4,5°	+/- 4,5°
Inertia moment	798 kg-mm ²	300 kg-mm ²	168 kg-mm ²	89 kg-mm ²	63 kg-mm ²

Power curves

The magenta zone indicates a potential heating risk. Working cycles must be carefully analyzed.

S = Rotational speed of the fast/slow shaft [rpm]
 CL = Slow shaft torque [Nm]
 P = requested input power [kW]

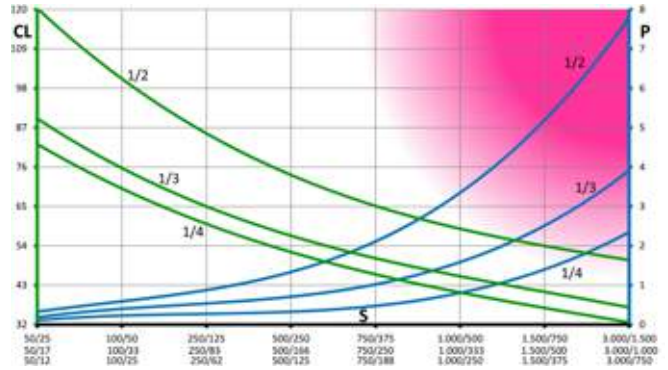
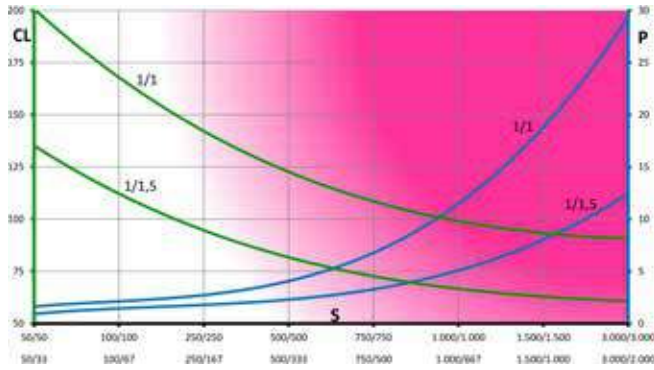

Max admissible loads

S = Fast shaft rotational speed [rpm]
 RL = Admissible radial load [kN]
 AL = Admissible axial load [kN]
 HS = Hub shaft

RHS = reinforced hub shaft
 PS = Solid protruding shaft
 HS-0 = Hub shaft static load [kN]
 PS-0 = solid shaft static load [kN]

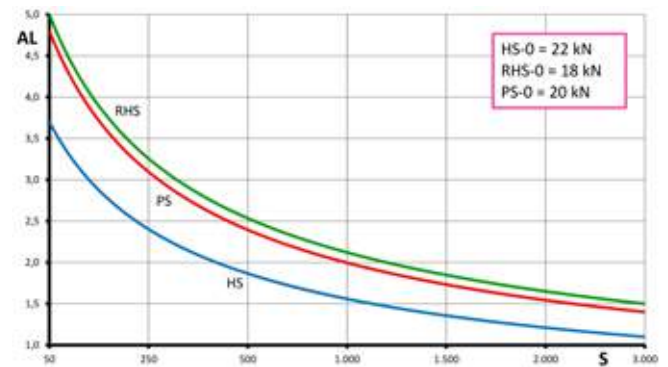
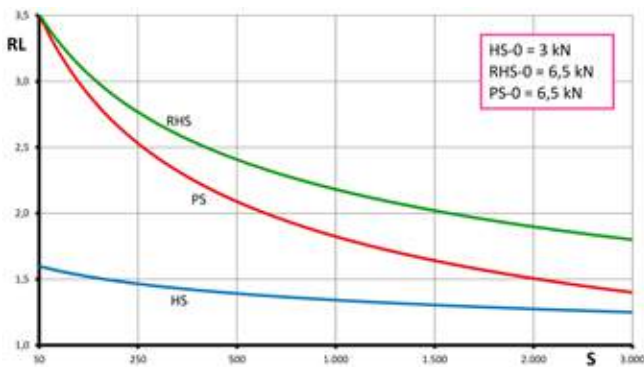

Construction Forms (1/1)

Construction Forms (1/1,5 1/2 1/3 1/4)



Form C1



Form C3



Form S1



Form C2



Form C4



Form S2



Form S3



Form S4



Form S31



Form S9



Form S10



Form S32



Size 134 standard



RA Model



RM Model



RB Model

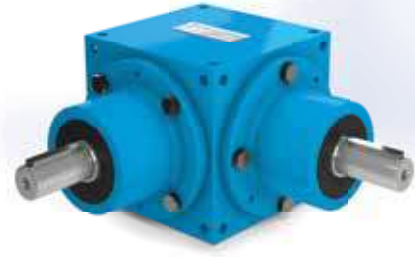

RX Model



RC Model



RS Model

› Materials

	Material	Norms	Specs	Indications
Hollow shaft / Solid shaft	C45	EN 10083-2:2006	Carbon steel	
Hub shaft	C45	EN 10083-2:2006	Carbon steel	
Carter	GJL 250	EN 1561:2011	Grey cast iron	Completely machined on 6 faces
Bevel gears	17NiCrMo 6-4	EN 10084:2008	Casehardening alloy steel	Ground bores and planes. Gleason gears run by pair.
Lubricant	Unimec Atir SH150		Synthetic oil	0,4 lt

› General features

Efficiency	90 %	Hollow shaft maximum moment	320 Nm (RA - RB - RC)
Gear backlash	15' - 20'	Solid shaft maximum moment	320 Nm (RM) - 770 Nm (RS)
Forced lubrication speed	2000 rpm	Max input speed	2500 rpm
Grease lubrication speed	100 rpm	Main Gearbox Weight	19 kg
Operating temperature	-10 °C / 80 °C	Standard Working Conditions	25 °C - regular working - 10.000 hours of expected life

› Specific features

	1/1	1/1,5	Nominal Ratios 1/2	1/3	1/4
Phase between keys	+/- 6,5°	+/- 5,5°	+/- 6,5°	+/- 5,5°	+/- 4,5°
Inertia moment	2590 kg-mm ²	950 kg-mm ²	535 kg-mm ²	284 kg-mm ²	207 kg-mm ²



Power curves

La zona magenta indica un potenziale rischio di accumulo di calore. I cicli di lavoro devono essere analizzati con cura.

S = Rotational speed of the fast/slow shaft [rpm]
 CL = Slow shaft torque [Nm]
 P = requested input power [kW]

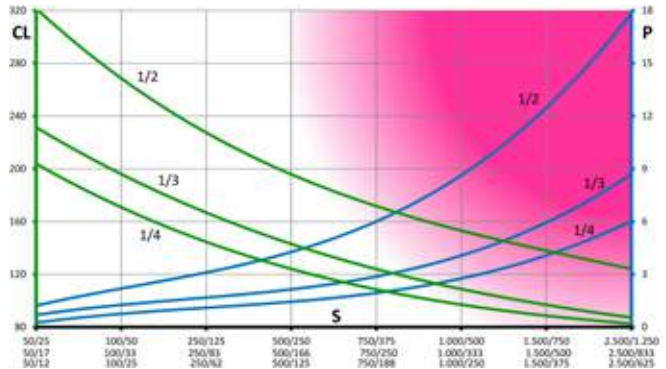
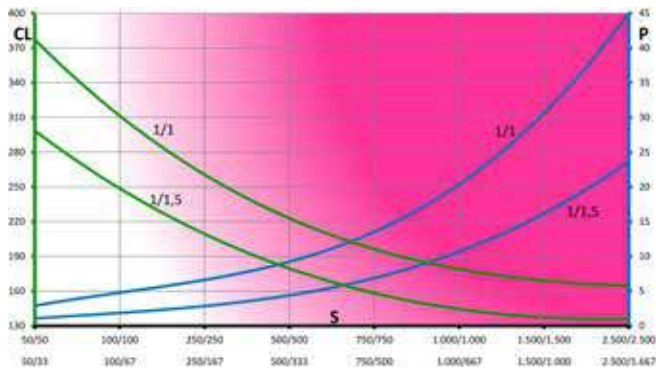

Max admissible loads

S = Fast shaft rotational speed [rpm]
 RL = Admissible radial load [kN]
 AL = Admissible axial load [kN]
 HS = Hub shaft

RHS = reinforced hub shaft
 PS = Solid protruding shaft
 HS-0 = Hub shaft static load [kN]
 PS-0 = solid shaft static load [kN]

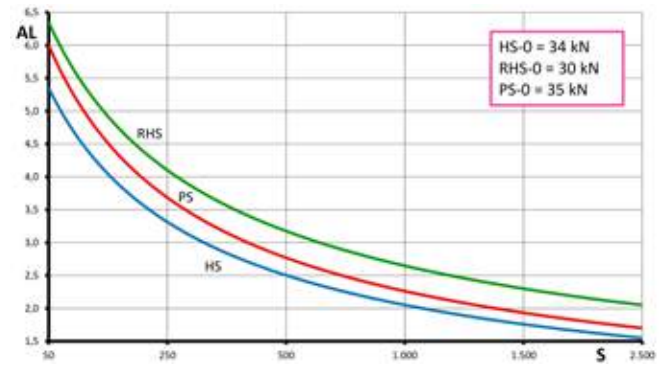
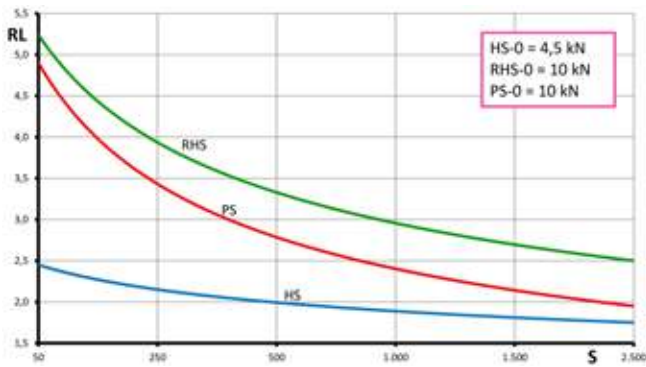

Motor Models

	IEC	Worm screw bore diameter	Centering diameter	Nominal power (4 poles motor)
	IEC 80 B5 / B14	19 mm	130 mm / 80 mm	1,1 kW
	IEC 90 B5 / B14	24 mm	130 mm / 95 mm	1,9 kW
	IEC 100-112 B5 / B14	28 mm	180 mm / 110 mm	5 kW
	IEC 132 B5 / B14	38 mm	230 mm / 130 mm	11 kW

Construction Forms (1/1)

Construction Forms (1/1,5 1/2 1/3 1/4)



Size 134 - Reinforced hub shaft



RK Model



RW Model



RY Model



RZ Model



RR Model



RP Model

Materials

	Material	Norms	Specs	Indications
Hollow shaft / Solid shaft	C45	EN 10083-2:2006	Carbon steel	
Hub shaft	C45	EN 10083-2:2006	Carbon steel	
Carter	GJL 250	EN 1561:2011	Grey cast iron	Completely machined on 6 faces
Bevel gears	17NiCrMo 6-4	EN 10084:2008	Casehardening alloy steel	Ground bores and planes. Gleason gears run by pair.
Lubricant	Unimec Atir SH150		Synthetic oil	0,4 lt

General features

Efficiency	90 %	Hollow shaft maximum moment	320 Nm (RK - RY - RR)
Gear backlash	15' - 20'	Solid shaft maximum moment	320 Nm (RW) - 770 Nm (RP)
Forced lubrication speed	2000 rpm	Max input speed	2500 rpm
Grease lubrication speed	100 rpm	Main Gearbox Weight	19 kg
Operating temperature	-10 °C / 80 °C	Standard Working Conditions	25 °C - regular working - 10.000 hours of expected life

Specific features

	1/1	1/1,5	Nominal Ratios 1/2	1/3	1/4
Phase between keys	+/- 6,5°	+/- 5,5°	+/- 6,5°	+/- 5,5°	+/- 4,5°
Inertia moment	2590 kg-mm ²	950 kg-mm ²	535 kg-mm ²	284 kg-mm ²	207 kg-mm ²



Power curves

La zona magenta indica un potenziale rischio di accumulo di calore. I cicli di lavoro devono essere analizzati con cura.

S = Rotational speed of the fast/slow shaft [rpm]
 CL = Slow shaft torque [Nm]
 P = requested input power [kW]

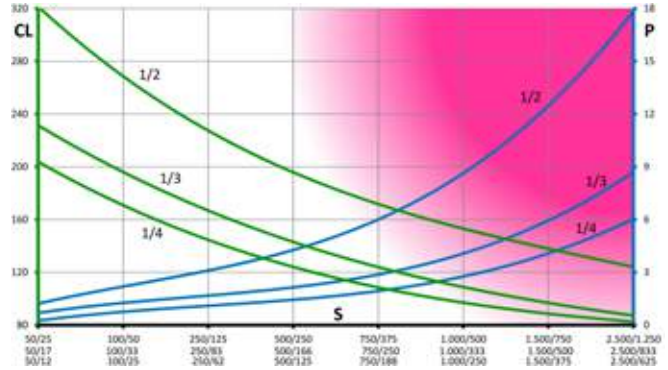
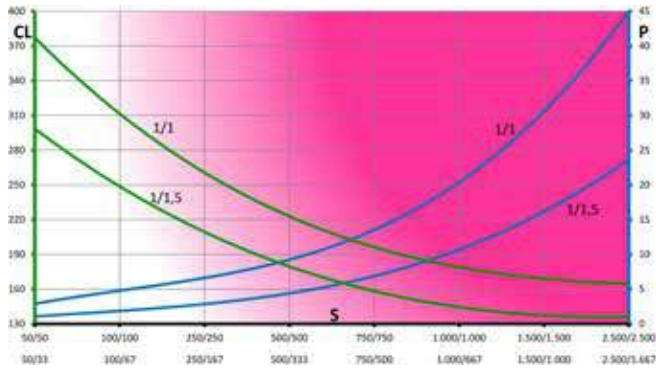

Max admissible loads

S = Fast shaft rotational speed [rpm]
 RL = Admissible radial load [kN]
 AL = Admissible axial load [kN]
 HS = Hub shaft

RHS = reinforced hub shaft
 PS = Solid protruding shaft
 HS-0 = Hub shaft static load [kN]
 PS-0 = solid shaft static load [kN]

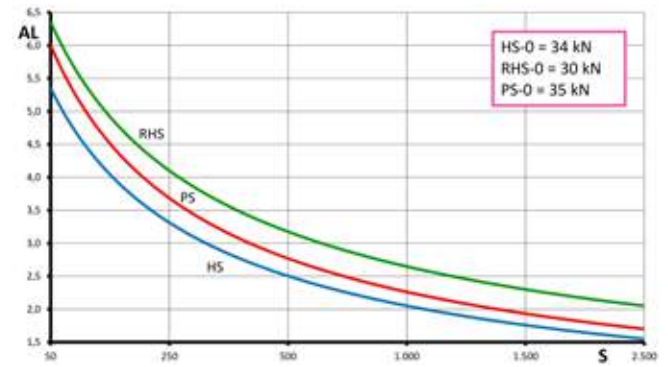
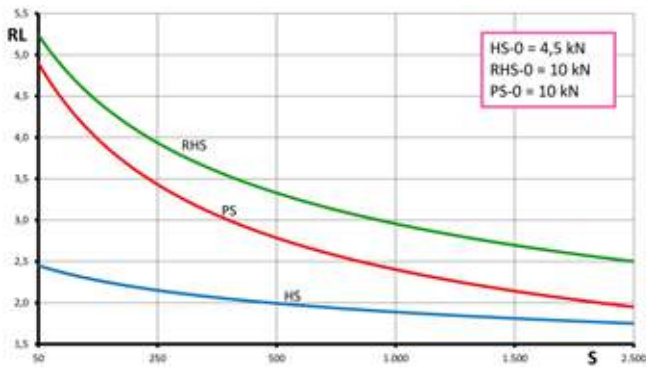

Construction Forms (1/1)

Construction Forms (1/1,5 1/2 1/3 1/4)



Form C1



Form C3



Form S1



Form C2



Form C4



Form S2



Form S3



Form S4



Form S31



Form S9



Form S10



Form S32



Size 166 standard



RA Model



RM Model



RB Model



RX Model



RC Model

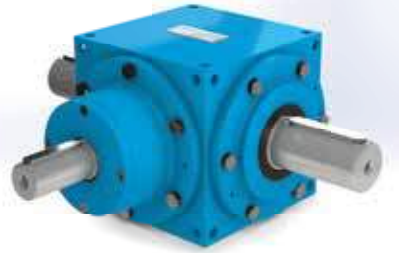

RS Model

Materials

	Material	Norms	Specs	Indications
Hollow shaft / Solid shaft	C45	EN 10083-2:2006	Carbon steel	
Hub shaft	C45	EN 10083-2:2006	Carbon steel	
Carter	GJL 250	EN 1561:2011	Grey cast iron	Completely machined on 6 faces
Bevel gears	17NiCrMo 6-4	EN 10084:2008	Casehardening alloy steel	Ground bores and planes. Gleason gears run by pair.
Lubricant	Unimec Atir SH150		Synthetic oil	0,9 lt

General features

Efficiency	90 %	Hollow shaft maximum moment	770 Nm (RA - RB - RC)
Gear backlash	15' - 20'	Solid shaft maximum moment	770 Nm (RM) - 2140 Nm (RS)
Forced lubrication speed	1500 rpm	Max input speed	1800 rpm
Grease lubrication speed	100 rpm	Main Gearbox Weight	32 kg
Operating temperature	-10 °C / 80 °C	Standard Working Conditions	25 °C - regular working - 10.000 hours of expected life

Specific features

	1/1	1/1,5	Nominal Ratios 1/2	1/3	1/4
Phase between keys	+/- 6,5°	+/- 6°	+/- 6,5°	+/- 5°	+/- 4°
Inertia moment	11170 kg-mm ²	3970 kg-mm ²	2130 kg-mm ²	1013 kg-mm ²	670 kg-mm ²



Power curves

La zona magenta indica un potenziale rischio di accumulo di calore. I cicli di lavoro devono essere analizzati con cura.

S = Rotational speed of the fast/slow shaft [rpm]
 CL = Slow shaft torque [Nm]
 P = requested input power [kW]

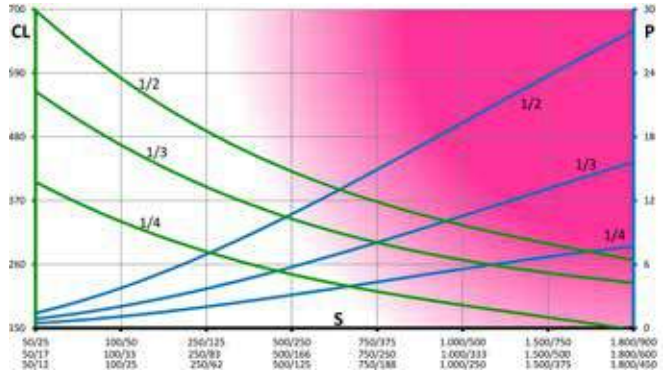
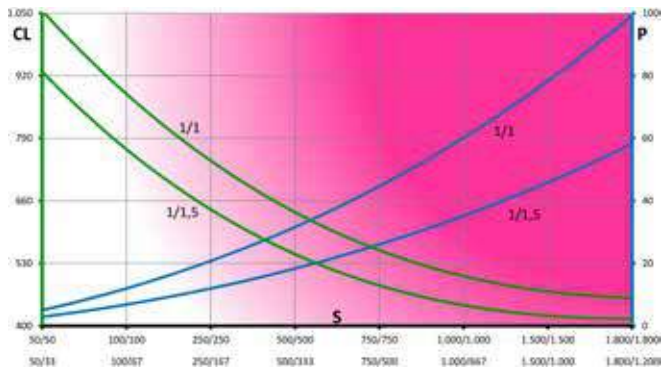



Max admissible loads

S = Fast shaft rotational speed [rpm]
 RL = Admissible radial load [kN]
 AL = Admissible axial load [kN]
 HS = Hub shaft

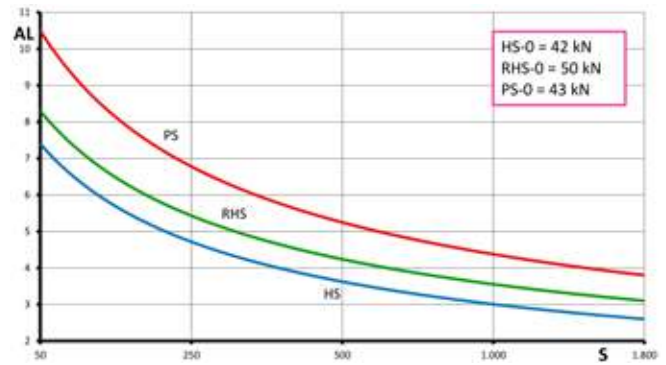
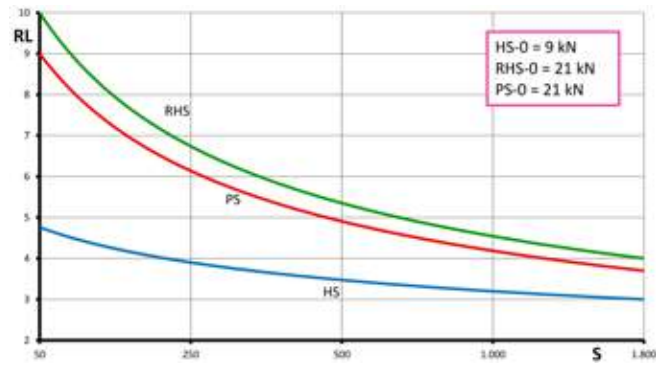
RHS = reinforced hub shaft
 PS = Solid protruding shaft
 HS-0 = Hub shaft static load [kN]
 PS-0 = solid shaft static load [kN]



Motor Models

	IEC	Worm screw bore diameter	Centering diameter	Nominal power (4 poles motor)
	IEC 90 B5 / B14	24 mm	130 mm / 95 mm	1,9 kW
	IEC 100-112 B5 / B14	28 mm	180 mm / 110 mm	5 kW
	IEC 132 B5 / B14	38 mm	230 mm / 130 mm	11 kW
	IEC 160 B5 / B14	42 mm	250 mm / 180 mm	15 kW
	IEC 180 B5	48 mm	250 mm	22 kW

Construction Forms (1/1)

Construction Forms (1/1,5 1/2 1/3 1/4)



Size 166 - Reinforced hub shaft



RK Model



RW Model



RY Model

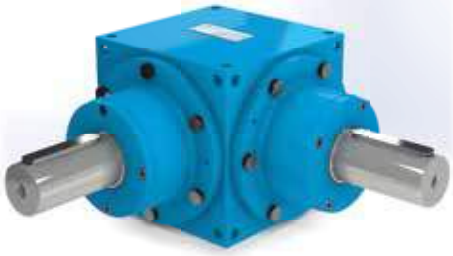

RZ Model



RR Model



RP Model

Materials

	Material	Norms	Specs	Indications
Hollow shaft / Solid shaft	C45	EN 10083-2:2006	Carbon steel	
Hub shaft	C45	EN 10083-2:2006	Carbon steel	
Carter	GJL 250	EN 1561:2011	Grey cast iron	Completely machined on 6 faces
Bevel gears	17NiCrMo 6-4	EN 10084:2008	Casehardening alloy steel	Ground bores and planes. Gleason gears run by pair.
Lubricant	Unimec Atir SH150		Synthetic oil	0,9 lt

General features

Efficiency	90 %	Hollow shaft maximum moment	770 Nm (RK - RY - RR)
Gear backlash	15' - 20'	Solid shaft maximum moment	770 Nm (RW) - 2140 Nm (RP)
Forced lubrication speed	1500 rpm	Max input speed	1800 rpm
Grease lubrication speed	100 rpm	Main Gearbox Weight	32 kg
Operating temperature	-10 °C / 80 °C	Standard Working Conditions	25 °C - regular working - 10.000 hours of expected life

Specific features

	1/1	1/1,5	Nominal Ratios 1/2	1/3	1/4
Phase between keys	+/- 6,5°	+/- 6°	+/- 6,5°	+/- 5°	+/- 4°
Inertia moment	11170 kg-mm ²	3970 kg-mm ²	2130 kg-mm ²	1013 kg-mm ²	670 kg-mm ²



Power curves

La zona magenta indica un potenziale rischio di accumulo di calore. I cicli di lavoro devono essere analizzati con cura.

S = Rotational speed of the fast/slow shaft [rpm]
 CL = Slow shaft torque [Nm]
 P = requested input power [kW]

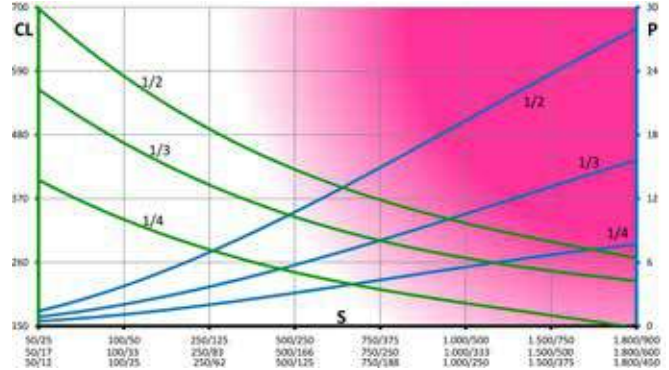
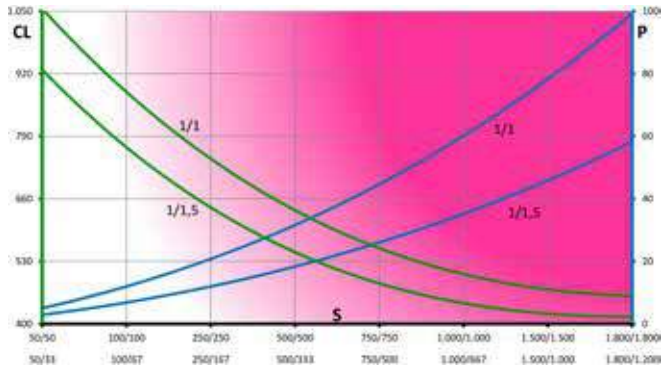

Max admissible loads

S = Fast shaft rotational speed [rpm]
 RL = Admissible radial load [kN]
 AL = Admissible axial load [kN]
 HS = Hub shaft

RHS = reinforced hub shaft
 PS = Solid protruding shaft
 HS-0 = Hub shaft static load [kN]
 PS-0 = solid shaft static load [kN]

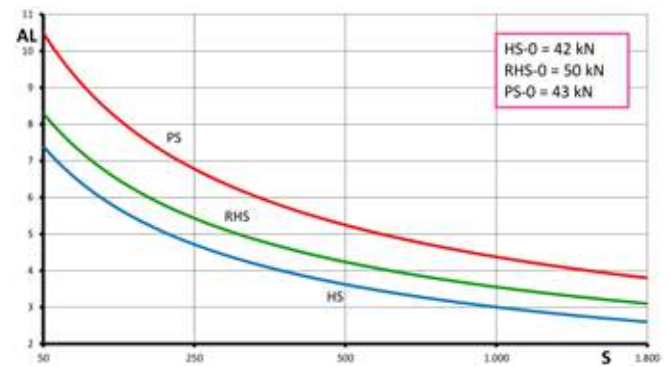
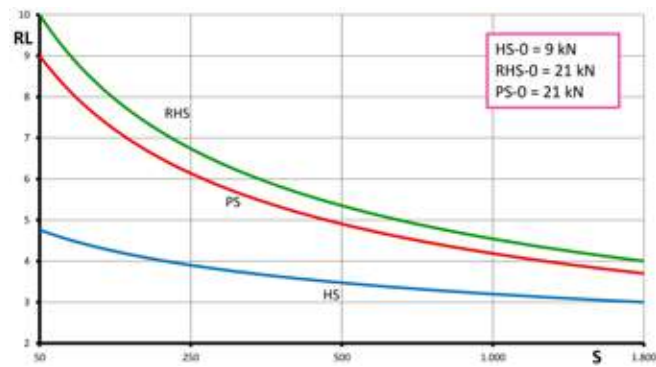

Construction Forms (1/1)

Construction Forms (1/1,5 1/2 1/3 1/4)



Form C1



Form C3



Form S1



Form C2



Form C4



Form S2



Form S3



Form S4



Form S31



Form S9



Form S10



Form S32



Size 200 standard



RA Model



RM Model



RB Model



RX Model



RC Model



RS Model

Materials

	Material	Norms	Specs	Indications
Hollow shaft / Solid shaft	C45	EN 10083-2:2006	Carbon steel	
Hub shaft	C45	EN 10083-2:2006	Carbon steel	
Carter	GJL 250	EN 1561:2011	Grey cast iron	Completely machined on 6 faces
Bevel gears	17NiCrMo 6-4	EN 10084:2008	Casehardening alloy steel	Ground bores and planes. Gleason gears run by pair.
Lubricant	Unimec Atir SH150		Synthetic oil	1,5 lt

General features

Efficiency	90 %	Hollow shaft maximum moment	1740 Nm (RA - RB - RC)
Gear backlash	15' - 20'	Solid shaft maximum moment	1740 Nm (RM) - 3900 Nm (RS)
Forced lubrication speed	1000 rpm	Max input speed	1500 rpm
Grease lubrication speed	100 rpm	Main Gearbox Weight	55 kg
Operating temperature	-10 °C / 80 °C	Standard Working Conditions	25 °C - regular working - 10.000 hours of expected life

Specific features

	1/1	1/1,5	Nominal Ratios 1/2	1/3	1/4
Phase between keys	+/- 6,5°	+/- 5,5°	+/- 6,5°	+/- 5°	+/- 4°
Inertia moment	0,2625 kg·m ²	10000 kg·mm ²	5276 kg·mm ²	2670 kg·mm ²	1715 kg·mm ²



Power curves

La zona magenta indica un potenziale rischio di accumulo di calore. I cicli di lavoro devono essere analizzati con cura.

S = Rotational speed of the fast/slow shaft [rpm]
 CL = Slow shaft torque [Nm]
 P = requested input power [kW]

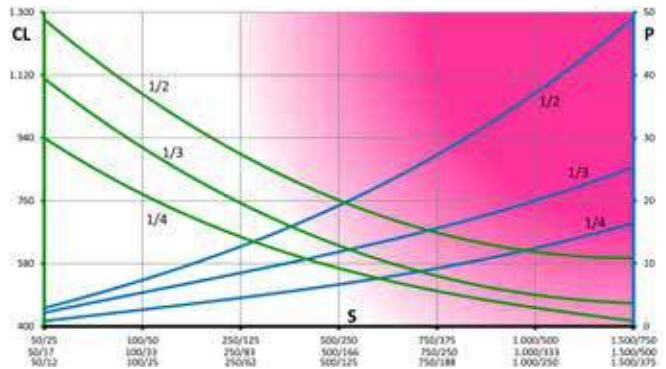
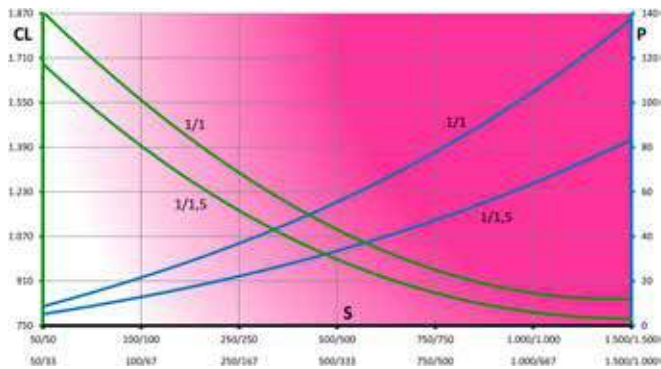



Max admissible loads

S = Fast shaft rotational speed [rpm]
 RL = Admissible radial load [kN]
 AL = Admissible axial load [kN]
 HS = Hub shaft

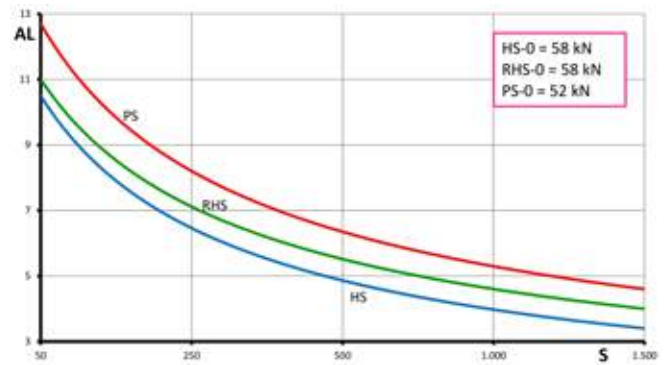
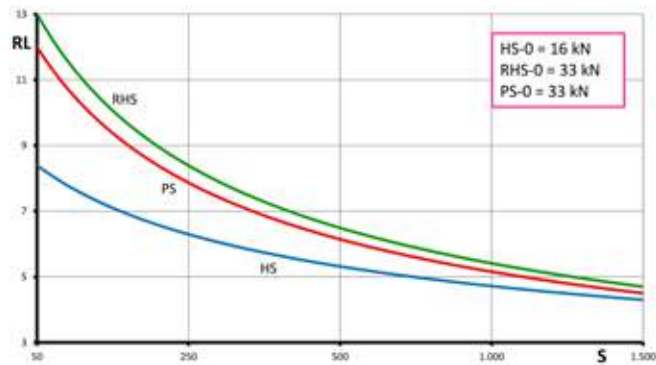
RHS = reinforced hub shaft
 PS = Solid protruding shaft
 HS-0 = Hub shaft static load [kN]
 PS-0 = solid shaft static load [kN]



Motor Models

	IEC	Worm screw bore diameter	Centering diameter	Nominal power (4 poles motor)
	IEC 132 B5 / B14	38 mm	230 mm / 130 mm	9,2 kW
	IEC 160 B5 / B14	42 mm	250 mm / 180 mm	15 kW
	IEC 180 B5	48 mm	250 mm	22 kW

Construction Forms (1/1)

Construction Forms (1/1,5 1/2 1/3 1/4)



Size 200 - Reinforced hub shaft



RK Model



RW Model



RY Model

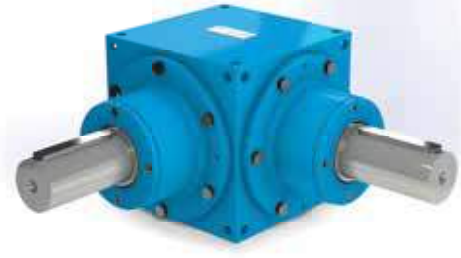

RZ Model



RR Model



RP Model

Materials

	Material	Norms	Specs	Indications
Hollow shaft / Solid shaft	C45	EN 10083-2:2006	Carbon steel	
Hub shaft	C45	EN 10083-2:2006	Carbon steel	
Carter	GJL 250	EN 1561:2011	Grey cast iron	Completely machined on 6 faces
Bevel gears	17NiCrMo 6-4	EN 10084:2008	Casehardening alloy steel	Ground bores and planes. Gleason gears run by pair.
Lubricant	Unimec Atir SH150		Synthetic oil	1,5 lt

General features

Efficiency	90 %	Hollow shaft maximum moment	1740 Nm (RK - RY - RR)
Gear backlash	15' - 20'	Solid shaft maximum moment	1740 Nm (RW) - 3900 Nm (RP)
Forced lubrication speed	1000 rpm	Max input speed	1500 rpm
Grease lubrication speed	100 rpm	Main Gearbox Weight	55 kg
Operating temperature	-10 °C / 80 °C	Standard Working Conditions	25 °C - regular working - 10.000 hours of expected life

Specific features

	1/1	1/1,5	Nominal Ratios 1/2	1/3	1/4
Phase between keys	+/- 6,5°	+/- 5,5°	+/- 6,5°	+/- 5°	+/- 4°
Inertia moment	0,2625 kg-m ²	10000 kg-mm ²	5276 kg-mm ²	2670 kg-mm ²	1715 kg-mm ²

Power curves

La zona magenta indica un potenziale rischio di accumulo di calore. I cicli di lavoro devono essere analizzati con cura.

S = Rotational speed of the fast/slow shaft [rpm]
 CL = Slow shaft torque [Nm]
 P = requested input power [kW]

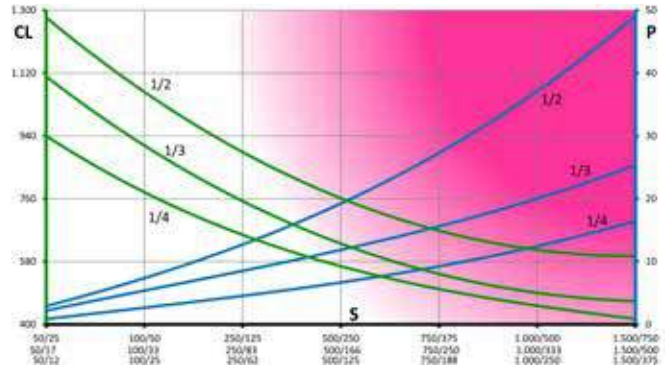
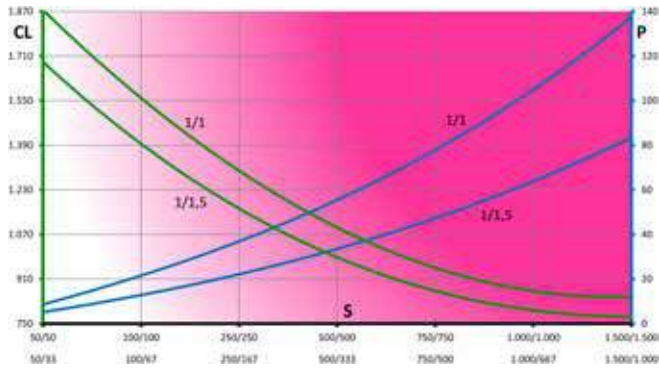

Max admissible loads

S = Fast shaft rotational speed [rpm]
 RL = Admissible radial load [kN]
 AL = Admissible axial load [kN]
 HS = Hub shaft

RHS = reinforced hub shaft
 PS = Solid protruding shaft
 HS-0 = Hub shaft static load [kN]
 PS-0 = solid shaft static load [kN]

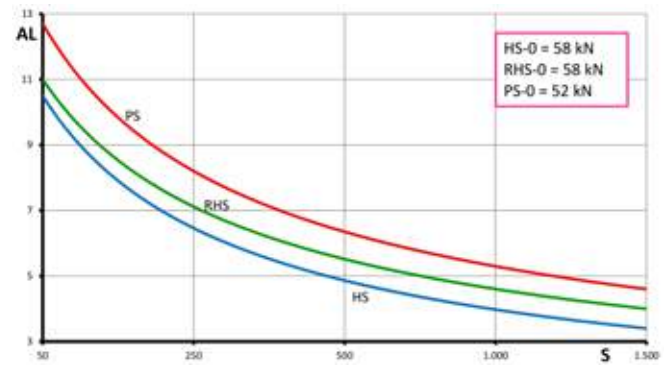
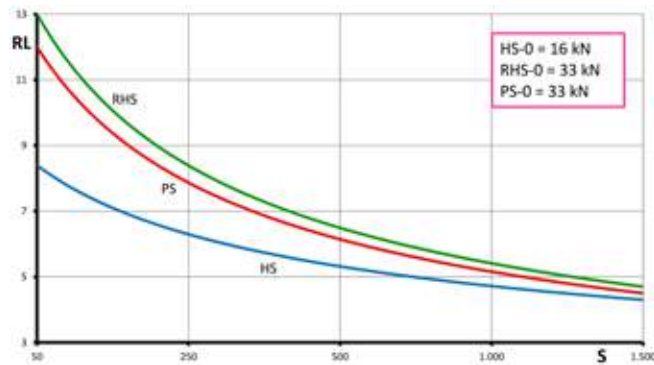

Construction Forms (1/1)

Construction Forms (1/1,5 1/2 1/3 1/4)



Form C1



Form C3



Form S1



Form C2



Form C4



Form S2



Form S3



Form S4



Form S31



Form S9



Form S10



Form S32



Size 250 standard



RA Model



RM Model



RB Model



RX Model



RC Model

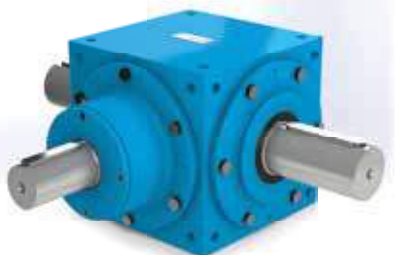

RS Model

Materials

	Material	Norms	Specs	Indications
Hollow shaft / Solid shaft	C45	EN 10083-2:2006	Carbon steel	
Hub shaft	C45	EN 10083-2:2006	Carbon steel	
Carter	GJL 250	EN 1561:2011	Grey cast iron	Completely machined on 6 faces
Bevel gears	17NiCrMo 6-4	EN 10084:2008	Casehardening alloy steel	Ground bores and planes. Gleason gears run by pair.
Lubricant	Unimec Atir SH150		Synthetic oil	3,1 lt

General features

Efficiency	90 %	Hollow shaft maximum moment	3900 Nm (RA - RB - RC)
Gear backlash	15' - 20'	Solid shaft maximum moment	3900 Nm (RM) - 8000 Nm (RS)
Forced lubrication speed	800 rpm	Max input speed	1000 rpm
Grease lubrication speed	100 rpm	Main Gearbox Weight	105 kg
Operating temperature	-10 °C / 80 °C	Standard Working Conditions	25 °C - regular working - 10.000 hours of expected life

Specific features

	1/1	1/1,5	Nominal Ratios 1/2	1/3	1/4
Phase between keys	+/- 6°	+/- 5,5°	+/- 6°	+/- 5°	+/- 4,5°
Inertia moment	0,0915 kg-m ²	0,0328 kg-m ²	0,0177 kg-m ²	8670 kg-mm ²	5830 kg-mm ²



Power curves

La zona magenta indica un potenziale rischio di accumulo di calore. I cicli di lavoro devono essere analizzati con cura.

S = Rotational speed of the fast/slow shaft [rpm]
CL = Slow shaft torque [Nm]
P = requested input power [kW]

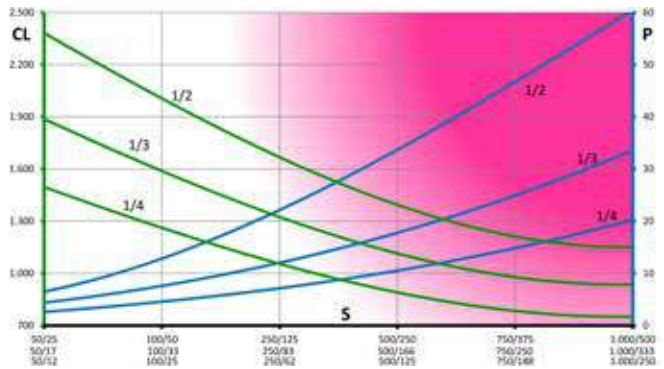
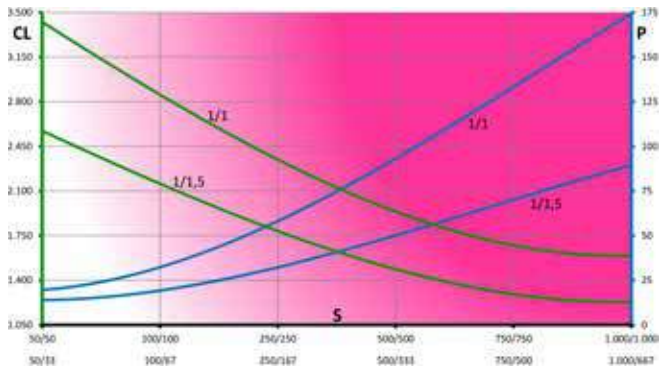



Max admissible loads

S = Fast shaft rotational speed [rpm]
RL = Admissible radial load [kN]
AL = Admissible axial load [kN]
HS = Hub shaft

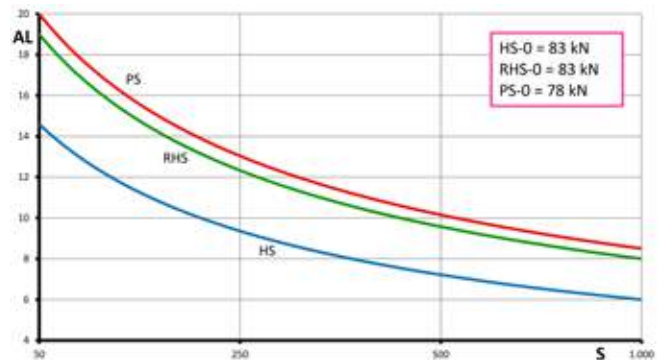
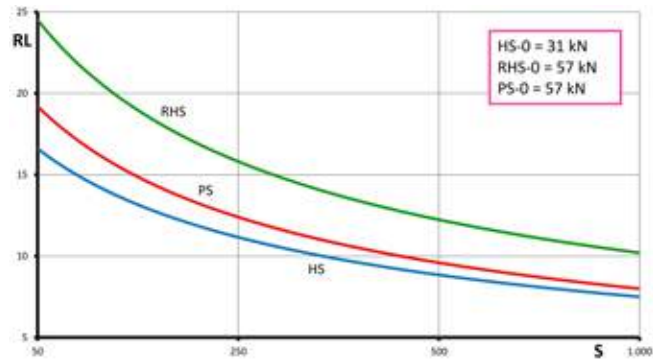
RHS = reinforced hub shaft
PS = Solid protruding shaft
HS-0 = Hub shaft static load [kN]
PS-0 = solid shaft static load [kN]



Motor Models

	IEC	Worm screw bore diameter	Centering diameter	Nominal power (4 poles motor)
	IEC 160 B5 / B14	42 mm	250 mm / 180 mm	15 kW
	IEC 180 B5	48 mm	250 mm	22 kW
	IEC 225 B5	55 mm	350 mm	45 kW
	IEC 250 B5	60 mm	450 mm	55 kW
	IEC 200 B5	55 mm	400 mm	30 kW

Construction Forms (1/1)

Construction Forms (1/1,5 1/2 1/3 1/4)



Size 250 - Reinforced hub shaft



RK Model

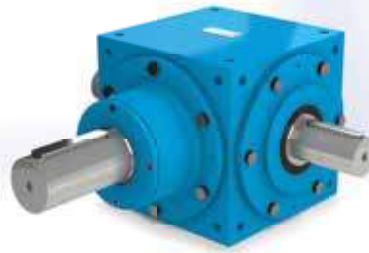

RW Model



RY Model

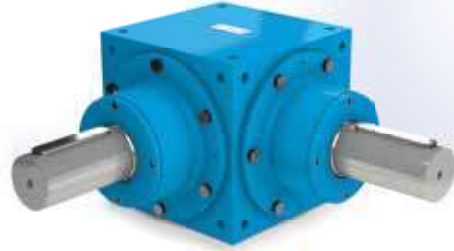

RZ Model

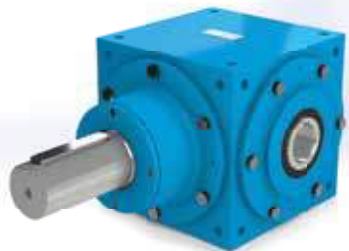

RR Model

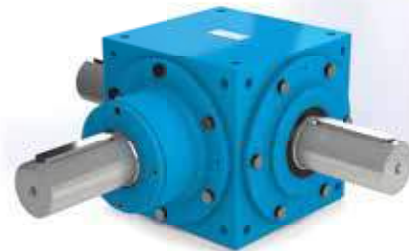

RP Model

Materials

	Material	Norms	Specs	Indications
Hollow shaft / Solid shaft	C45	EN 10083-2:2006	Carbon steel	
Hub shaft	C45	EN 10083-2:2006	Carbon steel	
Carter	GJL 250	EN 1561:2011	Grey cast iron	Completely machined on 6 faces
Bevel gears	17NiCrMo 6-4	EN 10084:2008	Casehardening alloy steel	Ground bores and planes. Gleason gears run by pair.
Lubricant	Unimec Atir SH150		Synthetic oil	3,1 lt

General features

Efficiency	90 %	Hollow shaft maximum moment	3900 Nm (RK - RY - RR)
Gear backlash	15' - 20'	Solid shaft maximum moment	3900 Nm (RW) - 8000 Nm (RP)
Forced lubrication speed	800 rpm	Max input speed	1000 rpm
Grease lubrication speed	100 rpm	Main Gearbox Weight	105 kg
Operating temperature	-10 °C / 80 °C	Standard Working Conditions	25 °C - regular working - 10.000 hours of expected life

Specific features

	1/1	1/1,5	Nominal Ratios 1/2	1/3	1/4
Phase between keys	+/- 6°	+/- 5,5°	+/- 6°	+/- 5°	+/- 4,5°
Inertia moment	0,0915 kg-m ²	0,0328 kg-m ²	0,0177 kg-m ²	8670 kg-mm ²	5830 kg-mm ²

Power curves

La zona magenta indica un potenziale rischio di accumulo di calore. I cicli di lavoro devono essere analizzati con cura.

S = Rotational speed of the fast/slow shaft [rpm]
 CL = Slow shaft torque [Nm]
 P = requested input power [kW]

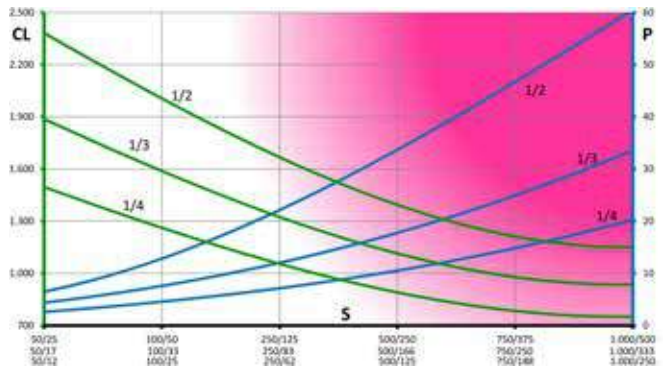
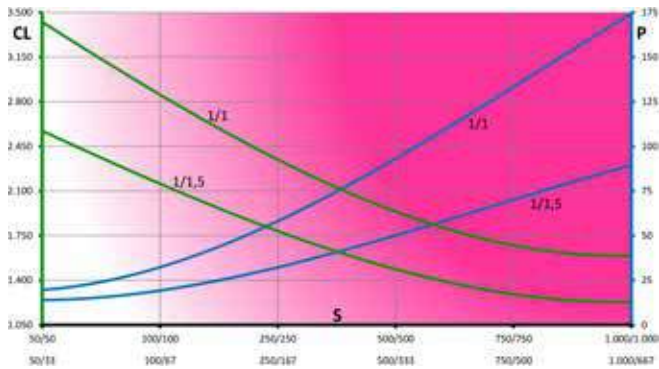

Max admissible loads

S = Fast shaft rotational speed [rpm]
 RL = Admissible radial load [kN]
 AL = Admissible axial load [kN]
 HS = Hub shaft

RHS = reinforced hub shaft
 PS = Solid protruding shaft
 HS-0 = Hub shaft static load [kN]
 PS-0 = solid shaft static load [kN]

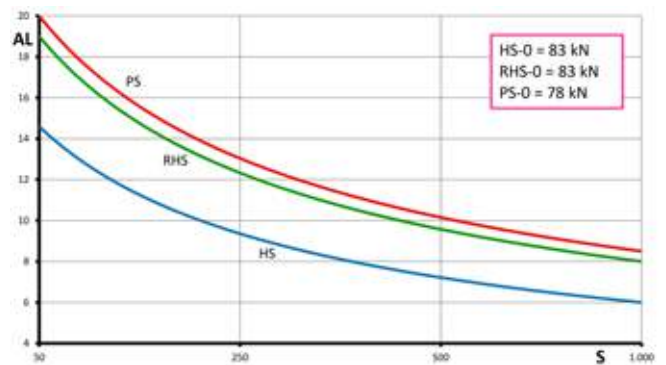
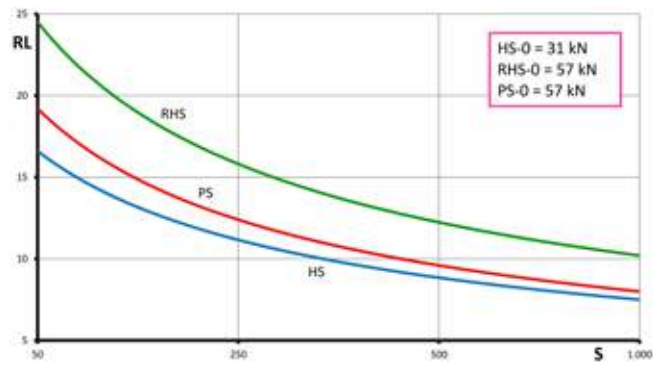

Construction Forms (1/1)

Construction Forms (1/1,5 1/2 1/3 1/4)



Form C1



Form C3



Form S1



Form C2



Form C4



Form S2



Form S3



Form S4



Form S31



Form S9



Form S10



Form S32



Size 350 standard



RA Model



RM Model



RB Model

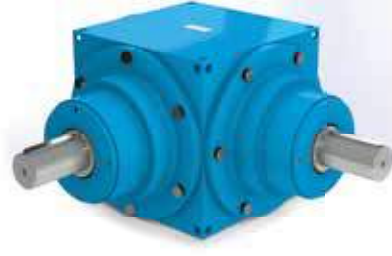

RX Model



RC Model



RS Model

Materials

	Material	Norms	Specs	Indications
Hollow shaft / Solid shaft	C45	EN 10083-2:2006	Carbon steel	
Hub shaft	C45	EN 10083-2:2006	Carbon steel	
Carter	GJL 250	EN 1561:2011	Grey cast iron	Completely machined on 6 faces
Bevel gears	17NiCrMo 6-4	EN 10084:2008	Casehardening alloy steel	Ground bores and planes. Gleason gears run by pair.
Lubricant	Unimec Atir SH150		Synthetic oil	11 lt

General features

Efficiency	90 %	Hollow shaft maximum moment	12000 Nm (RA - RB - RC)
Gear backlash	15' - 20'	Solid shaft maximum moment	12000 Nm (RM) - 14500 Nm (RS)
Forced lubrication speed	600 rpm	Max input speed	750 rpm
Grease lubrication speed	100 rpm	Main Gearbox Weight	175 kg
Operating temperature	-10 °C / 80 °C	Standard Working Conditions	25 °C - regular working - 10.000 hours of expected life

Specific features

	1/1	1/1,5	Nominal Ratios 1/2	1/3	1/4
Phase between keys	+/- 4°	+/- 4°	+/- 4°	+/- 3,5°	+/- 3,5°
Inertia moment	0,7553 kg-m ²	0,2617 kg-m ²	0,1392 kg-m ²	61600 kg-mm ²	35200 kg-mm ²

Power curves

La zona magenta indica un potenziale rischio di accumulo di calore. I cicli di lavoro devono essere analizzati con cura.

S = Rotational speed of the fast/slow shaft [rpm]
 CL = Slow shaft torque [Nm]
 P = requested input power [kW]

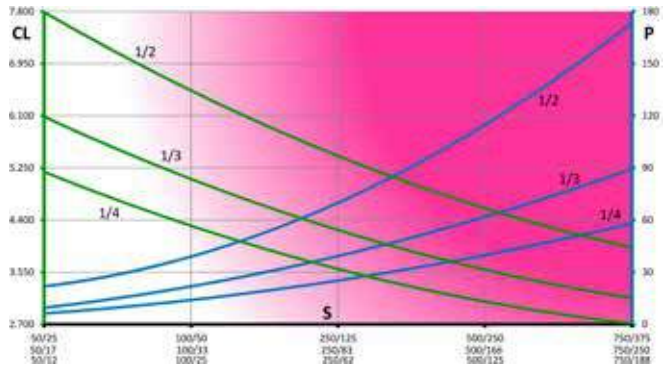
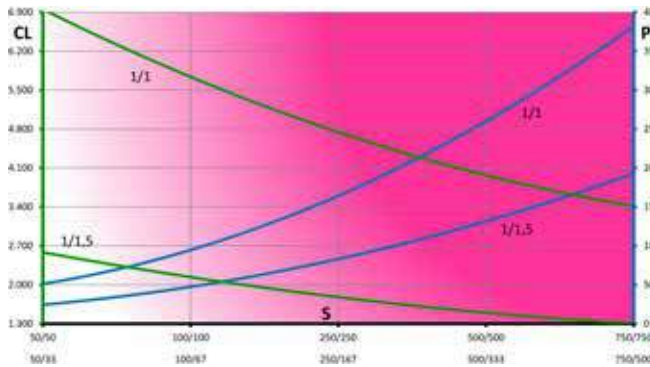

Max admissible loads

S = Fast shaft rotational speed [rpm]
 RL = Admissible radial load [kN]
 AL = Admissible axial load [kN]
 HS = Hub shaft

RHS = reinforced hub shaft
 PS = Solid protruding shaft
 HS-0 = Hub shaft static load [kN]
 PS-0 = solid shaft static load [kN]

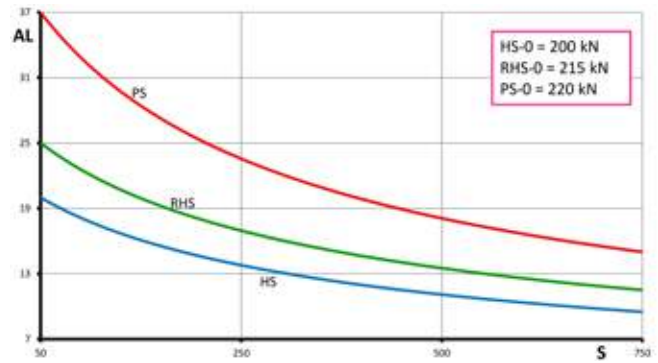
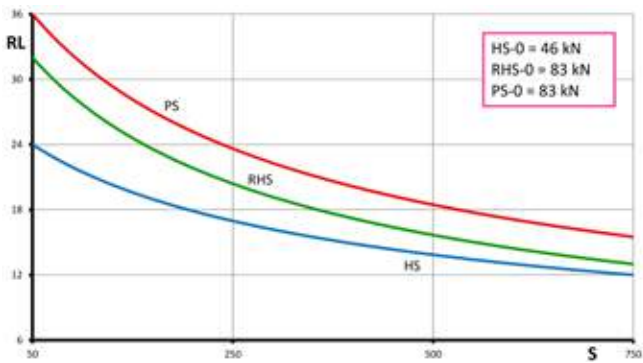

Construction Forms (1/1)

Construction Forms (1/1,5 1/2 1/3 1/4)



Form C1



Form C3



Form S1



Form C2



Form C4



Form S2



Form S3



Form S4



Form S31



Form S9



Form S10



Form S32



Size 350 - Reinforced hub shaft



RK Model



RW Model



RY Model

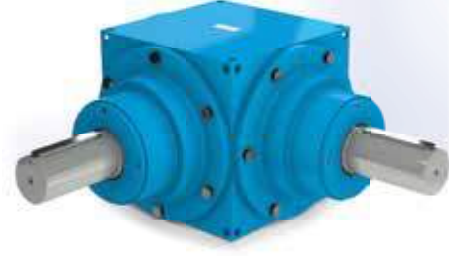

RZ Model



RR Model

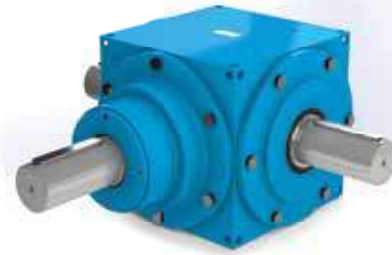

RP Model

Materials

	Material	Norms	Specs	Indications
Hollow shaft / Solid shaft	C45	EN 10083-2:2006	Carbon steel	
Hub shaft	C45	EN 10083-2:2006	Carbon steel	
Carter	GJL 250	EN 1561:2011	Grey cast iron	Completely machined on 6 faces
Bevel gears	17NiCrMo 6-4	EN 10084:2008	Casehardening alloy steel	Ground bores and planes. Gleason gears run by pair.
Lubricant	Unimec Atir SH150		Synthetic oil	11 lt

General features

Efficiency	90 %	Hollow shaft maximum moment	12000 Nm (RK - RY - RR)
Gear backlash	15' - 20'	Solid shaft maximum moment	12000 Nm (RW) - 14500 Nm (RP)
Forced lubrication speed	600 rpm	Max input speed	750 rpm
Grease lubrication speed	100 rpm	Main Gearbox Weight	175 kg
Operating temperature	-10 °C / 80 °C	Standard Working Conditions	25 °C - regular working - 10.000 hours of expected life

Specific features

	1/1	1/1,5	Nominal Ratios 1/2	1/3	1/4
Phase between keys	+/- 4°	+/- 4°	+/- 4°	+/- 3,5°	+/- 3,5°
Inertia moment	0,7553 kg-m ²	0,2617 kg-m ²	0,1392 kg-m ²	61600 kg-mm ²	35200 kg-mm ²

Power curves

La zona magenta indica un potenziale rischio di accumulo di calore. I cicli di lavoro devono essere analizzati con cura.

S = Rotational speed of the fast/slow shaft [rpm]
 CL = Slow shaft torque [Nm]
 P = requested input power [kW]

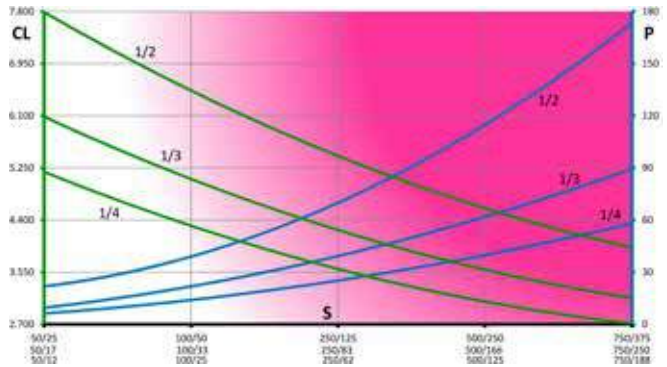
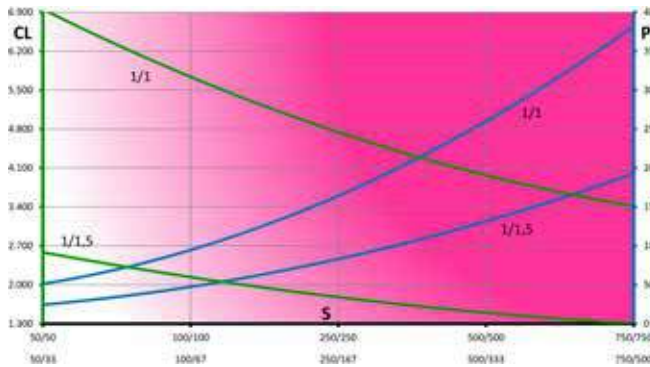

Max admissible loads

S = Fast shaft rotational speed [rpm]
 RL = Admissible radial load [kN]
 AL = Admissible axial load [kN]
 HS = Hub shaft

RHS = reinforced hub shaft
 PS = Solid protruding shaft
 HS-0 = Hub shaft static load [kN]
 PS-0 = solid shaft static load [kN]

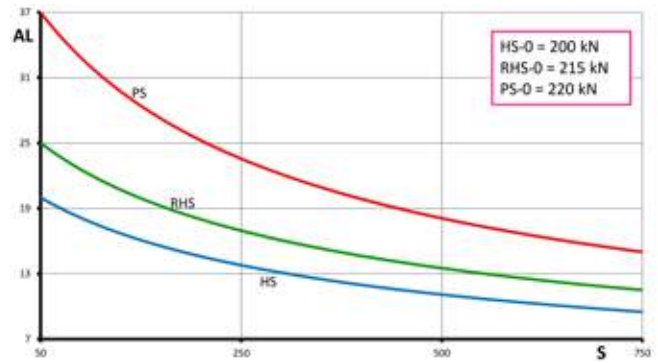
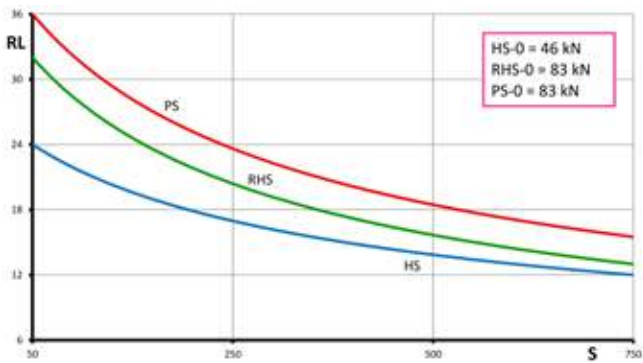

Construction Forms (1/1)

Construction Forms (1/1,5 1/2 1/3 1/4)



Form C1



Form C3



Form S1



Form C2



Form C4



Form S2



Form S3



Form S4



Form S31



Form S9



Form S10



Form S32



Size 500



RA Model



RM Model



RB Model

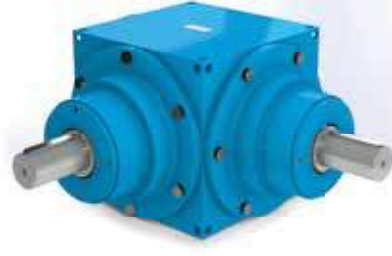

RX Model



RC Model



RS Model

Materials

	Material	Normative	Specs	Indications
Hollow shaft / Solid shaft	C45	EN 10083-2:2006	Carbon steel	
Hub shaft	C45	EN 10083-2:2006	Carbon steel	
Carter	S235 J0	EN 10025-2:2005	Welded carbon steel	Completely machined on 6 faces
Bevel gears	17NiCrMo 6-4	EN 10084:2008	Casehardening alloy steel	Ground bores and planes. Gleason gears run by pair.
Lubricant	Unimec Atir SH150		Synthetic oil	28 lt

General features

Efficiency	90 %	Hollow shaft maximum moment	54000 Nm (RA - RB - RC)
Gear backlash	15' - 20'	Solid shaft maximum moment	54000 Nm (RM - RS)
Forced lubrication speed	300 rpm	Max input speed	500 rpm
Grease lubrication speed	100 rpm	Main Gearbox Weight	1050 kg
Operating temperature	-10 °C / 80 °C	Standard Working Conditions	25 °C - regular working - 10.000 hours of expected life

Specific features

	1/1	1/1,5	Nominal Ratios 1/2	1/3	1/4
Phase between keys	+/- 4°	+/- 4°	+/- 4°	+/- 3,5°	+/- 3,5°
Inertia moment	1,7372 kg-m ²	0,602 kg-m ²	0,32 kg-m ²	0,142 kg-m ²	81000 kg-mm ²



Power curves

La zona magenta indica un potenziale rischio di accumulo di calore. I cicli di lavoro devono essere analizzati con cura.

S = Rotational speed of the fast/slow shaft [rpm]
 CL = Slow shaft torque [Nm]
 P = requested input power [kW]

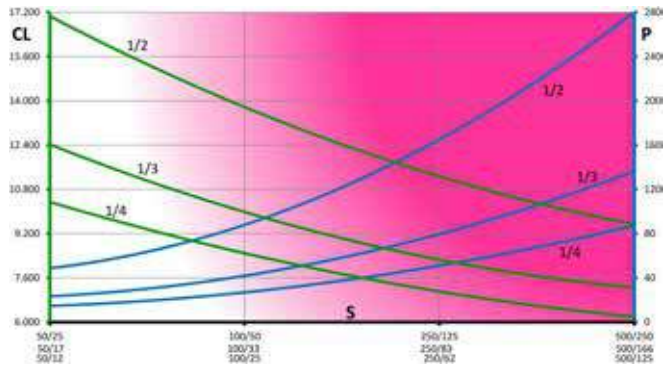
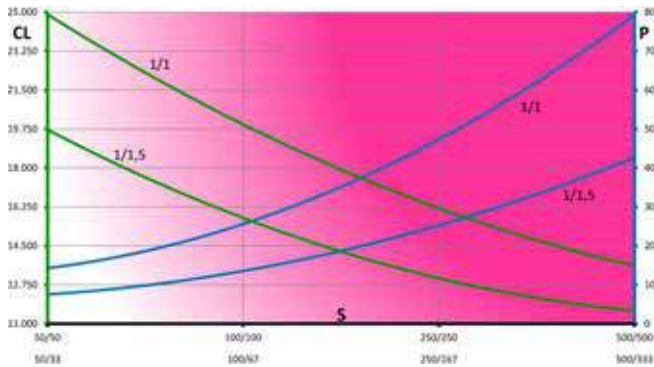

Max admissible loads

S = Fast shaft rotational speed [rpm]
 RL = Admissible radial load [kN]
 AL = Admissible axial load [kN]
 HS = Hub shaft

RHS = reinforced hub shaft
 PS = Solid protruding shaft
 HS-0 = Hub shaft static load [kN]
 PS-0 = solid shaft static load [kN]

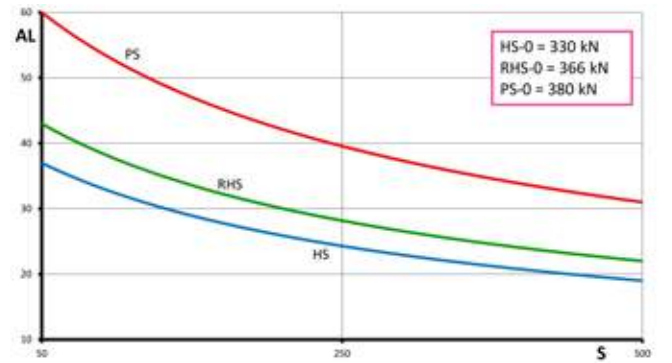
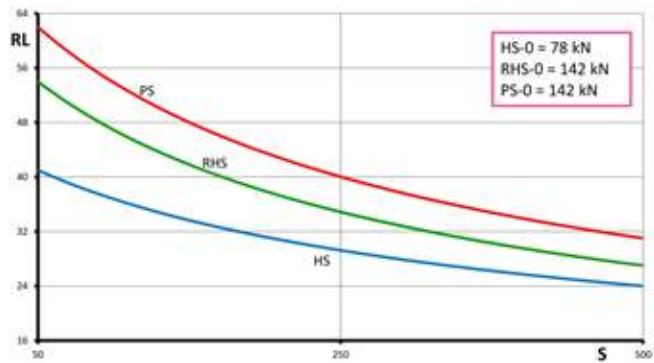

Construction Forms (1/1)

Construction Forms (1/1,5 1/2 1/3 1/4)



Form C1



Form C3



Form S1



Form C2



Form C4



Form S2



Form S3



Form S4



Form S31



Form S9



Form S10



Form S32





Stainless steel bevel gearboxes



The use of stainless steel has had an exponential growth in the last years. New market demands, hygienic requirements in food industry and the applications in oxidizing environments require an higher and higher employment of stainless materials.

From the beginning UNIMEC has been able to supply its products in stainless steel for its customers. Anyway, realizing those components meant long manufacturing times. For the most requested products and sizes UNIMEC is now able to propose a complete series: the X series.

This choice gives multiple advantages: on the one hand a shortening of the delivery times as the components are all available on stock, on the other hand the manufacturing allows to obtain quite interesting costs, because it starts from the row casted pieces.

The main feature of an AISI 316 steel is its high resistance to corrosion, above all in the sea and food environments, where AISI 304 seems to have some problems. The table below lists a series of substances which are normally critical for common type steels and puts in evidence the AISI 316 resistance as compared to the AISI 304 one.

Gear boxes belonging to the X series are sizes 54, 86, 110, 134 in all construction models.

The components made of stainless steel are casings, hubs, covers, motor flanges, and all the hollow as well as the protruding shafts.

Size 54 standard



XRA Model



XRM Model



XRB Model



XRX Model



XRC Model



XRS Model

Materials

	Material	Norms	Specs	Indications
Hollow shaft / Solid shaft	X5 CrNiMo 17-12-2 (AISI 316)	EN 10088-1:2014	Stainless steel	
Hub shaft	X5 CrNiMo 17-12-2 (AISI 316)	EN 10088-1:2014	Stainless steel	
Carter	X5 CrNiMo 17-12-2 (AISI 316)	EN 10088-1:2014	Stainless steel	Completely machined on 6 faces
Bevel gears	17NiCrMo 6-4	EN 10084:2008	Casehardening alloy steel	Ground bores and planes. Gleason gears run by pair.
Lubricant	Unimec Atir SH150		Synthetic oil	0,02 lt

General features

Efficiency	90 %	Hollow shaft maximum moment	40 Nm (XRA - XRB - XRC)
Gear backlash	15' - 20'	Solid shaft maximum moment	40 Nm (XRM) - 130 Nm (XRS)
Forced lubrication speed	4000 rpm	Max input speed	4500 rpm
Grease lubrication speed	100 rpm	Main Gearbox Weight	2 kg
Operating temperature	-10 °C / 80 °C	Standard Working Conditions	25 °C - regular working - 10.000 hours of expected life

Specific features

	1/1	1/1,5	Nominal Ratios 1/2	1/3	1/4
Phase between keys	+/- 8°	+/- 5°	+/- 5°	+/- 5°	+/- 5°
Inertia moment	134 kg-mm ²	50 kg-mm ²	27 kg-mm ²	16 kg-mm ²	11 kg-mm ²



Power curves

The magenta zone indicates a potential heating risk. Working cycles must be carefully analyzed.

S = Rotational speed of the fast/slow shaft [rpm]
 CL = Slow shaft torque [Nm]
 P = requested input power [kW]

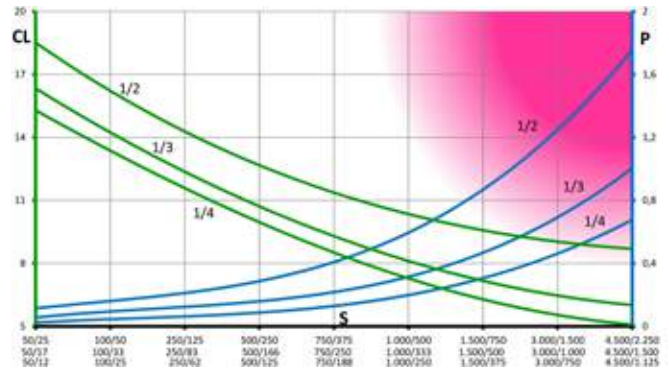
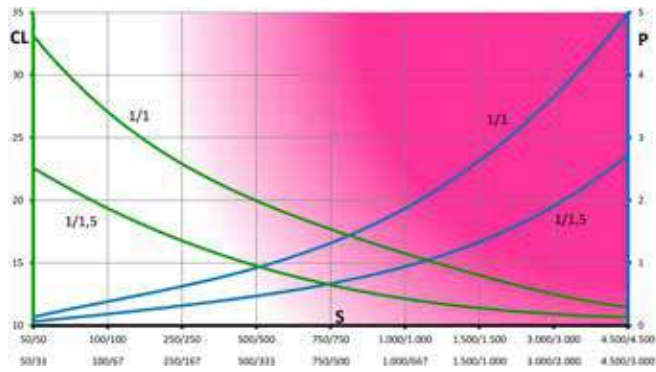

Max admissible loads

S = Fast shaft rotational speed [rpm]
 RL = Admissible radial load [kN]
 AL = Admissible axial load [kN]
 HS = Hub shaft

RHS = reinforced hub shaft
 PS = Solid protruding shaft
 HS-0 = Hub shaft static load [kN]
 PS-0 = solid shaft static load [kN]

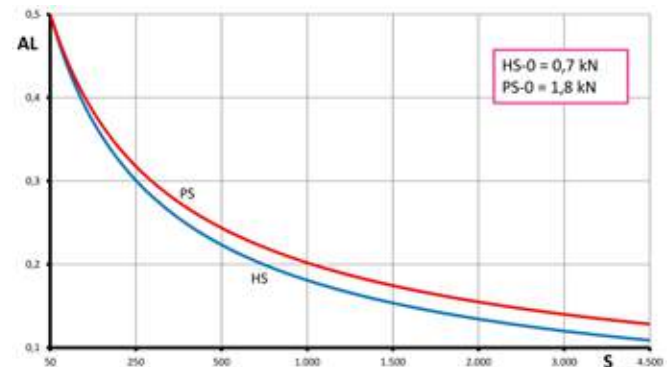
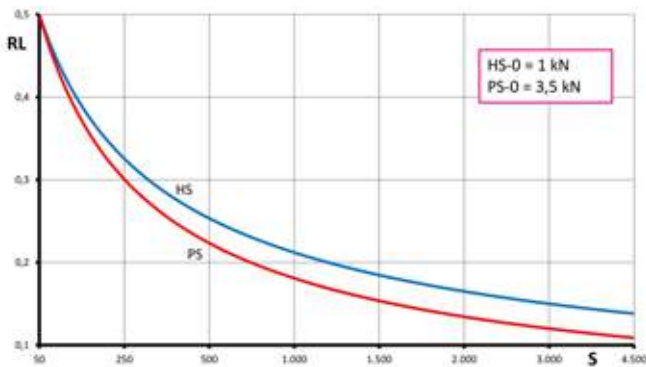

Construction Forms (1/1)

Construction Forms (1/1,5 1/2 1/3 1/4)



Form C1



Form C3



Form S1



Form C2



Form C4



Form S2



Form S3



Form S4



Form S31



Form S9



Form S10



Form S32



Size 86 standard



XRA Model



XRM Model



XRB Model



XRX Model



XRC Model



XRS Model

› Materials

	Material	Norms	Specs	Indications
Hollow shaft / Solid shaft	X5 CrNiMo 17-12-2 (AISI 316)	EN 10088-1:2014	Stainless steel	
Hub shaft	X5 CrNiMo 17-12-2 (AISI 316)	EN 10088-1:2014	Stainless steel	
Carter	X5 CrNiMo 17-12-2 (AISI 316)	EN 10088-1:2014	Stainless steel	Completely machined on 6 faces
Bevel gears	17NiCrMo 6-4	EN 10084:2008	Casehardening alloy steel	Ground bores and planes. Gleason gears run by pair.
Lubricant	Unimec Atir SH150		Synthetic oil	0,1 lt

› General features

Efficiency	90 %	Hollow shaft maximum moment	90 Nm (XRA - XRB - XRC)
Gear backlash	15' - 20'	Solid shaft maximum moment	90 Nm (XRM) - 320 Nm (XRS)
Forced lubrication speed	3000 rpm	Max input speed	4500 rpm
Grease lubrication speed	100 rpm	Main Gearbox Weight	6,5 kg
Operating temperature	-10 °C / 80 °C	Standard Working Conditions	25 °C - regular working - 10.000 hours of expected life

› Specific features

	1/1	1/1,5	Nominal Ratios 1/2	1/3	1/4
Phase between keys	+/- 6,5°	+/- 6°	+/- 6°	+/- 6°	+/- 4,5°
Inertia moment	366 kg-mm ²	136 kg-mm ²	74 kg-mm ²	37 kg-mm ²	26 kg-mm ²

Power curves

The magenta zone indicates a potential heating risk. Working cycles must be carefully analyzed.

S = Rotational speed of the fast/slow shaft [rpm]
 CL = Slow shaft torque [Nm]
 P = requested input power [kW]

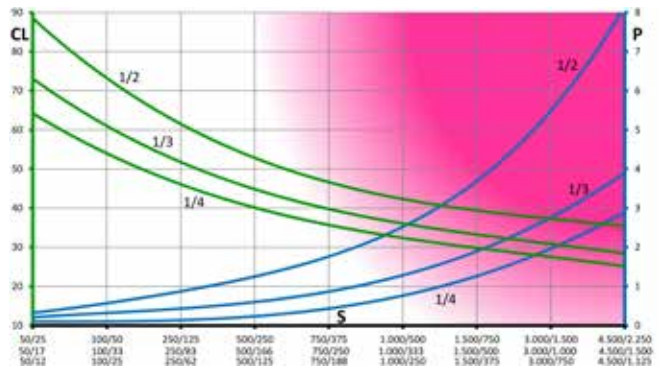
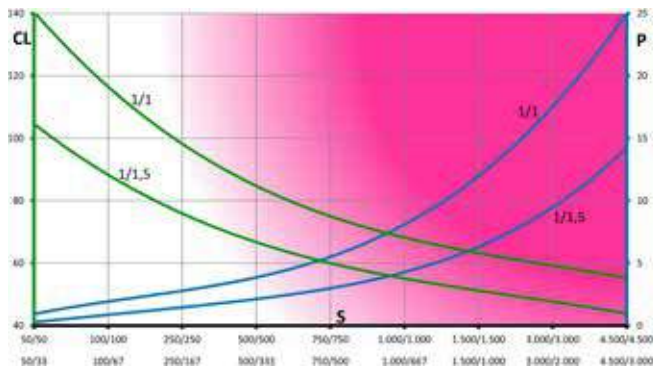

Max admissible loads

S = Fast shaft rotational speed [rpm]
 RL = Admissible radial load [kN]
 AL = Admissible axial load [kN]
 HS = Hub shaft

RHS = reinforced hub shaft
 PS = Solid protruding shaft
 HS-0 = Hub shaft static load [kN]
 PS-0 = solid shaft static load [kN]

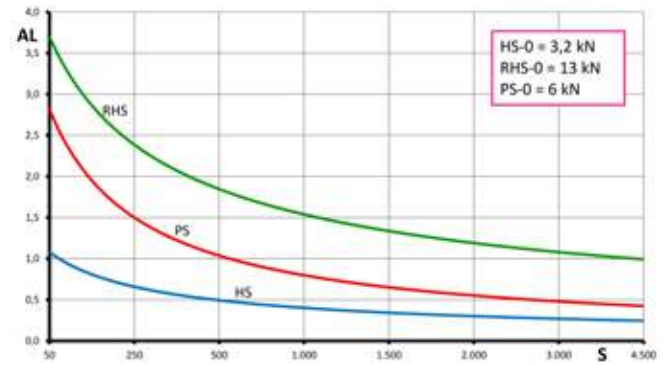
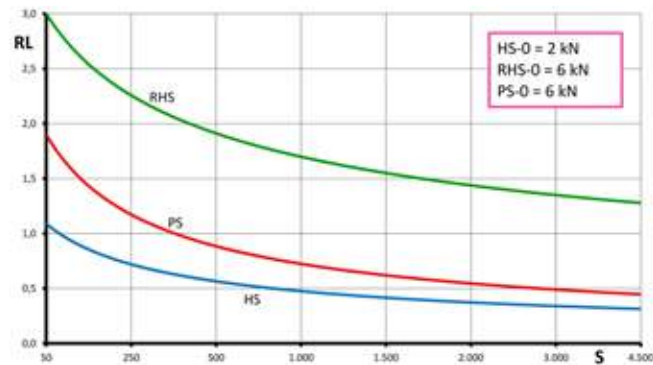

Motor Models

	IEC	Worm screw bore diameter	Centering diameter	Nominal power (4 poles motor)
	IEC 63 B5	11 mm	95 mm	0,25 kW
	IEC 71 B5 / B14	14 mm	110 mm / 70 mm	0,55 kW
	IEC 80 B5 / B14	19 mm	130 mm / 80 mm	1,1 kW
	IEC 90 B5 / B14	24 mm	130 mm / 95 mm	1,9 kW

Construction Forms (1/1)

Construction Forms (1/1,5 1/2 1/3 1/4)



Size 86 - Reinforced hub shaft



XRK Model



XRW Model



XRY Model



XRZ Model



XRR Model



XRP Model

Materials

	Material	Norms	Specs	Indications
Hollow shaft / Solid shaft	X5 CrNiMo 17-12-2 (AISI 316)	EN 10088-1:2014	Stainless steel	
Hub shaft	X5 CrNiMo 17-12-2 (AISI 316)	EN 10088-1:2014	Stainless steel	
Carter	X5 CrNiMo 17-12-2 (AISI 316)	EN 10088-1:2014	Stainless steel	Completely machined on 6 faces
Bevel gears	17NiCrMo 6-4	EN 10084:2008	Casehardening alloy steel	Ground bores and planes. Gleason gears run by pair.
Lubricant	Unimec Atir SH150		Synthetic oil	0,1 lt

General features

Efficiency	90 %	Hollow shaft maximum moment	90 Nm (XRK - XRY - XRR)
Gear backlash	15' - 20'	Solid shaft maximum moment	90 Nm (XRW) - 320 Nm (XRP)
Forced lubrication speed	3000 rpm	Max input speed	4500 rpm
Grease lubrication speed	100 rpm	Main Gearbox Weight	6,5 kg
Operating temperature	-10 °C / 80 °C	Standard Working Conditions	25 °C - regular working - 10.000 hours of expected life

Specific features

	1/1	1/1,5	Nominal Ratios 1/2	1/3	1/4
Phase between keys	+/- 6,5°	+/- 6°	+/- 6°	+/- 6°	+/- 4,5°
Inertia moment	366 kg-mm ²	136 kg-mm ²	74 kg-mm ²	37 kg-mm ²	26 kg-mm ²

Power curves

The magenta zone indicates a potential heating risk. Working cycles must be carefully analyzed.

S = Rotational speed of the fast/slow shaft [rpm]
 CL = Slow shaft torque [Nm]
 P = requested input power [kW]

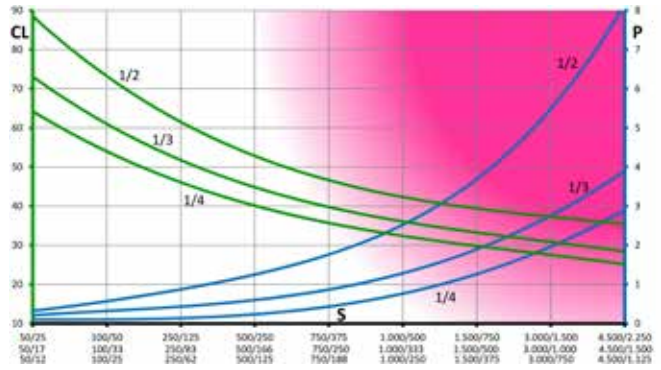
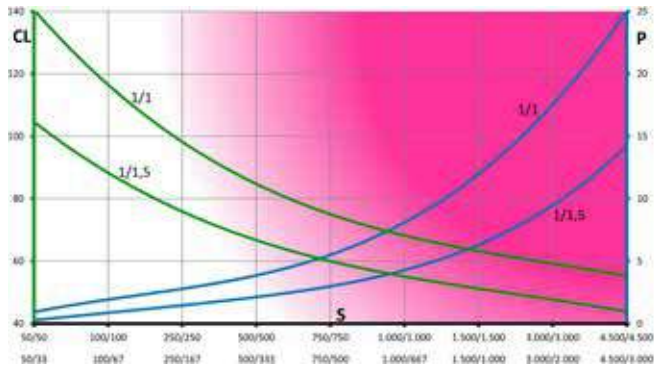

Max admissible loads

S = Fast shaft rotational speed [rpm]
 RL = Admissible radial load [kN]
 AL = Admissible axial load [kN]
 HS = Hub shaft

RHS = reinforced hub shaft
 PS = Solid protruding shaft
 HS-0 = Hub shaft static load [kN]
 PS-0 = solid shaft static load [kN]

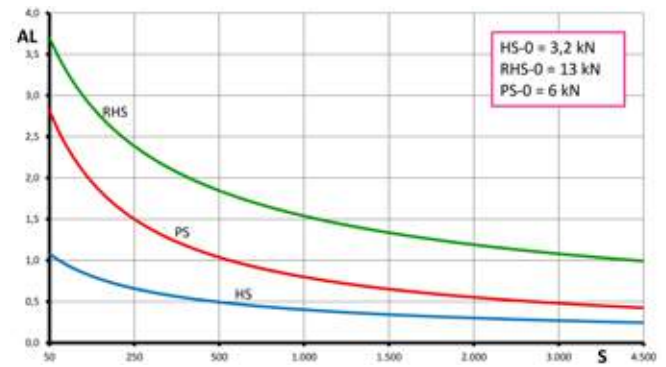
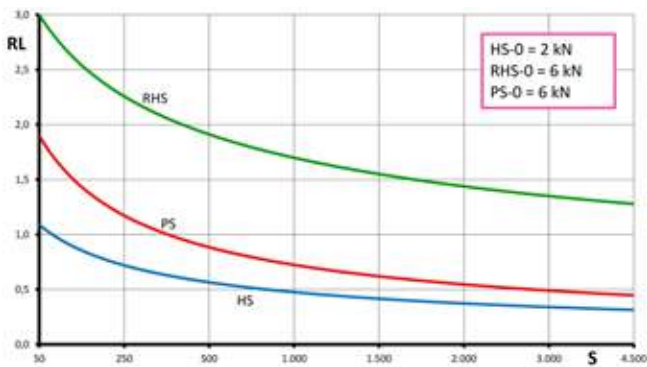

Construction Forms (1/1)

Construction Forms (1/1,5 1/2 1/3 1/4)



Form C1



Form C3



Form S1



Form C2



Form C4



Form S2



Form S3



Form S4



Form S31



Form S9



Form S10



Form S32



Size 110 standard



XRA Model



XRM Model



XRB Model



XRX Model



XRC Model



XRS Model

Materials

	Material	Norms	Specs	Indications
Hollow shaft / Solid shaft	X5 CrNiMo 17-12-2 (AISI 316)	EN 10088-1:2014	Stainless steel	
Hub shaft	X5 CrNiMo 17-12-2 (AISI 316)	EN 10088-1:2014	Stainless steel	
Carter	X5 CrNiMo 17-12-2 (AISI 316)	EN 10088-1:2014	Stainless steel	Completely machined on 6 faces
Bevel gears	17NiCrMo 6-4	EN 10084:2008	Casehardening alloy steel	Ground bores and planes. Gleason gears run by pair.
Lubricant	Unimec Atir SH150		Synthetic oil	0,2 lt

General features

Efficiency	90 %	Hollow shaft maximum moment	180 Nm (XRA - XRB - XRC)
Gear backlash	15' - 20'	Solid shaft maximum moment	180 Nm (XRM) - 320 Nm (XRS)
Forced lubrication speed	2500 rpm	Max input speed	3000 rpm
Grease lubrication speed	100 rpm	Main Gearbox Weight	10 kg
Operating temperature	-10 °C / 80 °C	Standard Working Conditions	25 °C - regular working - 10.000 hours of expected life

Specific features

	1/1	1/1,5	Nominal Ratios 1/2	1/3	1/4
Phase between keys	+/- 5,5°	+/- 5,5°	+/- 6°	+/- 4,5°	+/- 4,5°
Inertia moment	798 kg-mm ²	300 kg-mm ²	168 kg-mm ²	89 kg-mm ²	63 kg-mm ²

Power curves

The magenta zone indicates a potential heating risk. Working cycles must be carefully analyzed.

S = Rotational speed of the fast/slow shaft [rpm]
 CL = Slow shaft torque [Nm]
 P = requested input power [kW]

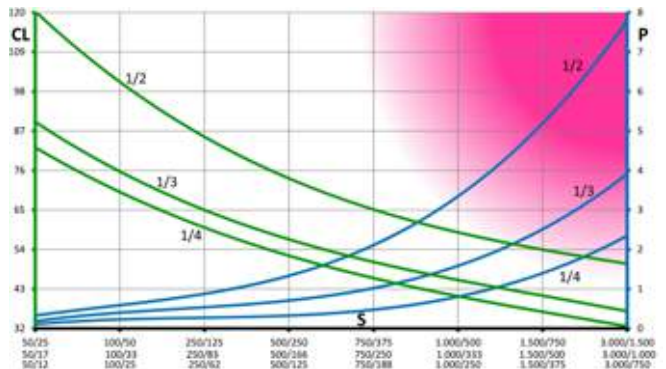
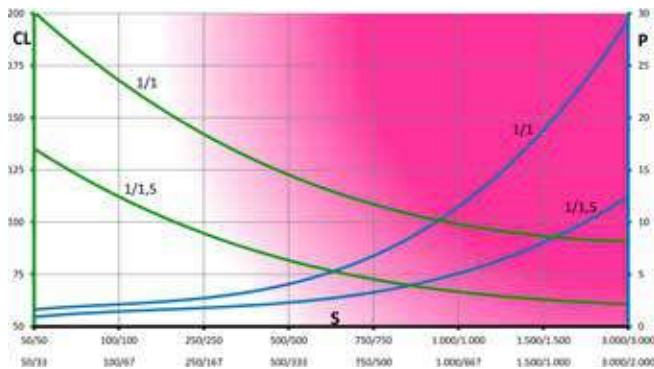



Max admissible loads

S = Fast shaft rotational speed [rpm]
 RL = Admissible radial load [kN]
 AL = Admissible axial load [kN]
 HS = Hub shaft

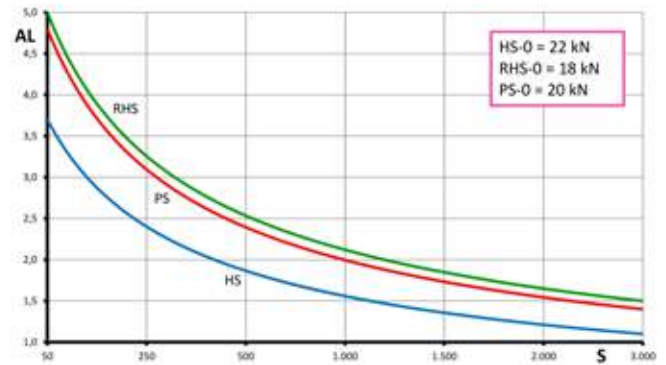
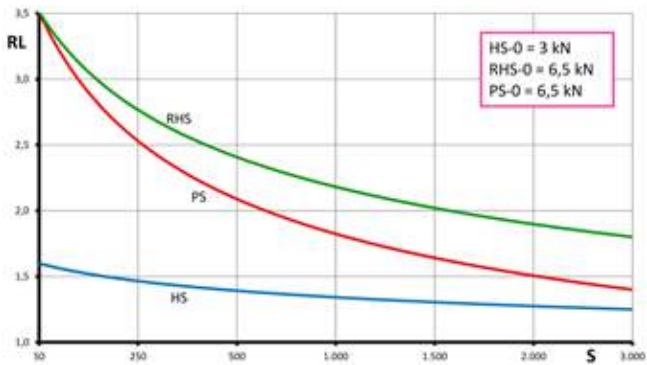
RHS = reinforced hub shaft
 PS = Solid protruding shaft
 HS-0 = Hub shaft static load [kN]
 PS-0 = solid shaft static load [kN]



Motor Models

	IEC	Worm screw bore diameter	Centering diameter	Nominal power (4 poles motor)
	IEC 80 B5 / B14	19 mm	130 mm / 80 mm	1,1 kW
	IEC 90 B5 / B14	24 mm	130 mm / 95 mm	1,9 kW

Construction Forms (1/1)

Construction Forms (1/1,5 1/2 1/3 1/4)



Size 110 - Reinforced hub shaft



XRK Model



XRW Model



XRY Model



XRZ Model



XRR Model



XRP Model

Materials

	Material	Norms	Specs	Indications
Hollow shaft / Solid shaft	X5 CrNiMo 17-12-2 (AISI 316)	EN 10088-1:2014	Stainless steel	
Hub shaft	X5 CrNiMo 17-12-2 (AISI 316)	EN 10088-1:2014	Stainless steel	
Carter	X5 CrNiMo 17-12-2 (AISI 316)	EN 10088-1:2014	Stainless steel	Completely machined on 6 faces
Bevel gears	17NiCrMo 6-4	EN 10084:2008	Casehardening alloy steel	Ground bores and planes. Gleason gears run by pair.
Lubricant	Unimec Atir SH150		Synthetic oil	0,2 lt

General features

Efficiency	90 %	Hollow shaft maximum moment	180 Nm (XRK - XRY - XRR)
Gear backlash	15' - 20'	Solid shaft maximum moment	180 Nm (XRW) - 410 Nm (XRP)
Forced lubrication speed	2500 rpm	Max input speed	3000 rpm
Grease lubrication speed	100 rpm	Main Gearbox Weight	10 kg
Operating temperature	-10 °C / 80 °C	Standard Working Conditions	25 °C - regular working - 10.000 hours of expected life

Specific features

	1/1	1/1,5	Nominal Ratios 1/2	1/3	1/4
Phase between keys	+/- 5,5°	+/- 5,5°	+/- 6°	+/- 4,5°	+/- 4,5°
Inertia moment	798 kg-mm ²	300 kg-mm ²	168 kg-mm ²	89 kg-mm ²	63 kg-mm ²

Power curves

The magenta zone indicates a potential heating risk. Working cycles must be carefully analyzed.

S = Rotational speed of the fast/slow shaft [rpm]
 CL = Slow shaft torque [Nm]
 P = requested input power [kW]

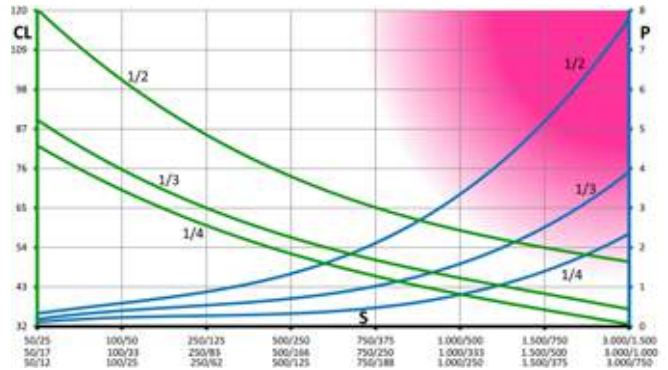
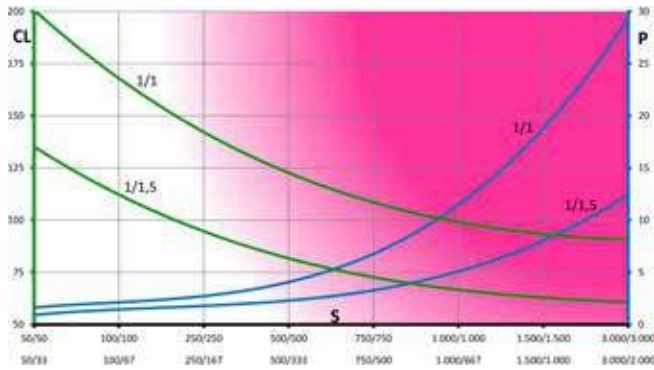

Max admissible loads

S = Fast shaft rotational speed [rpm]
 RL = Admissible radial load [kN]
 AL = Admissible axial load [kN]
 HS = Hub shaft

RHS = reinforced hub shaft
 PS = Solid protruding shaft
 HS-0 = Hub shaft static load [kN]
 PS-0 = solid shaft static load [kN]

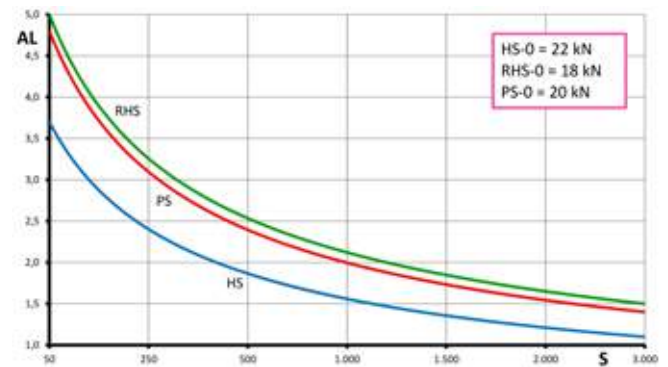
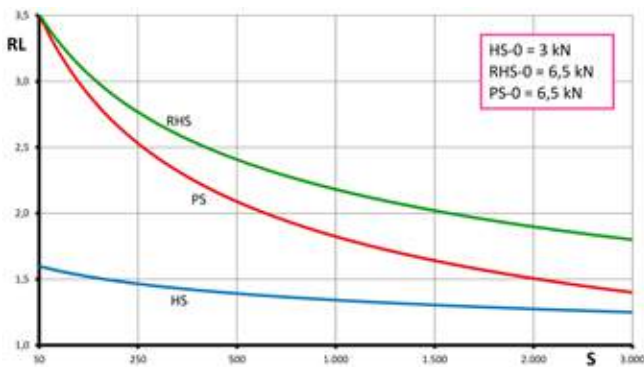

Construction Forms (1/1)

Construction Forms (1/1,5 1/2 1/3 1/4)



Form C1



Form C3



Form S1



Form C2



Form C4



Form S2



Form S3



Form S4



Form S31



Form S9



Form S10



Form S32



Size 134 standard



XRA Model



Model XRM



XRB Model



XRX Model



XRC Model



XRS Model

Materials

	Material	Norms	Specs	Indications
Hollow shaft / Solid shaft	X5 CrNiMo 17-12-2 (AISI 316)	EN 10088-1:2014	Stainless steel	
Hub shaft	X5 CrNiMo 17-12-2 (AISI 316)	EN 10088-1:2014	Stainless steel	
Carter	X5 CrNiMo 17-12-2 (AISI 316)	EN 10088-1:2014	Stainless steel	Completely machined on 6 faces
Bevel gears	17NiCrMo 6-4	EN 10084:2008	Casehardening alloy steel	Ground bores and planes. Gleason gears run by pair.
Lubricant	Unimec Atir SH150		Synthetic oil	0,4 lt

General features

Efficiency	90 %	Hollow shaft maximum moment	320 Nm (XRA - XRB - XRC)
Gear backlash	15' - 20'	Solid shaft maximum moment	320 Nm (XRM) - 770 Nm (XRS)
Forced lubrication speed	2000 rpm	Max input speed	2500 rpm
Grease lubrication speed	100 rpm	Main Gearbox Weight	19 kg
Operating temperature	-10 °C / 80 °C	Standard Working Conditions	25 °C - regular working - 10.000 hours of expected life

Specific features

	1/1	1/1,5	Nominal Ratios 1/2	1/3	1/4
Phase between keys	+/- 6,5°	+/- 5,5°	+/- 6,5°	+/- 5,5°	+/- 4,5°
Inertia moment	2590 kg-mm ²	950 kg-mm ²	535 kg-mm ²	284 kg-mm ²	207 kg-mm ²



Power curves

The magenta zone indicates a potential heating risk. Working cycles must be carefully analyzed.

S = Rotational speed of the fast/slow shaft [rpm]
 CL = Slow shaft torque [Nm]
 P = requested input power [kW]

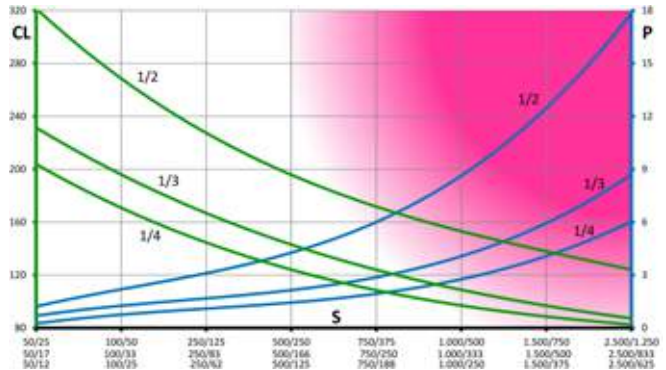
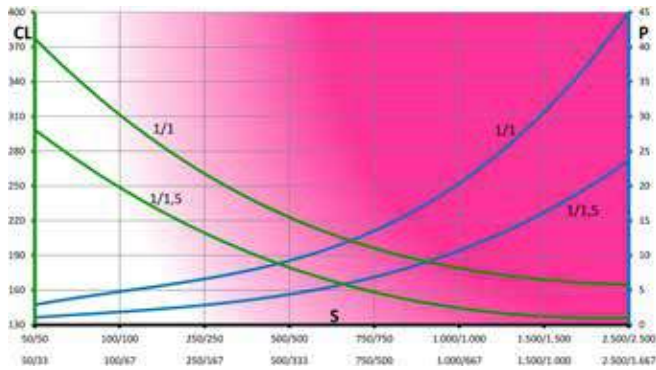

Max admissible loads

S = Fast shaft rotational speed [rpm]
 RL = Admissible radial load [kN]
 AL = Admissible axial load [kN]
 HS = Hub shaft

RHS = reinforced hub shaft
 PS = Solid protruding shaft
 HS-0 = Hub shaft static load [kN]
 PS-0 = solid shaft static load [kN]

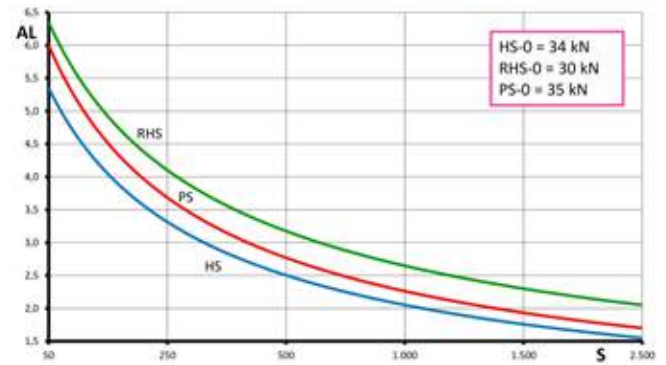
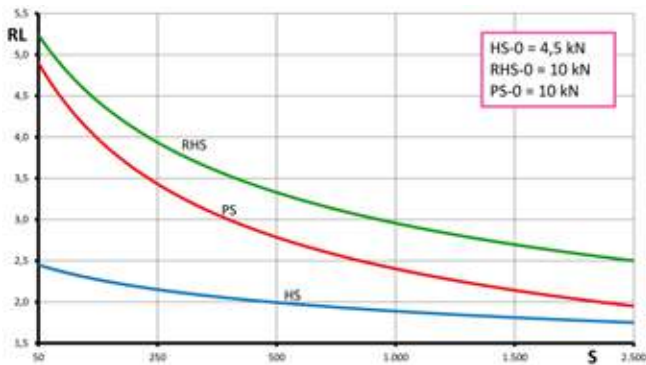

Motor Models

	IEC	Worm screw bore diameter	Centering diameter	Nominal power (4 poles motor)
	IEC 80 B5 / B14	19 mm	130 mm / 80 mm	1,1 kW
	IEC 90 B5 / B14	24 mm	130 mm / 95 mm	1,9 kW
	IEC 100-112 B5 / B14	28 mm	180 mm / 110 mm	5 kW
	IEC 132 B5 / B14	38 mm	230 mm / 130 mm	11 kW

Construction Forms (1/1)

Construction Forms (1/1,5 1/2 1/3 1/4)



Size 134 - Reinforced hub shaft



XRK Model



XRW Model



XRY Model



XRZ Model



XRR Model



XRP Model

Materials

	Material	Norms	Specs	Indications
Hollow shaft / Solid shaft	X5 CrNiMo 17-12-2 (AISI 316)	EN 10088-1:2014	Stainless steel	
Hub shaft	X5 CrNiMo 17-12-2 (AISI 316)	EN 10088-1:2014	Stainless steel	
Carter	X5 CrNiMo 17-12-2 (AISI 316)	EN 10088-1:2014	Stainless steel	Completely machined on 6 faces
Bevel gears	17NiCrMo 6-4	EN 10084:2008	Casehardening alloy steel	Ground bores and planes. Gleason gears run by pair.
Lubricant	Unimec Atir SH150		Synthetic oil	0,4 lt

General features

Efficiency	90 %	Hollow shaft maximum moment	320 Nm (XRK - XRY - XRR)
Gear backlash	15' - 20'	Solid shaft maximum moment	320 Nm (XRW) - 770 Nm (XRP)
Forced lubrication speed	2000 rpm	Max input speed	2500 rpm
Grease lubrication speed	100 rpm	Main Gearbox Weight	19 kg
Operating temperature	-10 °C / 80 °C	Standard Working Conditions	25 °C - regular working - 10.000 hours of expected life

Specific features

	1/1	1/1,5	Nominal Ratios 1/2	1/3	1/4
Phase between keys	+/- 6,5°	+/- 5,5°	+/- 6,5°	+/- 5,5°	+/- 4,5°
Inertia moment	2590 kg-mm ²	950 kg-mm ²	535 kg-mm ²	284 kg-mm ²	207 kg-mm ²

Power curves

The magenta zone indicates a potential heating risk. Working cycles must be carefully analyzed.

S = Rotational speed of the fast/slow shaft [rpm]
 CL = Slow shaft torque [Nm]
 P = requested input power [kW]

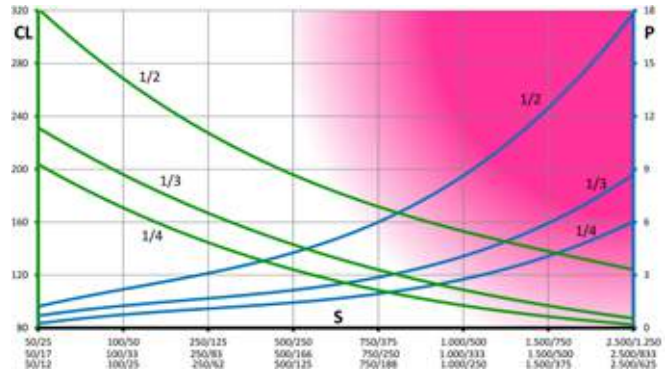
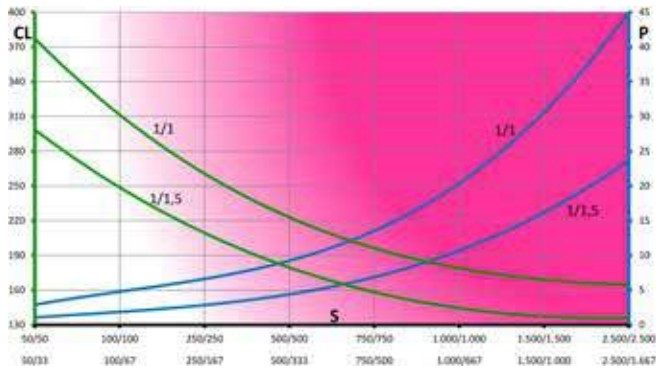

Max admissible loads

S = Fast shaft rotational speed [rpm]
 RL = Admissible radial load [kN]
 AL = Admissible axial load [kN]
 HS = Hub shaft

RHS = reinforced hub shaft
 PS = Solid protruding shaft
 HS-0 = Hub shaft static load [kN]
 PS-0 = solid shaft static load [kN]

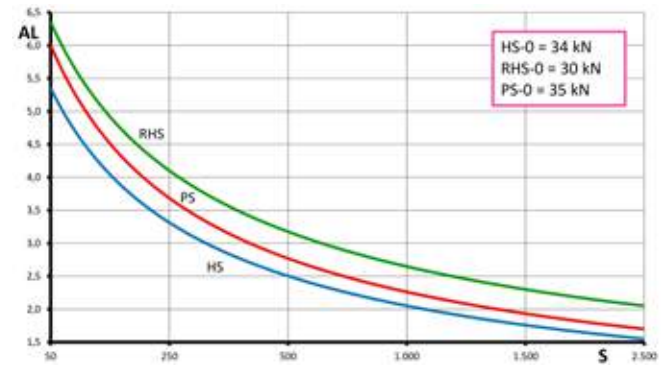
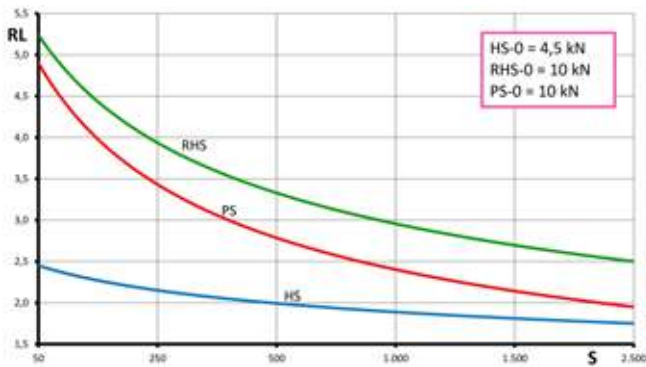

Construction Forms (1/1)

Construction Forms (1/1,5 1/2 1/3 1/4)



Form C1



Form C3



Form S1



Form C2



Form C4



Form S2



Form S3



Form S4



Form S31



Form S9



Form S10



Form S32



CTR Temperature Control

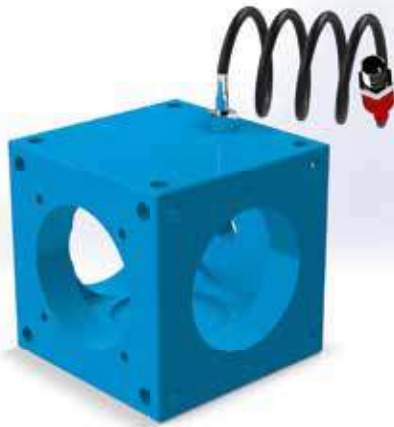

> Specifications



The CTR Temperature Control is a thermal probe embedded in the body of the gearbox. Being able to work continuously, bevel gear reducers can experience considerable rise of temperature with potential premature wear and/or detrimental effects on performance. The ideal operating temperature should be between -40 °C (-40 °F) and 90 °C (194 °F); it is recommended however to

shut the transmission down before the unit reaches the max limit of 90 °C (194 °F) and wait until it cools down to room temperature before resuming.

For application in higher temperature environments and/or continuous operation it is recommended the use of Viton Seals and special high-temp lubricants.

GM1 Additional Hub



> Specifications



In standard configurations, each bevel gear reducer features an input hub and either a hollow shaft (RA, RB, RC, RK, RY and RR types), a protruding shaft (RS, RM, RP and RW types) or a hub shaft (RX and RZ types). Besides the standard forms, additional more complex configurations are available with the integration of a supplemental

hub mounted on one of the free sides of the gearbox. All of the multiple additional options are illustrated in the chart. Please note that the addition of a supplemental hub, determines approximately a 10% reduction of Efficiency and approximately a 15% reduction of the max thermal power.

Ratio	RA / RK	RB / RY	RC / RR	RX / RZ	RS / RP	RM / RW
1/1				S8	S5 - S6 - S7	
1/1,5	C4 - C5	C4 - C5	C4 - C5	S14 - S27 - S33	S11 - S12 - S13 - S15 - S18 - S19	S2 - S9 - S10
1/2	C4 - C5	C4 - C5	C4 - C5	S14 - S27 - S33	S11 - S12 - S13 - S15 - S18 - S19	
1/3	C4 - C5	C4 - C5	C4 - C5	S14 - S27 - S33	S11 - S12 - S13 - S15 - S18 - S19	
1/4	C4 - C5	C4 - C5	C4 - C5	S14 - S27 - S33	S11 - S12 - S13 - S15 - S18 - S19	

GM2 Additional Hubs



> Specifications



In standard configurations, each bevel gear reducer features an input hub and either a hollow shaft (RA, RB, RC, RK, RY and RR types), a protruding shaft (RS and RP types) or a hub shaft (RX and RZ types). Besides the standard forms, additional more complex configurations are available with the integration of two supplemental hubs

mounted on two of the free sides of the gearbox. All of the multiple additional options are illustrated in the chart. Please note that the addition of two supplemental hubs, determines approximately a 20% reduction of Efficiency and approximately a 30% reduction of the max thermal power.

Ratio	RA / RK	RB / RY	RC / RR	RX / RZ	RS / RP
1/1				S26	
1/1,5	C6 - C8	C6 - C8	C6 - C8	S28 - S34	S16 - S20 - S21
1/2	C6 - C8	C6 - C8	C6 - C8	S28 - S34	S16 - S20 - S21
1/3	C6 - C8	C6 - C8	C6 - C8	S28 - S34	S16 - S20 - S21
1/4	C6 - C8	C6 - C8	C6 - C8	S28 - S34	S16 - S20 - S21

GM3 Additional Hubs



> Specifications



In standard configurations, each bevel gear reducer features an input hub and either a hollow shaft (RA, RB, RC, RK, RY and RR types), a protruding shaft (RS and RP types) or a hub shaft (RX and RZ types). Besides the standard forms, additional more complex configurations are available with the integration of

three supplemental hubs mounted on three of the free sides of the gearbox. All of the multiple additional options are illustrated in the chart. Please note that the addition of three supplemental hubs, determines approximately a 30% reduction of Efficiency and approximately a 45% reduction of the max thermal power.

Ratio	RA / RK	RB / RY	RC / RR	RX / RZ	RS / RP
1/1,5	C7	C7	C7	S29	S17 - S22 - S23
1/2	C7	C7	C7	S29	S17 - S22 - S23
1/3	C7	C7	C7	S29	S17 - S22 - S23
1/4	C7	C7	C7	S29	S17 - S22 - S23

GM4 Additional Hubs

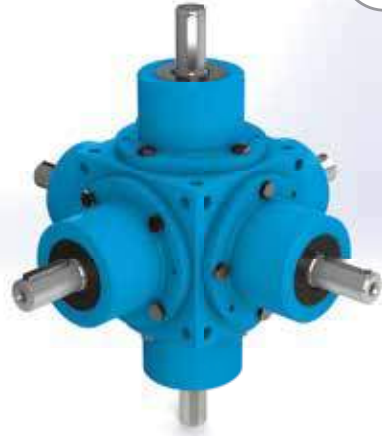

> Specifications



In standard configurations, a RX or RZ bevel gear features an input and output hub shaft. Besides the standard forms, additional more complex configurations are available with the integration of four supplemental hubs mounted on the remaining four free sides of the gearbox. All of the multiple additional options are illustrated in the chart. Please note that the addition of four supplemental hubs, determines approximately a 40% reduction of Efficiency and approximately a 60% reduction of the max thermal power.

Ratio	RX / RZ
1/1,5	S30
1/2	S30
1/3	S30
1/4	S30

GV Viton Seals



> Specifications



AGV Viton Seals are used in cases of high temperature environments or when seals are subjected to high friction and consequent rising of temperatures. GV Viton seals are recommended in those applications with temperatures exceeding 80 ° C (176 ° F) and can operate up to a maximum of 200 ° C (392 ° F)

MV Top Vertical Hub

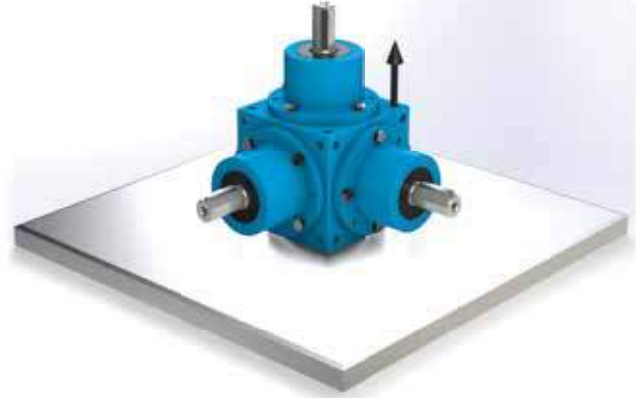

> Specifications



In those applications where one of the hubs is located vertically on the top face of the gearbox, gravity may cause insufficient lubricant irrigation on the top bearings and determine a premature wear of

the unit. The use of a special MV Top Vertical Hub, with a separate sealed chamber filled with grease rather than gear oil, guarantees consistent performance and reliability over time.

NLY Niploy Coating Treatment



> Specifications



The NLY Niploy-Coating Treatment is a patented chemical-nickel coating used to enhance the resistance to corrosion and other aggressive agents of the non-moving parts of Screw Jacks, Bevel Gear Reducers and Speed Modulators.

RE High Reduction Bevel Gearboxes



> Specifications



The RE Series is a high reduction bevel gear equipped with a planetary 1/3 input reduction. The 2-stage reduction allows 1/3, 1/4.5, 1/6, 1/9 and 1/12 ratios.

RIS Inverter Bevel Gearbox



> Specifications



The RIS Series is a special bevel gear reducer equipped with a manual selector to change the direction of the transmission; three modes are available: clockwise, counterclockwise and neutral. The selector can only be operated when the bevel gear is not running.

RH Multiplier Bevel Gearboxes

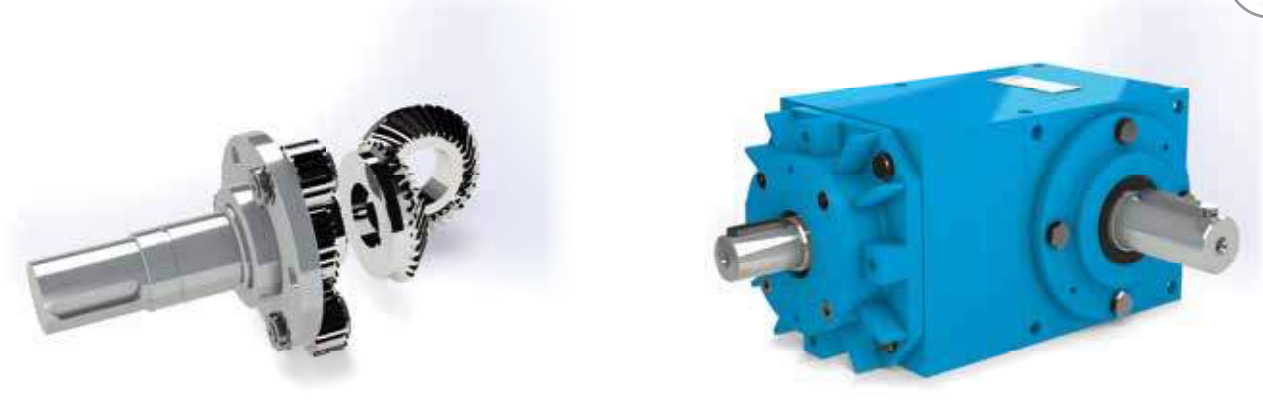

> Specifications



The RH Series is a multiplier bevel gear equipped with a planetary 3/1 input transmission. The 2-stage configuration allows 4.5/1, 3/1 and 2/1 multiplying ratios depending on the size of the unit.

VE Epoxy Painting

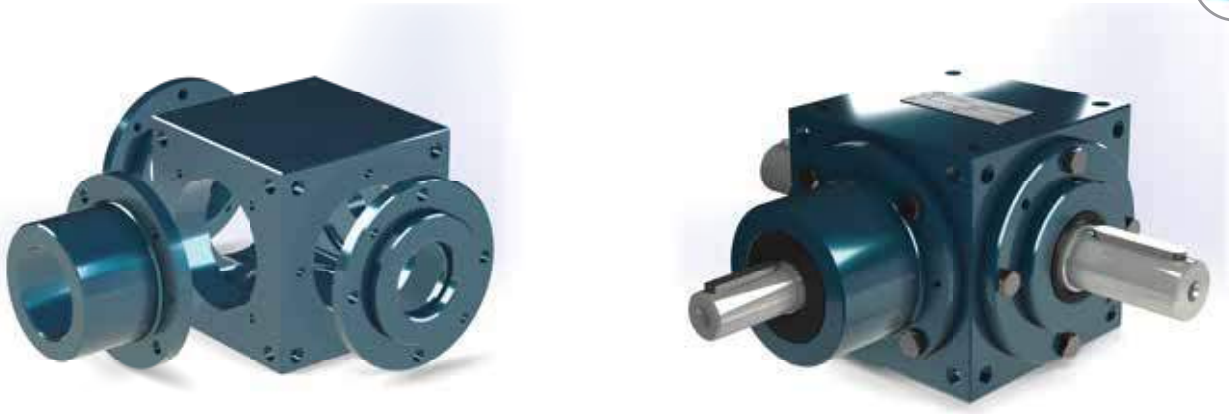

> Specifications



The VE Epoxy Painting is an optional painting based on a 3-stage process: stage 1 is a primer coat; stage 2 is a neutral coat base; stage 3 is the final color-coded coat. The end-result is aesthetically pleasant, with a rich gloss finish and improved resistance to

oxidation. Our epoxy painting is water-based and solvent-free and can be obtained in our standard RAL 5015 (Sky Blue) color. Custom colors may be obtained upon request.

Constructive forms

In all constructive forms it's possible to assemble a motor flange in the positions indicated by the letter "m".

> RC - RR - RB - RA

Ratio:
1/1

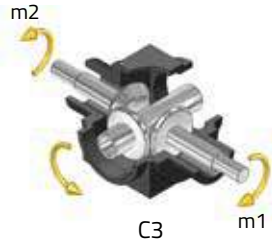

> RS - RP

Ratio:
1/1

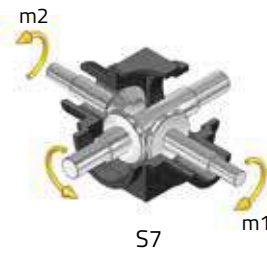
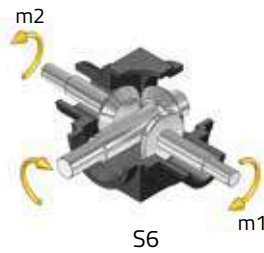
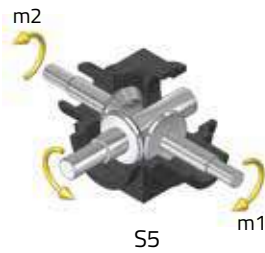

> RX - RZ

Ratio:
1/1

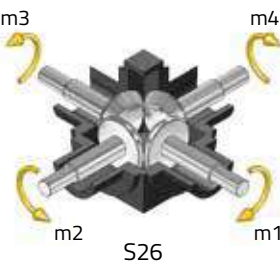
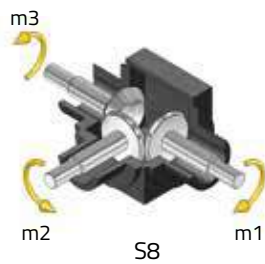

> RC - RB - RA

Ratio:
1/1,5 - 1/2
1/3 - 1/4

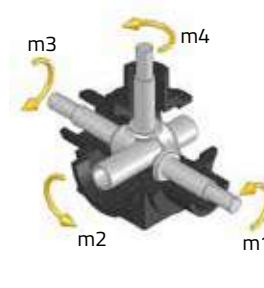
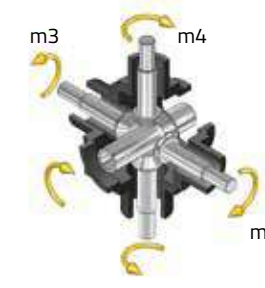
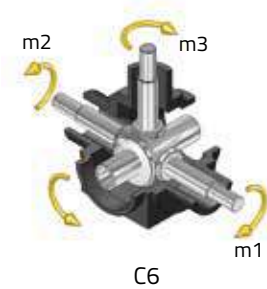
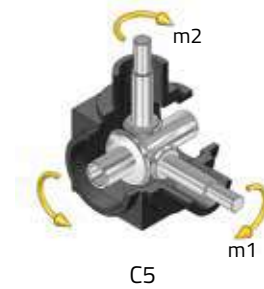
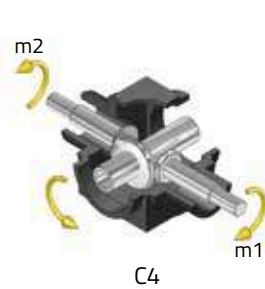

› RS - RP

Ratio:
1/1,5 - 1/2
1/3 - 1/4

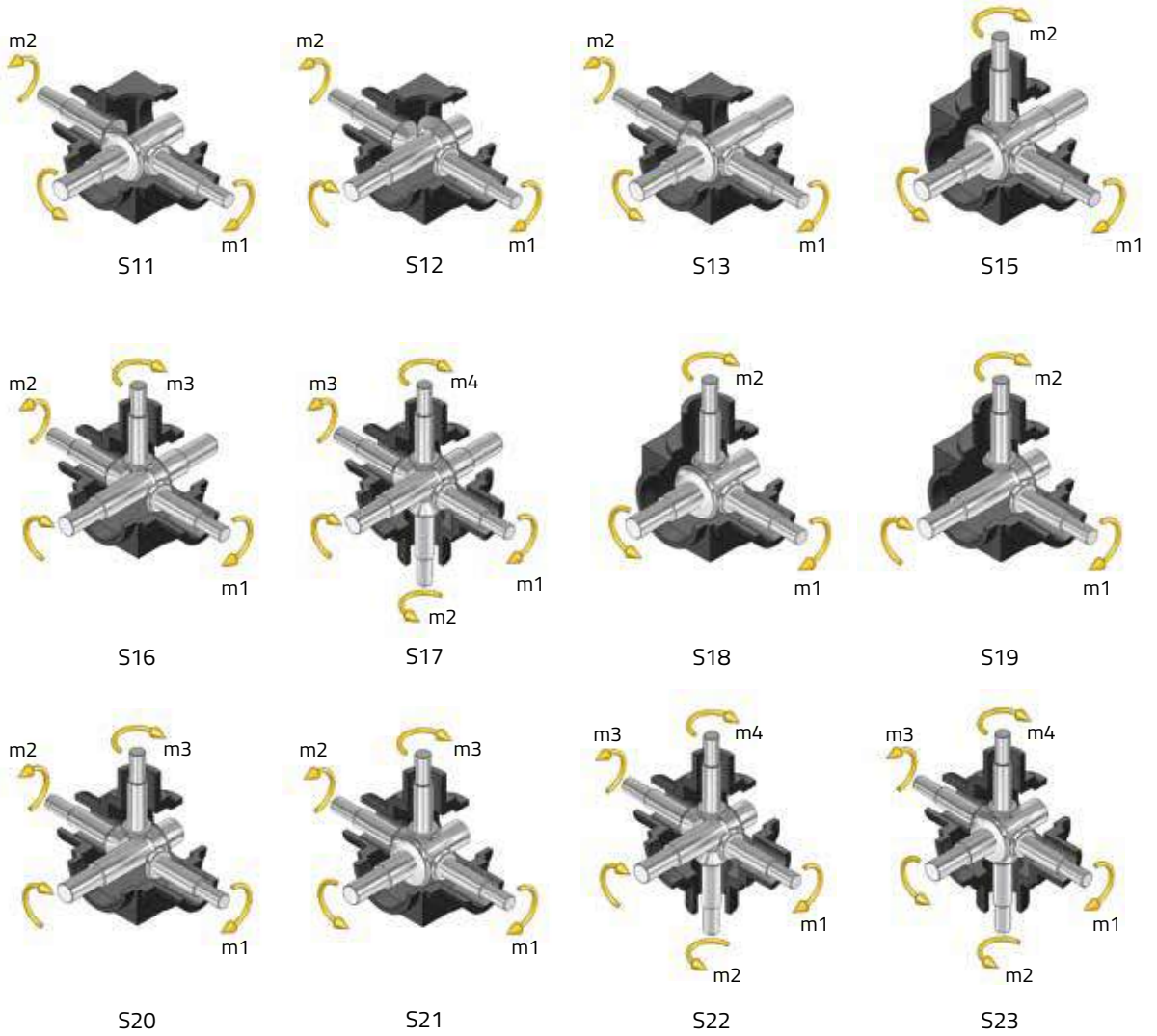

› RX - RZ

Ratio:
1/1,5 - 1/2
1/3 - 1/4

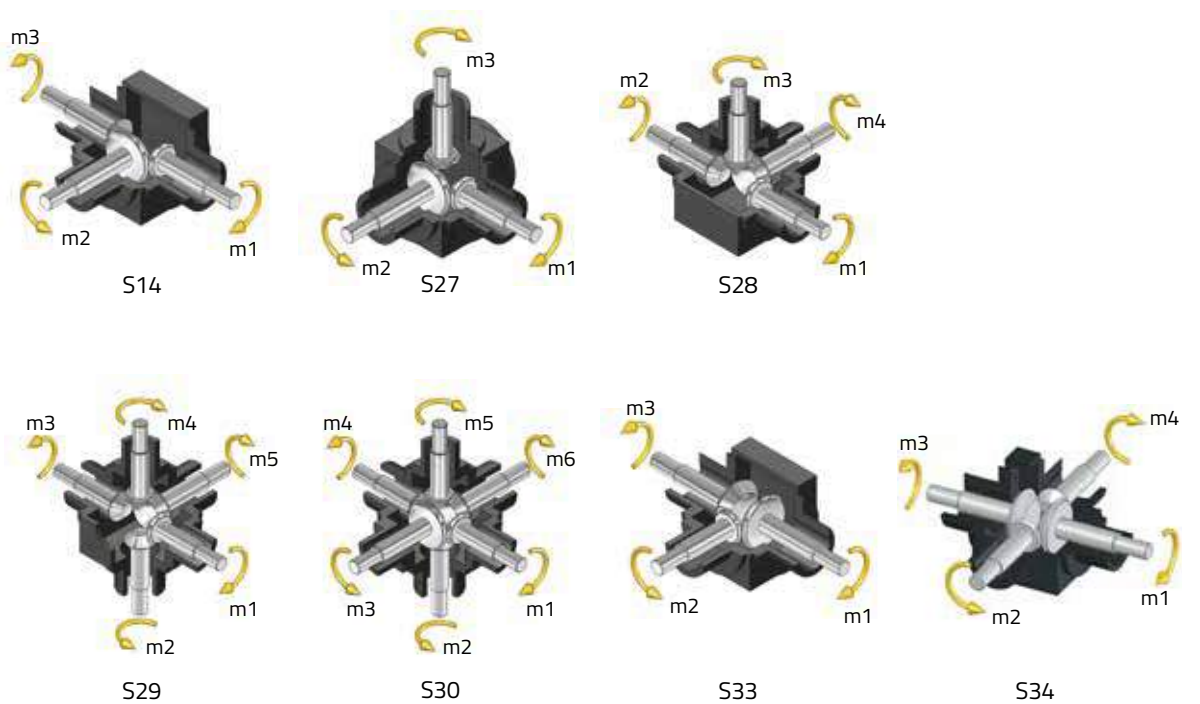

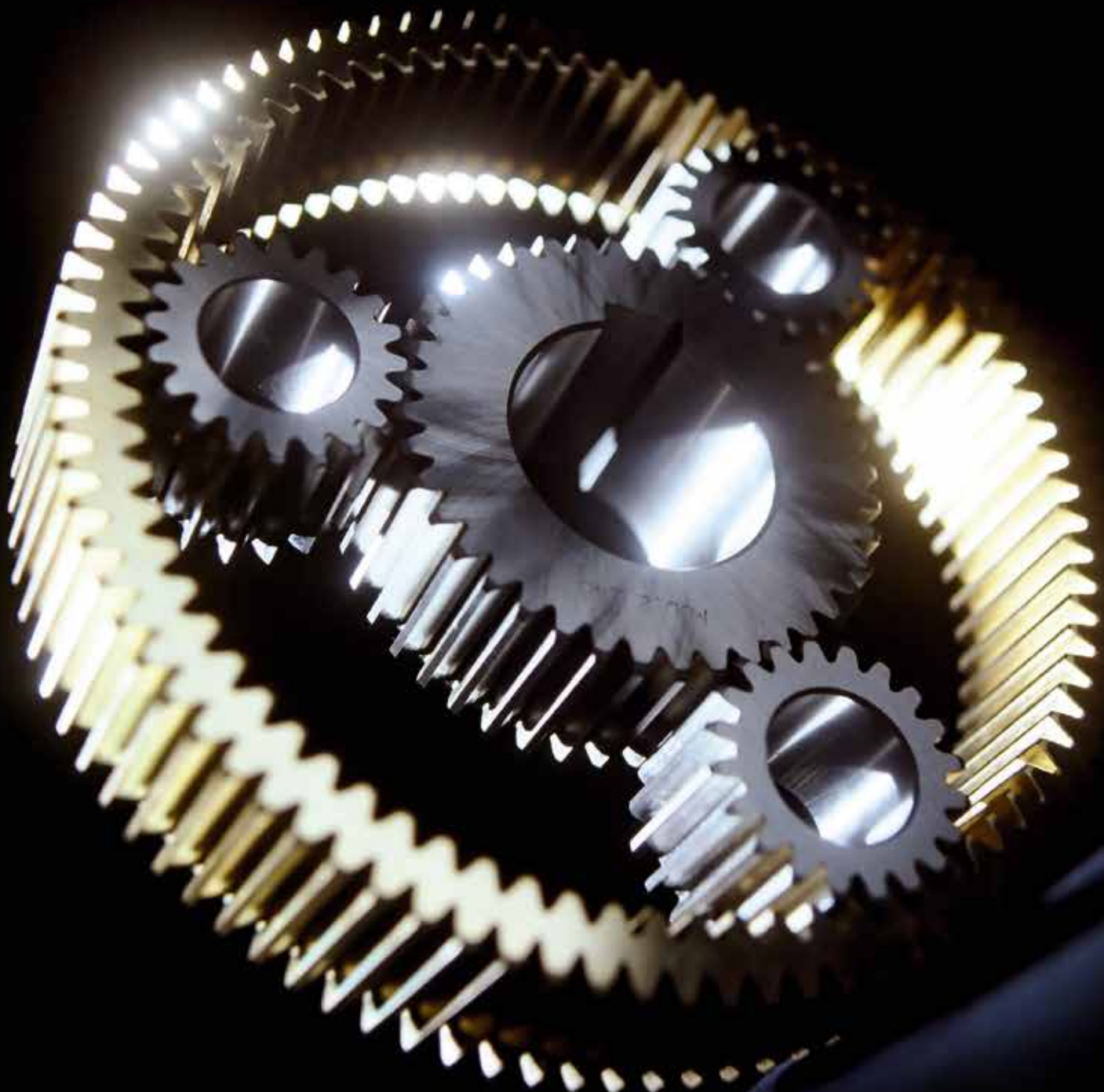

Mechanical Speed Modulators

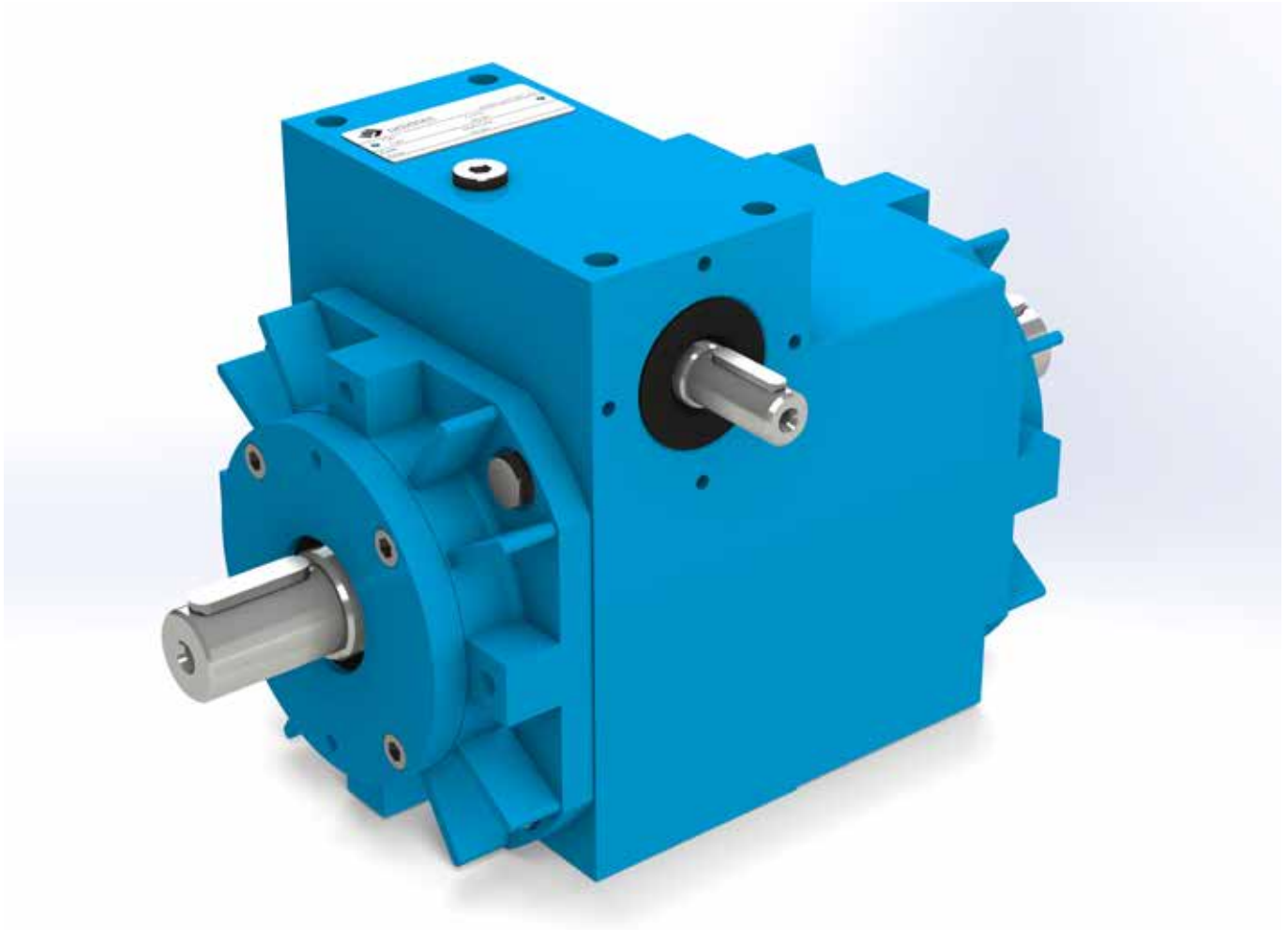

The purpose of a speed modulation gearbox is the possibility to increase or decrease the revolution speed by means of a temporary additional rotation.

Said operation is effected manually, with motors or motor reducers, through a worm screw having a high reduction ratio. The angular speed adjustment can also be performed when the machine is running, by overlapping the effects of the different handlings and thus reducing the expensive non-working periods. The operation principle of UNIMEC's speed modulation gearboxes is the same as the planetary gearboxes, the only difference being the external ring gear, is not connected to the body, but is contrasted by an adjustment worm screw. Rotating this device, and as a consequence rotating the planetary system too, it is possible to modify the transmission output revolution speed. Machines made of various working stations, with conveyor belts and feeding lines (typical of the paper, packaging and press sectors, etc.) find

their ideal solution in the speed modulation gears, in order to synchronize the various delivery phases.

Speed modulation gearboxes can also be used as non-stop speed modulators. It is therefore possible, in case for example of coiling lines, to modify the speed of one or more stations in order to obtain constant pulls. Other typical applications for speed modulation gearboxes are the press machines, the sheet working machines, the paper and packaging machines, where the control for waste reduction and for the machines setting requires high handling precisions.

3 versions, 5 models and 85 construction forms, mean a wide range of application for a designer. In addition to standard models, UNIMEC is able to provide special custom designed speed modulation gearboxes suited to the requirements of specific machines.



Couplings and Transmission Shafts

To complete its range of production UNIMEC is also able to supply high torsion stiffness blade couplings. They show an absolute torsion rigidity in both rotation directions together with the ability to support high torques.

The resistance to corrosive agents, the absorption of vibrations, the possibility to be used in any temperature conditions and an almost unlimited life, without any kind of maintenance, make of them an excellent product. The UNIMEC couplings manufacturing foresees a completely metallic construction, pressed steel up to size 11 and nodular cast iron for the bigger sizes; the blade series is made of spring steel. UNIMEC couplings are able to absorb axial and parallel movement errors, and can support angular misalignments of $\pm 1^\circ$.

Nowadays blade couplings aren't anymore able to satisfy customer's needs. UNIMEC signed a long partnership with a leader constructor in couplings and transmission shafts: R+W. Both technical offices are in connection and, as consequence, UNIMEC is autonomous in dimensioning. Thanks to this magenta cooperation, UNIMEC can supply the complete kinematic transmission, including elastomer and metal couplings, torque limiters, balanced shaft and the complete R+W production.



Lubricants



Unimec lubricants were born because of customer's needs to have oils and greases able to increase performances and lifetime of his plants, also fulfilling guarantee requirements. Thanks to the cooperation with Total two lubricants were born: the MARK CA grease and the ATIR SH150 synthetic oil. These products, safe

for the men and for the environment, are enough for the complete Unimec production. A further step for the customer was to put the grease MARK CA inside an automatic lubrication system made by Perma: in this way it's possible to save time and money making ordinary maintenance easier.

MARK CA -125 ml



Semifluid grease for internal gears and screws



[-25; +150] °C
[-10; +300] °F



Max 1500 rpm



Safe for water and environment



No toxic heavy metals



Not flammable



EP specifications



Safe for users



No transport restrictions *

* ADR / RID / IMDG / IMO / ICAO / IATA / ADN



ATIR SH150 - 500 ml



Synthetic oil for bevels and internal gears, also suitable for high speeds



[-40; +200] °C
[-40; +400] °F



Max 3000 rpm



Safe for water and environment



No toxic heavy metals



Not flammable



EP specifications



Safe for users



No transport restrictions *

* ADR / RID / IMDG / IMO / ICAO / IATA / ADN



NOVA 125 - 125 ml



Gas-expansion automatic lubrication management system with Unimec Mark CA grease



[-20; +60] °C
[-5; +140] °F



ATEX



Lifetime up to 12 months



IP65



CE



Max 6 bar



> Installation

KL1 - Direct installation

KL2 - Remote installation

TPR



TPR



TP



How to order



1m - 3,3 ft



	Control panel	NOVA 125 unit	Mounting bracket	Green tube	Fittings and seals	Grease tube 1	Grease tube 2
KL1	■	■	■	■	■		
KL2	■	■	■	■	■	■	
KL3		■ ■ ■ ■					
KL4						■ ■ ■ ■	
KL5							■ ■
TGM0125						■	
CUN0125		■					
AUN0125	■						
RUN0125			■	■	■		
BOR0500							■



Unimec S.p.A. - Sede Centrale

Via del Lavoro, 20 | 20865 Usmate-Velate (MB) - IT
tel. +39.039.6076900 | fax +39.039.6076909
info@unimec.eu

Unimec Deutschland G.m.b.H.

Pionierstraße 3a | 77694 Kehl - DE
tel. +49.7851.9947780 | fax +49.7851.9947789
info@unimec.de

Unimec France S.a.r.l.

29, Rue des Cayennes - Z. A. Boutries | BP 215 - 78702
Conflans Cedex - FR
tel. +33.1.39196099 | fax +33.1.39193594
info@unimec.fr

Unimec Hispania S.l.

P.I. El Prat C/Ronda de les Conques, 27 | 08180 Moià
(Barcelona) - ES
tel. +34.93.1147067 | fax +34.93.1147068
unimechispania@unimec.eu

Unimec North America Inc.

11 Millpond Drive, Bldg. 2 | 07871 Lafayette, NJ 07848 - USA
tel. +1.800.301.7239 | fax +1.973.362.1497
info@unimec.us

Unimec Triveneto S.r.l.

Via della Tecnica, 10 | 35035 Mestrino (PD) - IT
tel. +39.049.9004977 | fax +39.049.9004524
unimectriveneto@unimec.eu