

16.100

Tungelås uden sikring. Hulafstand: 66 mm. Galvaniseret stål med nylontunge, til 8 mm stift.

Universal budget latch. With nylon bolt, for 8 mm T-key

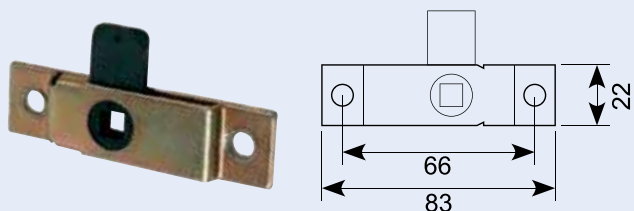

16.100R

Tungelås uden sikring. Rustfri stål, til 8 mm stift.

Stainless steel, for 8 mm T-key

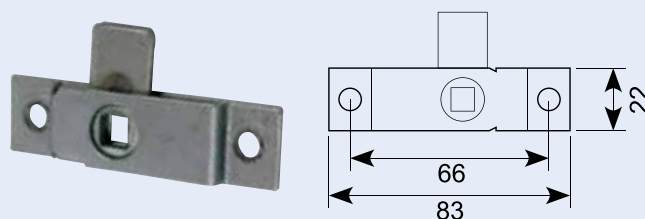

16.100X

Tungelås uden sikring. Galvaniseret stål med ståltunge, til 8 mm stift.

With steel bolt, for 8 mm T-key.

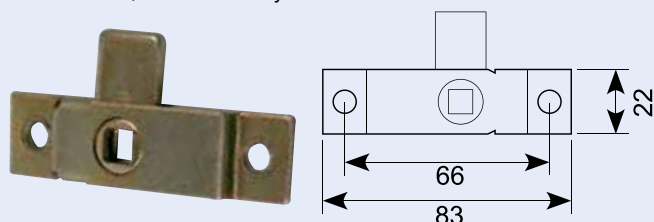

16.102

Tungelås uden sikring. Galvaniseret jern til 8 mm stift.

Latch lock without safety device. Zinc-plated steel, for 8 mm pin.

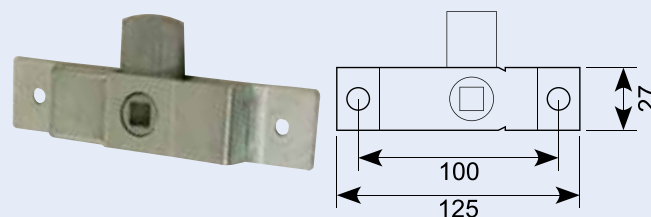

16.103

Tungelås uden sikring - venstre. Zink-plated stål, til 8 mm stift.

Handed budget latch - LH. Zinc-plated, for 8 mm T-key.

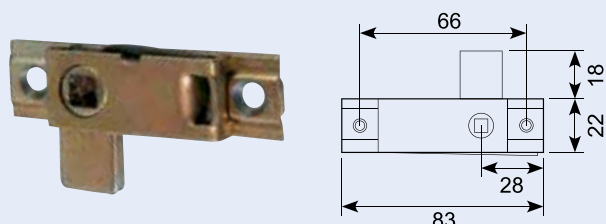

16.104

Tungelås uden sikring - højre. Galvaniseret stål, til 8 mm stift.

Handed budget latch - RH. Zinc-plated, for 8 mm T-key.

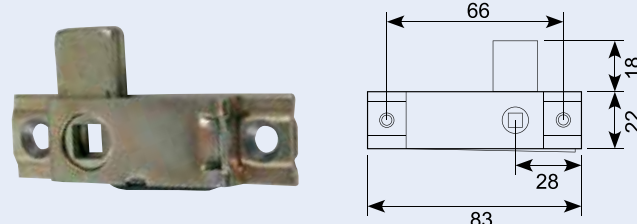

16.179

Hagelås - venstre. Galvaniseret stål, til 8 mm stift

Flush fitting lock - LH. Zinc-plated, for 8 mm pin. Flush fitting lock left.

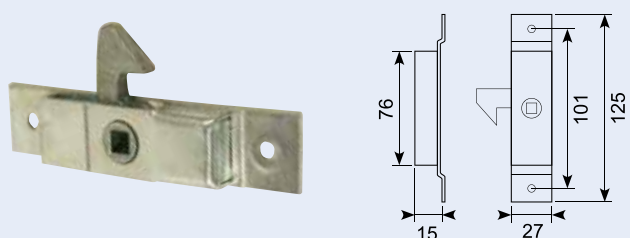

16.180

Hagelås - højre. Galvaniseret stål, til 8 mm stift.

Flush fitting lock - RH. Zinc-plated, for 8 mm pin. Flush fitting lock right.

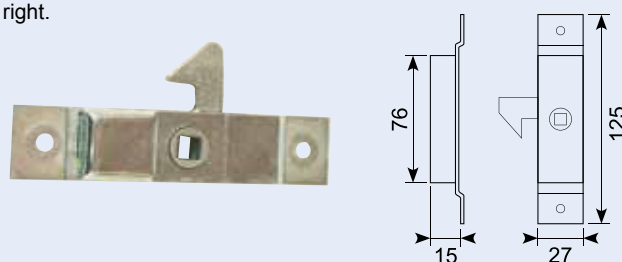

50.064110

Dørlås, galvaniseret. 27 x 125 mm.

Hulafstand: 102 mm

Door lock.

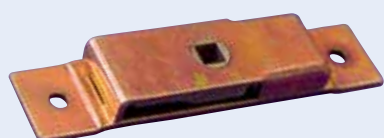

50.064120

Dørlås, galvaniseret og aluminium tunge.

22 x 115 mm. Hulafstand: 94 mm

Door lock.



50.064130

Dørlås, galvaniseret. 19 x 105 mm.

Hulafstand: 86 mm

Door lock.



16.101J **

Dørlås 7mmFK , 19 x 100 mm, Hulafstand 80 mm cent 53+47
4-8micron se osse 16.101JSS

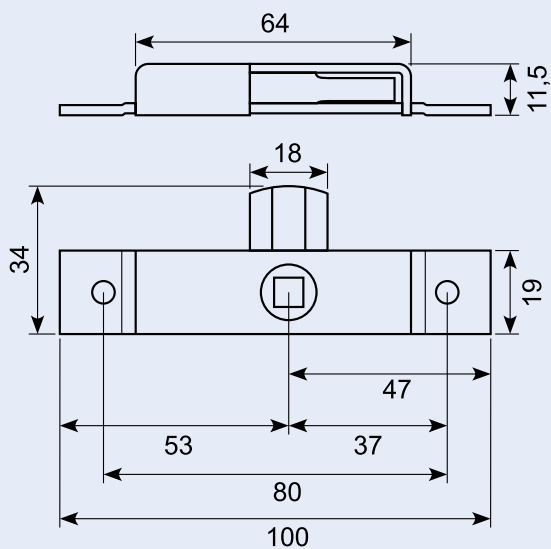
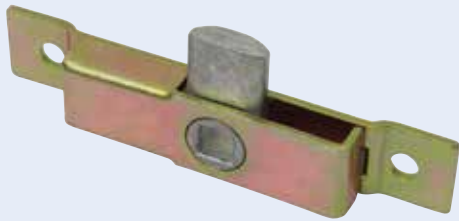

16.101JSS **

Dørlås 7mmFK , 19 x 100 mm, Hulcenter 80 mm center 53+47
Rustfri ss304 +zink cam.

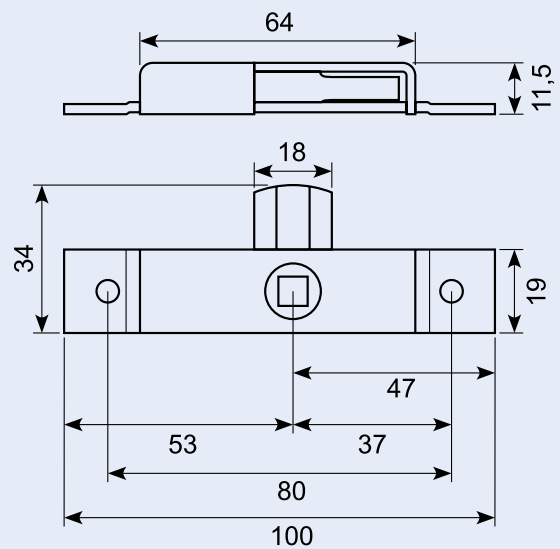

16.205X

Snaplås i galvaniseret stål med omvendt gæk.

Top-knob latch, nose-up mild steel.

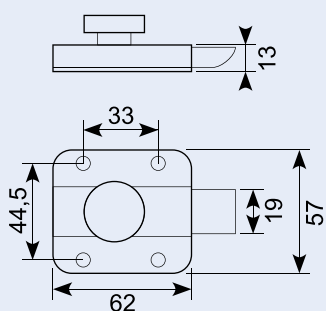
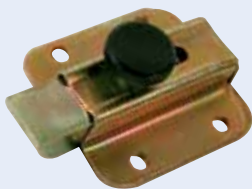

16.205

Snaplås, galvaniseret stål med knop.

Top-knob latch, nose-down. Mild steel.

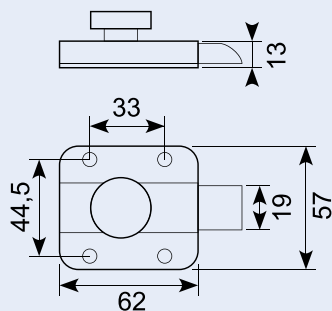
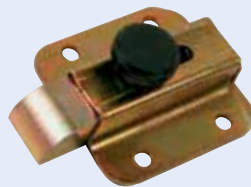

16.205R

Snaplås, rustfrit stål med knop.

Top-knob latch, nose-down SS.

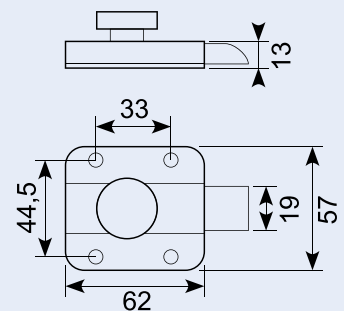
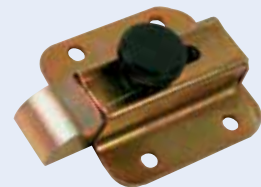

16.316

Sort magnetlås med modblik.
4-5 kg holde kraft.



16.215

Snaplås, metal højre topmonteret. El-galvaniseret jern - til kabel.
Claw latch, RH, top mount. Yellow zinc-plated - for cable.

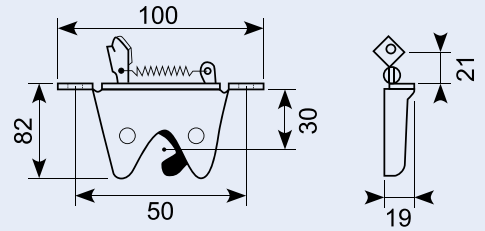

16.216SJ**

Snaplås galv. 67 x 48 mm.

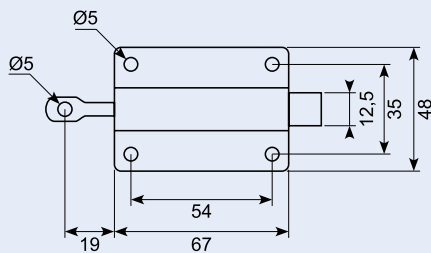

16.213J

Snaplås galvaniseret støbt massiv næse.
Galvanized latch with cast solid nose.

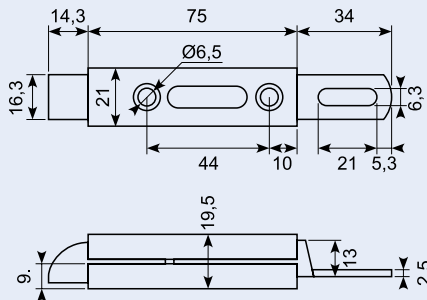

16.203J

Snaplås galvaniseret med krog.
Galvanized latch with hook.

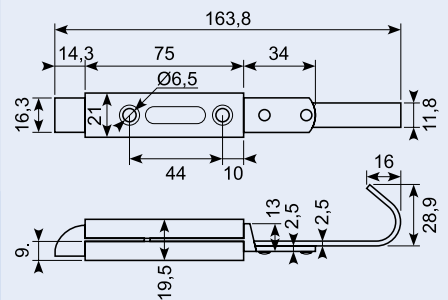

16.214

Snaplås, sort kunststof.
Moulded slam latch, black synthetic material.

