

Gear Motors Group 1, 2 and 3

Technical Information

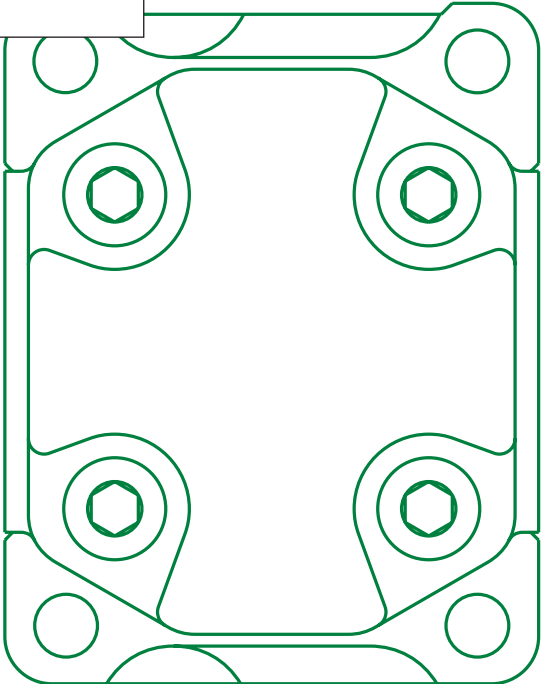
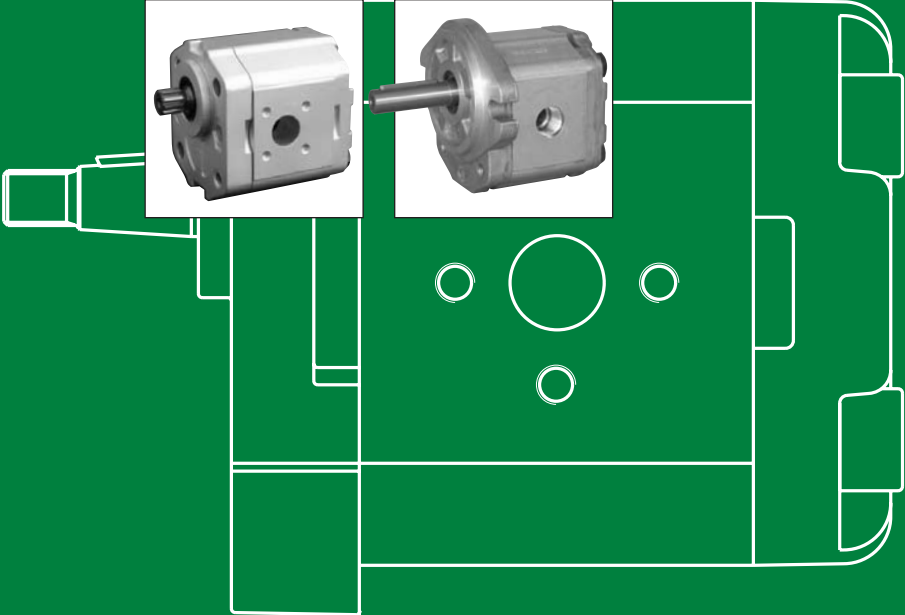
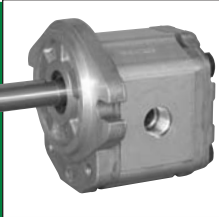
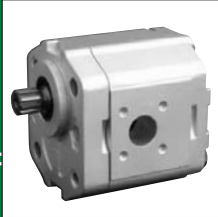
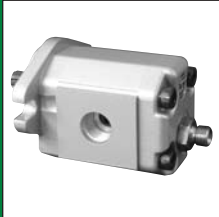
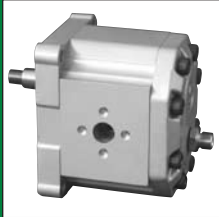
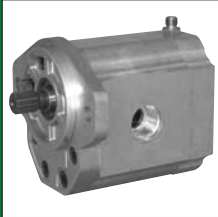
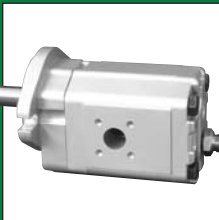
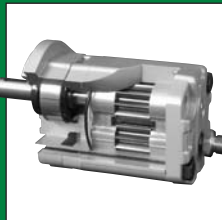

Overview

The Turolla OCG Gear Motors is a range of peak performance fixed displacement hydraulic motors available in three different frame sizes: Group 1, Group 2 and Group 3, all as uni- and bidirectional version.

Constructed of a high strength extruded aluminum body with aluminum rear cover and aluminum front flange, all motors are balanced for exceptional efficiency and designed to ensure an excellent starting torque and, in the bidirectional version, to guarantee the ability to work with high back pressure and extremely low system pressure.

The flexibility of the range in each frame size combined with the high efficiency and low starting torque makes the Turolla OCG Gear Motors ideal for a wide range of applications sectors including on- and off-highway hydraulic fan drive systems, turf care, road bldge, fork lifts and municipal.

All the unidirectional motors have the same construction of the correspondent pump as well but, with inlet and outlet positioned at the opposite side for the same rotation.

Some representatives of gear motors:

SKM1NN 06SA



F005 216

SNM3NN 01BA

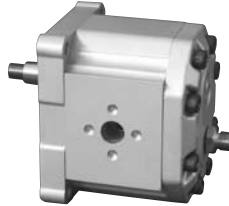

F005 217

SNM3NL 07SA



F005 221

SNM2NN 9JDB



F005 219

SNU2NN 06SA

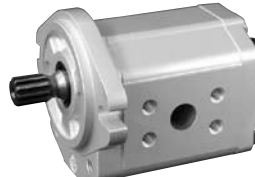

F005 105

SNU2NN 06GA

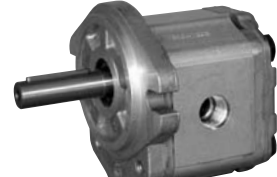

F005 220

© 2010 Turolla OpenCircuitGear™. All rights reserved.

Turolla OCG accepts no responsibility for possible errors in catalogs, brochures and other printed material. Turolla OCG reserves the right to alter its products without prior notice. This also applies to products already ordered provided that such alterations can be made without affecting agreed specifications. All trademarks in this material are properties of their respective owners. Sauer-Danfoss, Turolla, Turolla OpenCircuitGear, Turolla OCG, OpenCircuitGear, Fast Lane and PLUS+1 are trademarks of the Sauer-Danfoss Group.

Front cover illustrations: F005 214, F005 219, F005 221, F005 217, F005 071, F005 216, F005 028, F005 220, F301338 and P005 256..

General Information	Overview	2
	Features and benefits	5
	Motor displacements	5
	Determination of nominal motor sizes	6
	Based on SI units/Based on US units.....	6
System Requirements	Pressure.....	7
	Speed.....	7
	Hydraulic fluids	8
	Temperature and viscosity.....	8
	Filtration.....	9
	Reservoir	9
	Filters.....	9
	Selecting a filter.....	9
	Line sizing	10
	Motor shaft connection	10
	Motor shaft load data form.....	11
	Motor life	12
Group 1 General Information	Motor design.....	13
	SKM1NN	13
	SKU1NN	13
	SNU1NN.....	13
	Technical data.....	14
Product Ordering	Model code.....	15
Motor Performance	Motor performance graphs	17
Product Options	Flange, shaft and port configurations	19
	Mounting flanges options.....	20
	Shaft options.....	20
	Port configurations.....	21
	Bidirectional motor ports	22
	Unidirectional motor ports.....	22
Dimensions	SKM1NN, SKU1NN, SNU1NN – 01BA	23
	SKM1NN, SKU1NN – 02BB, 02FA	24
	SKM1NN, SKU1NN – 06GA and 06SA	25
Group 2 General Information	Motor design.....	26
	SNM2NN.....	26
	SNU2NN.....	26
	SKU2NN	26
	Technical data.....	27
Product Ordering	Model code.....	28
Motor Performance	Motor performance graphs	31

Product Options	Flange, shaft and port configurations	33
	Mounting flanges options.....	34
	Shaft options.....	34
	Port configurations.....	35
	Bidirectional motor ports	36
	Unidirectional motor ports.....	36
	Integral relief valve – SNM2IN.....	37
	Variant codes for ordering integral relief valve.....	37
	Integral relief valve and Anti-cavitation check valve – SNM2JN	38
	Outrigger bearing assembly – SNM2NN.....	39
	Dimensions	41
Dimensions	SNM2NN, SNU2NN – 01DA, 01FA and 01BA.....	43
	SNM2NN, SNU2NN – 02DB and 02AA.....	44
	SNM2NN, SNU2NN – 03CA.....	45
	SNM2NN, SNU2NN–04DB/05DB and 04AA/05AA.....	46
	SNM2NN, SNU2NN, SKU2NN – 06SA, 06GA.....	47
Group 3 General Information	Motor design.....	48
	SNM3NN.....	48
	SNU3NN.....	48
	Technical data.....	49
Product Ordering	Model code.....	50
Motor Performance	Motor performance graphs	53
Product Options	Flange, shaft and port configurations	56
	Shaft and flange availability	57
	Shaft and flange availability and torque capability.....	57
	Bidirectional motor ports	58
	Unidirectional motor ports.....	59
Dimensions	SNM3NN, SNU3NN – 01FA, 01DA and 01BA.....	62
	SNM3NN, SNU3NN – 02FA, 02DB and 02AA.....	63
	SNM3NN, SNU3NN – 03FB and 03BB	64
	SNM3NN, SNU3NN – 06AA	65
	SNM3NN, SNU3NN – 07BC, 07SA and 07GA.....	66

Features and benefits

- Three groups of frame sizes (Group 1, 2 and 3)
- Displacements from 2.6 to 90 cm³/rev [from 0.158 to 5.49 in³/rev]
- Available in uni- and bidirectional version for all the frame sizes, displacements and configurations
- Rated pressure up to 250 bar [3625 psi]
- Back pressure capability up to 250 bar [3625 psi]
- Speeds up to 4000 min⁻¹ (rpm) for Group 1 and 2, and up to 2500 min⁻¹ (rpm) for Group 3
- SAE, ISO and DIN mounting flanges and shafts
- Available with integrated relief valve in the Group 2 frame size and integrated anti-cavitation valve in Group 2 and Group 3 frame sizes.

Motor displacements

Quick reference chart for unidirectional motor models (Group 1, 2 and 3)

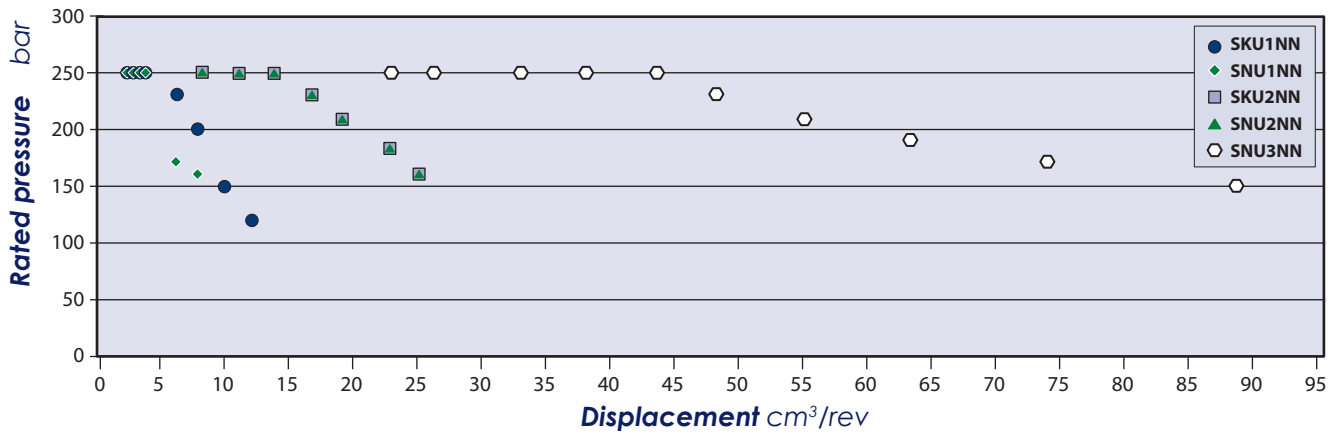

Quick reference chart for bidirectional motor models (Group 1, 2 and 3)

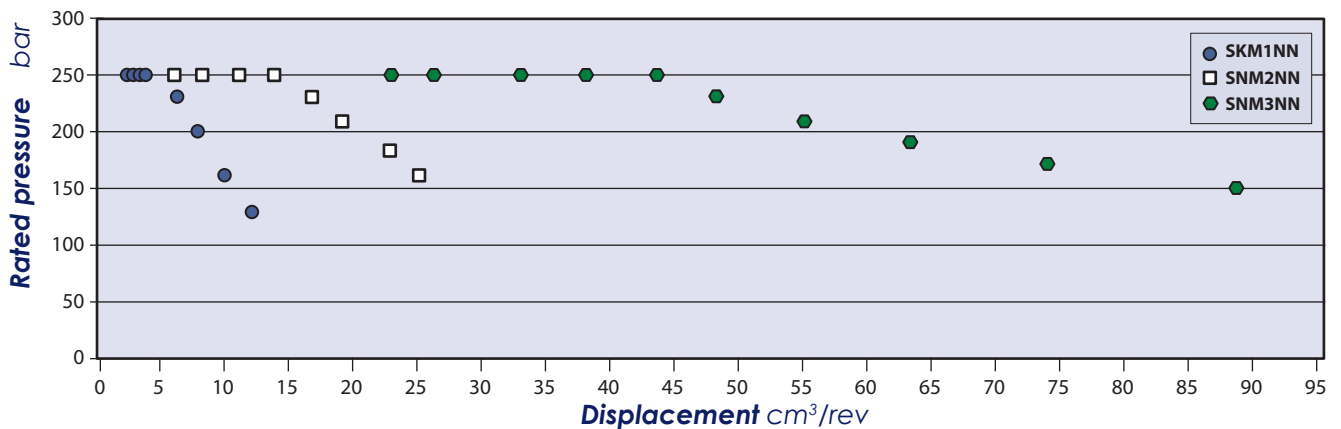

P005 400E

Determination of nominal motor sizes

Use these formulas to determine the nominal motor size for a specific application.

Based on SI units

$$\text{Input flow: } Q = \frac{V_g \cdot n}{1000 \cdot \eta_v} \quad \text{l/min}$$

$$\text{Output torque: } M = \frac{V_g \cdot \Delta p \cdot \eta_m}{20 \cdot \pi} \quad \text{N}\cdot\text{m}$$

$$\text{Output power: } P = \frac{M \cdot n}{9550} = \frac{Q \cdot \Delta p \cdot \eta_t}{600} \quad \text{kW}$$

Based on US units

$$Q = \frac{V_g \cdot n}{231 \cdot \eta_v} \quad \text{[US gal/min]}$$

$$M = \frac{V_g \cdot \Delta p \cdot \eta_m}{2 \cdot \pi} \quad \text{[lb}\cdot\text{ft}\cdot\text{in]}$$

$$P = \frac{M \cdot n}{63\,025} = \frac{Q \cdot \Delta p \cdot \eta_t}{1714} \quad \text{[hp]}$$

Variables SI units [US units]

V_g	= Displacement per revolution	cm^3/rev [in^3/rev]
p_o	= Outlet pressure	bar [psi]
p_i	= Inlet pressure	bar [psi]
Δp	= $p_o - p_i$ (system pressure)	bar [psi]
n	= Speed	min^{-1} (rpm)
η_v	= Volumetric efficiency	
η_m	= Mechanical efficiency	
η_t	= Overall efficiency ($\eta_v \cdot \eta_m$)	

Pressure

Peak pressure is the highest intermittent pressure allowed. The relief valve overshoot (reaction time) determines peak pressure. It is assumed to occur for less than 100 ms. The illustration to the right shows peak pressure in relation to rated pressure and reaction time (100 ms maximum).

Rated pressure is the average, regularly occurring operating inlet pressure that should yield satisfactory product life. The maximum machine load at the motor shaft determines rated pressure.

Time versus pressure

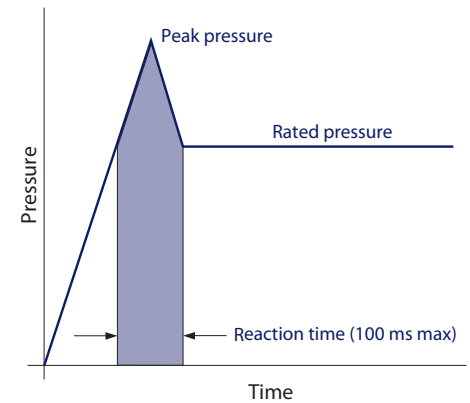

P005 006E

System pressure is the differential between the inlet and outlet ports. It is a dominant operating variable affecting hydraulic unit life. High system pressure, resulting from high load at the motor shaft, reduces expected life. System pressure must remain at, or below, rated pressure during normal operation to achieve expected life.

Back pressure is the average, regularly occurring operating outlet pressure that should yield satisfactory bidirectional motor life. The hydraulic load demand downstream of the motor determines the back pressure. Unidirectional motors cannot work with back pressure and the maximum back pressure allowed is 5 bar [72 psi] rated and 7 bar [101 psi] as peak.

Case Drain Pressure is the regularly occurring case drain line pressure that should yield satisfactory bidirectional motor life. It is recommended to design the case drain piping connecting the case drain direct to the tank in order to keep the case drain pressure as low as possible. The max continuous case drain pressure allowed is 5 bar [72 psi] rated and 7 bar [101 psi] as peak.

Speed

Maximum speed is the limit recommended by Turolia OCG for a particular gear motor when operating at rated pressure. It is the highest speed at which normal life can be expected.

The lower limit of operating speed is the **minimum speed**. It is the lowest speed at which normal life can be expected. The minimum speed increases as operating system pressure increases. When operating under higher pressures, a higher minimum speed must be maintained, as illustrated to the right.

Speed versus pressure

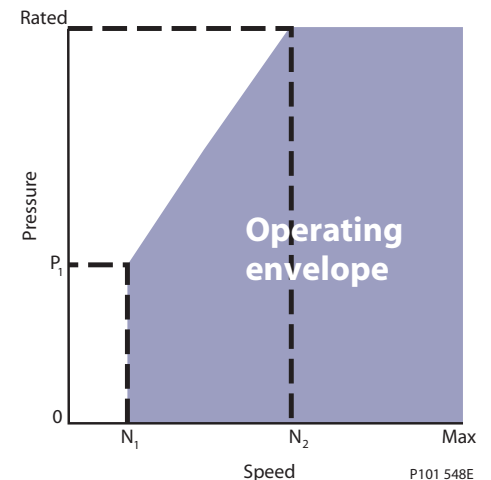

P101 548E

N_1 = minimum speed at low pressure
 N_2 = minimum speed at rated pressure

P101 548E

Gear Motors • Group 1, 2 and 3

Technical Information

System Requirements

Hydraulic fluids

Ratings and data for gear motors are based on operating with premium hydraulic fluids containing oxidation, rust, and foam inhibitors. These fluids must possess good thermal and hydrolytic stability to prevent wear, erosion, and corrosion of internal components. They include:

- Hydraulic fluids following DIN 51524, part 2 (HLP) and part 3 (HVLP) specifications
- API CD engine oils conforming to SAE J183
- M2C33F or G automatic transmission fluids
- Certain agricultural tractor fluids

Use only clean fluid in the motor and hydraulic circuit.

! Caution

Never mix hydraulic fluids.

Please see Turolla OCG publication *Hydraulic Fluids and Lubricants Technical Information, 520L0463* for more information. Refer to publication *Experience with Biodegradable Hydraulic Fluids Technical Information, 520L0465* for information relating to biodegradable fluids.

Temperature and viscosity

Temperature and viscosity requirements must be concurrently satisfied. Use petroleum/mineral-based fluids.

High temperature limits apply at the inlet port of the motor. The motor should run at or below the maximum continuous temperature. The peak temperature is based on material properties. Don't exceed it.

Cold oil, generally, doesn't affect the durability of motor components. It may affect the ability of oil to flow and transmit power. For this reason, keep the temperature at 16°C [60 °F] above the pour point of the hydraulic fluid.

Minimum (cold start) temperature relates to the physical properties of component materials.

Minimum viscosity occurs only during brief occasions of maximum ambient temperature and severe duty cycle operation. You will encounter maximum viscosity only at cold start. During this condition, limit speeds until the system warms up. Size heat exchangers to keep the fluid within these limits. Test regularly to verify that these temperatures and viscosity limits aren't exceeded. For maximum unit efficiency and bearing life, keep the fluid viscosity in the recommended viscosity range.

Fluid viscosity

Maximum (cold start)	mm ² /s [SUS]	1000 [4600]
Recommended range		12-60 [66-290]
Minimum		10 [60]

Temperature

Minimum (cold start)	°C [°F]	-20 [-4]
Maximum continuous		80 [176]
Peak (intermittent)		90 [194]

Filtration

Filters

Use a filter that conforms to Class 22/18/13 of ISO 4406 (or better). It may be on the motor outlet (discharge filtration) or inlet (pressure filtration).

Selecting a filter

When selecting a filter, please consider:

- contaminant ingress rate (determined by factors such as the number of actuators used in the system)
- generation of contaminants in the system
- required fluid cleanliness
- desired maintenance interval
- filtration requirements of other system components

Measure filter efficiency with a Beta ratio (β_x):

- for discharge filtration with controlled reservoir ingress, use a $\beta_{35-45} = 75$ filter
- for pressure filtration, use a filtration with an efficiency of $\beta_{10} = 75$

β_x ratio is a measure of filter efficiency defined by ISO 4572. It is the ratio of the number of particles greater than a given diameter (" x " in microns) upstream of the filter to the number of these particles downstream of the filter.

Fluid cleanliness level and β_x ratio

Fluid cleanliness level (per ISO 4406)	Class 22/18/13 or better
β_x ratio (discharge filtration)	$\beta_{35-45} = 75$ and $\beta_{10} = 2$
β_x ratio (pressure filtration)	$\beta_{10} = 75$
Recommended inlet screen size	100 – 125 μm [0.0039 – 0.0049 in]

The filtration requirements for each system are unique. Evaluate filtration system capacity by monitoring and testing prototypes.

Reservoir

The **reservoir** provides clean fluid, dissipates heat, removes entrained air, and allows for fluid volume changes associated with fluid expansion and during all system operating modes. A correctly sized reservoir accommodates maximum volume changes during all system operating modes. It promotes deaeration of the fluid as it passes through, and accommodates a fluid dwell-time between 60 and 180 seconds, allowing entrained air to escape.

Minimum reservoir capacity depends on the volume required to cool and hold the oil, allowing for expansion due to temperature changes. A fluid volume of one to three times the motor output flow (per minute) is satisfactory. The minimum reservoir capacity is 125% of the fluid volume.

Put the return-line below the lowest expected fluid level to allow discharge into the reservoir for maximum dwell and efficient deaeration. A baffle (or baffles) between the return and suction lines promotes deaeration and reduces fluid surges.

Line sizing

Choose pipe sizes that accommodate minimum fluid velocity to reduce system noise, pressure drops, and overheating. This maximizes system life and performance. The line velocity should not exceed the values in this table:

Maximum line velocity

Inlet		2.5 [8.2]
Outlet	m/s [ft/sec]	5.0 [16.4]
Return		3.0 [9.8]

Most systems use hydraulic oil containing 10% dissolved air by volume. **Over-aeration** is the result of the flow-line restrictions. These include inadequate pipe sizes, sharp bends, or elbow fittings, causing a reduction of flow line cross sectional area. This problem will not occur if rated speed requirements are maintained, and reservoir size and location are adequate.

Motor shaft connection

Shaft options for gear motors include tapered, splined, parallel or Turolla OCG tang shafts.

Plug-in drives, with a splined shaft, can impose severe radial loads when the mating spline is rigidly supported. Increasing spline clearance does not alleviate this condition.

Use plug-in drives if the concentricity between the mating spline and pilot diameter is within 0.1 mm [0.004 in]. Lubricate the drive by flooding it with oil. A three-piece coupling minimizes radial or thrust shaft loads.

Motor shaft connection

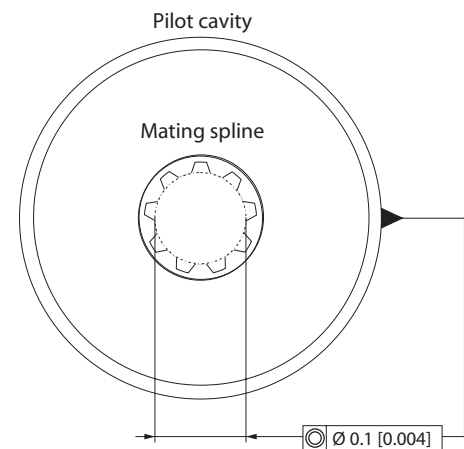

P101 002E

Caution

In order to avoid spline shaft damages it is recommended to use carburised and hardened steel couplings with 80-82 HRA surface hardness.

Allowable **radial shaft loads** are a function of the load position, load orientation, and operating pressure of the hydraulic motor. All external shaft loads have an effect on bearing life, and may affect motor performance.

In applications where external shaft loads can not be avoided, minimize the impact on the motor by optimizing the orientation and magnitude of the load. Avoid thrust loads in either direction. Please contact Turolla OCG, if continuously applied external radial or thrust loads occur.

Gear Motors • Group 1, 2 and 3 Technical Information System Requirements

Motor shaft load data form

Photocopy this page and fax the complete form to your Turolld OCG representative for an assistance. This illustration shows a motor with counterclockwise orientation:

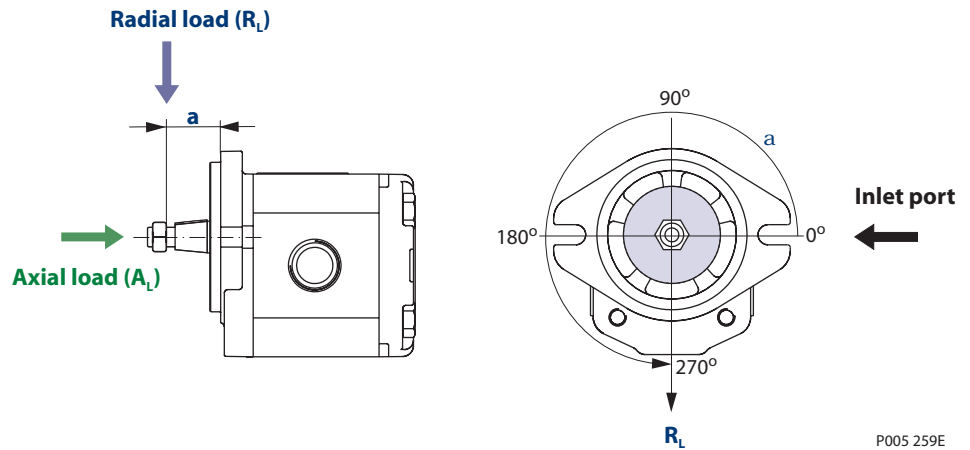

P005 259E

Application data

Item	Value	Based on SI or US units	
Motor displacement		<input type="checkbox"/> cm ³ /rev	<input type="checkbox"/> in ³ /rev
Rated system pressure		<input type="checkbox"/> bar	<input type="checkbox"/> psi
Peak pressure		<input type="checkbox"/> left	<input type="checkbox"/> right
Motor shaft rotation		min ⁻¹ (rpm)	
Motor minimum speed			
Motor maximum speed			
Radial load	R_L	<input type="checkbox"/> N	<input type="checkbox"/> lbf
Angular orientation of radial load to inlet port	α	degree	
Axial load	A_L	<input type="checkbox"/> N	<input type="checkbox"/> lbf
Distance from flange to radial load	a	<input type="checkbox"/> mm	<input type="checkbox"/> in

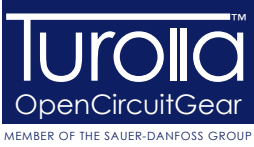

Gear Motors • Group 1, 2 and 3

Technical Information

System Requirements

Motor life

Motor life is a function of speed, system pressure, and other system parameters (such as fluid quality and cleanliness).

All Turolla OCG gear motors use hydrodynamic journal bearings that have an oil film maintained between the gear/shaft and bearing surfaces at all times. If the oil film is sufficiently sustained through proper system maintenance and operating within recommended limits, long life can be expected.

B_{10} life expectancy number is generally associated with rolling element bearings. It does not exist for hydrodynamic bearings.

High pressure impacts motor life. When submitting an application for review, provide machine duty cycle data that includes percentages of time at various loads and speeds. We strongly recommend a prototype testing program to verify operating parameters and their impact on life expectancy before finalizing any system design.

Motor design

SKM1NN

SKM1NN is the Group 1 bidirectional motor available in the whole displacements range from 2.6 up to 12 cm³/rev [from 0.158 up to 0.732 in³/rev]. Configurations include European and SAE flanges and shafts (*Code 01BA, 01DA, 02BB, 02FA, 06GA, 06SA*).



F005 216

SKU1NN

SKU1NN is a Group 1 unidirectional motor available in the whole displacements range from 2.6 up to 12 cm³/rev [from 0.158 up to 0.732 in³/rev]. The SKU1NN motor construction is derived from the correspondent pump SKP1NN. Configurations include European and SAE flanges and shafts (*Code 01BA, 01DA, 02BB, 02FA, 06GA, 06SA*).

SNU1NN

SNU1NN is a Group 1 unidirectional motor available in a limited displacements range from 2.6 up to 7.8 cm³/rev [from 0.158 up to 0.464 in³/rev]. The SNU1NN motor construction is derived from the correspondent pump SNP1NN. Configurations include European flange and shaft (*Code 01BA*).

SNU1NN 01BA (cut-away)

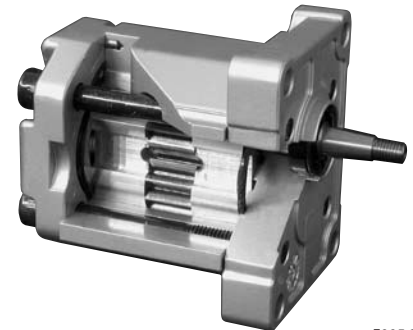

F005 018

Technical data

This table details the technical data for Group 1 gear motors based on the model and displacement configuration.

Technical data for Group 1 gear motors

		Frame size							
		2,6	3,2	3,8	4,3	6,0	7,8	010	012
Displacement	cm ³ /rev [in ³ /rev]	2.62 [0.158]	3.14 [0.195]	3.66 [0.231]	4.19 [0.262]	5.89 [0.366]	7.59 [0.463]	9.94 [0.607]	12 [0.732]
SKM1NN (a standard, bidirectional motor)									
Peak pressure	bar [psi]	270 [3915]	270 [3915]	270 [3915]	270 [3915]	250 [3625]	220 [3190]	180 [2610]	150 [2175]
Rated pressure		250 [3625]	250 [3625]	250 [3625]	250 [3625]	230 [3335]	200 [2900]	160 [2320]	130 [1895]
Back pressure		250 [3625]	250 [3625]	250 [3625]	250 [3625]	230 [3335]	200 [2900]	160 [2320]	130 [1895]
Minimum speed	min ⁻¹ (rpm)	1000	1000	1000	800	800	800	800	800
Maximum speed		4000	4000	3000	3000	2000	2000	2000	2000
SKU1NN (a standard, unidirectional motor)									
Peak pressure	bar [psi]	270 [3915]	270 [3915]	270 [3915]	270 [3915]	250 [3625]	220 [3190]	170 [2465]	140 [2030]
Rated pressure		250 [3625]	250 [3625]	250 [3625]	250 [3625]	230 [3335]	200 [2900]	150 [2175]	120 [1740]
Minimum speed	min ⁻¹ (rpm)	1000	1000	1000	800	800	800	800	800
Maximum speed		4000	4000	3000	3000	2000	2000	2000	2000
SNU1NN (a standard, unidirectional motor)									
Peak pressure	bar [psi]	270 [3915]	270 [3915]	270 [3915]	270 [3915]	190 [2755]	180 [2610]	-	
Rated pressure		250 [3625]	250 [3625]	250 [3625]	250 [3625]	170 [2465]	160 [2320]		
Minimum speed	min ⁻¹ (rpm)	1000	1000	1000	800	800	800		
Maximum speed		4000	4000	3000	3000	2000	2000		
All									
Weight	kg [lb]	1.02 [2.26]	1.14 [2.51]	1.18 [2.60]	1.20 [2.65]	1.30 [2.87]	1.39 [3.06]	1.55 [3.42]	1.65 [3.64]
Moment of inertia of rotating components	x 10 ⁻⁶ kg·m ² [x 10 ⁻⁶ lbf·ft ²]	5.1 [121.0]	5.7 [135.2]	6.4 [151.9]	7.1 [168.5]	9.3 [220.7]	11.4 [270.5]	14.6 [339.4]	17.1 [405.8]

1 kg·m² = 23.68 lb·ft²

⚠ Caution

The rated and peak pressure mentioned are for motors with flanged ports only. When threaded ports are required a de-rated performance has to be considered. To verify the compliance of an high pressure application with a threaded ports pump apply to a Turola OCG representative.

Model code

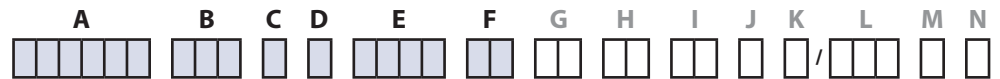

A Type

SKM1NN	Standard bidirectional gear motor
SKU1NN	High torque unidirectional gear motor
SNU1NN	Unidirectional gear motor

B Displacement

2,6	2.62 cm ³ /rev [0.16 in ³ /rev]
3,2	3.14 cm ³ /rev [0.192 in ³ /rev]
3,8	3.66 cm ³ /rev [0.223 in ³ /rev]
4,3	4.19 cm ³ /rev [0.256 in ³ /rev]
6,0	5.89 cm ³ /rev [0.359 in ³ /rev]
7,8	7.59 cm ³ /rev [0.463 in ³ /rev]
010	9.94 cm ³ /rev [0.607 in ³ /rev]
012	12 cm ³ /rev [0.732 in ³ /rev]

C Sense of rotation

R	Right hand (clockwise)
L	Left hand (counterclockwise)
B	Bidirectional

D Version*

N	Standard version
----------	------------------

* value representing a change to the initial project

E Mounting flange and shaft

Code	Description (Type of flange • type of shaft • preferred ports for configuration)	SKM1NN	SKU1NN	SNU1NN
01BA	European 01, 4-bolt flange • Tapered 1:8 shaft • European flanged ports	●	-	●
02BB	European 02, 4-bolt flange • Tapered 1:8 shaft • European flanged ports	●	-	-
02FA	European 02, 4-bolt flange • Parallel shaft • European flanged ports	●	●	-
06GA	SAE A-A flange • Parallel shaft • SAE O-ring boss ports	●	●	-
06SA	SAE A-A flange • SAE splined shaft • SAE O-ring boss ports	●	●	-

F Rear cover

P1	Standard cover for unidirectional motor
M1	Standard cover for motor drain M12x1.5
M2	Cover for motor drain 1/8 GAS
M3	Cover for motor drain 1/4 GAS
M6	Cover for motor drain 7/16-20UNF-2B
MH	Cover for motor drain M12x1.5 ISO6149

Legend:	
●	= Standard
○	= Optional
-	= Not Available

**Model code
(continued)**



G Inlet port*

H Outlet port*

B1	8 x 30 x M6	Flanged port, 4-threaded holes in X pattern, in the center or off-set of the body
B2	13 x 30 x M6	
C1	8 x 26 x M5	Flanged port, 4-threaded holes in + pattern, (European standard ports)
C2	12 x 26 x M5	
C3	13,5 x 30 x M6	
D3	M14 x 1.5	Threaded metric port
D5	M18 x 1.5	
D7	M22 x 1.5	
E3	9/16-18UNF	Threaded SAE O-ring boss port
E4	3/4-16UNF	
E5	7/8-14UNF	
F2	1/4 GAS	Threaded GAS (BSPP) port
F3	3/8 GAS	
F4	1/2 GAS	
H5	M18 x 1.5	Threaded metric port ISO6149
H7	M22 x 1.5	

* For more information see *Port dimensions*, page 22.

I Port position and variant body

NN	Standard gear pump from catalogue
-----------	-----------------------------------

J Sealing

N	Standard Buna seal
H	Back-up ring made for VITON seals
B	VITON seals

K Screws

N	Standard screws
A	Galvanized screws+nuts-washers
B	DACROMET/GEOMET screws

L Set valve

NNN	No valve
V**	Integral RV-Pressure setting. Motor speed for relief valve setting (min ⁻¹ [rpm])

M Marking

N	Standard marking
A	Standard marking + Customer Code
Z	Without marking

N Mark position

N	Standard marking position
A	Mark on the bottom ref. to drive gear

Motor performance graphs

The graphs on the next pages provide typical inlet flow and output power for Group 1 motors at various working pressures. Data were taken using ISO VG46 petroleum / mineral based fluid at 50 °C [122 °F] (viscosity = 28 mm²/s [132 SUS]).

SKM1NN/2,6 motor performance graph

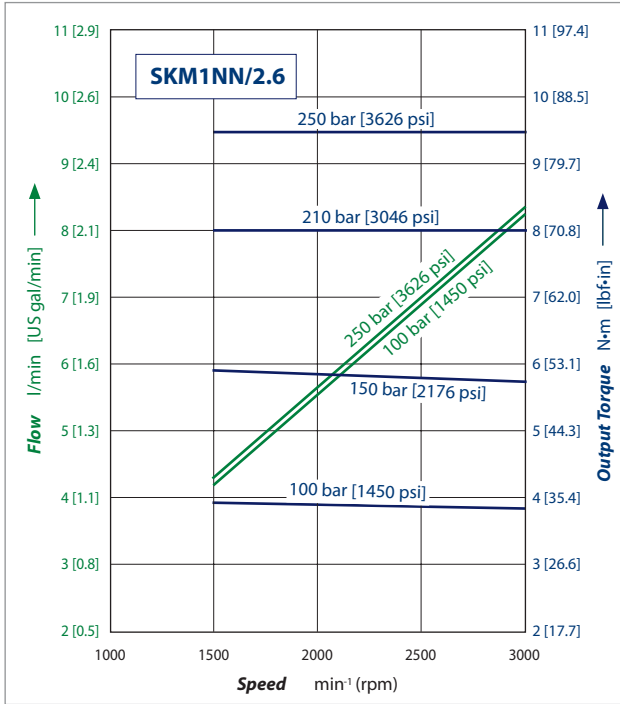

SKM1NN/3,2 motor performance graph

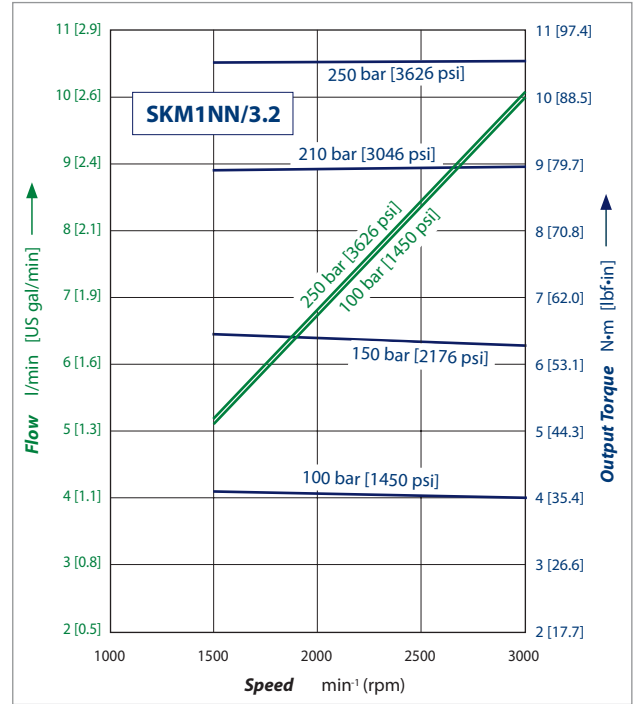

SKM1NN/3,8 motor performance graph

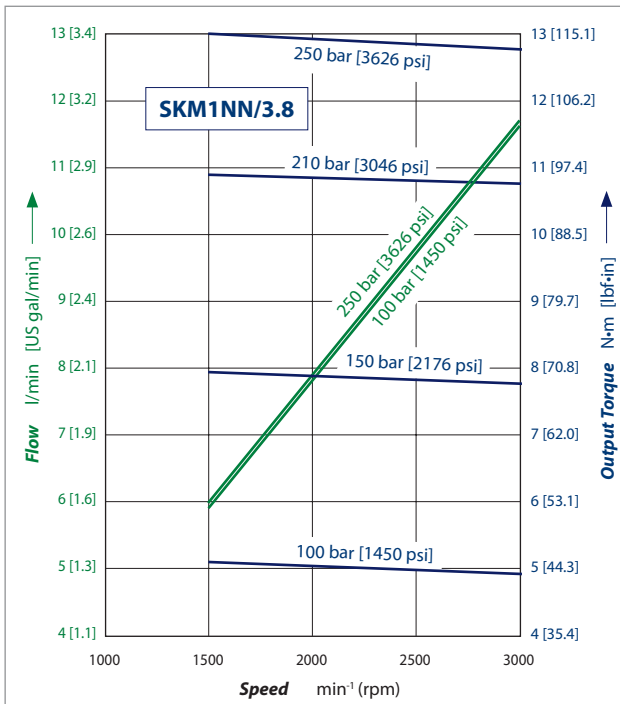

SKM1NN/4,3 motor performance graph

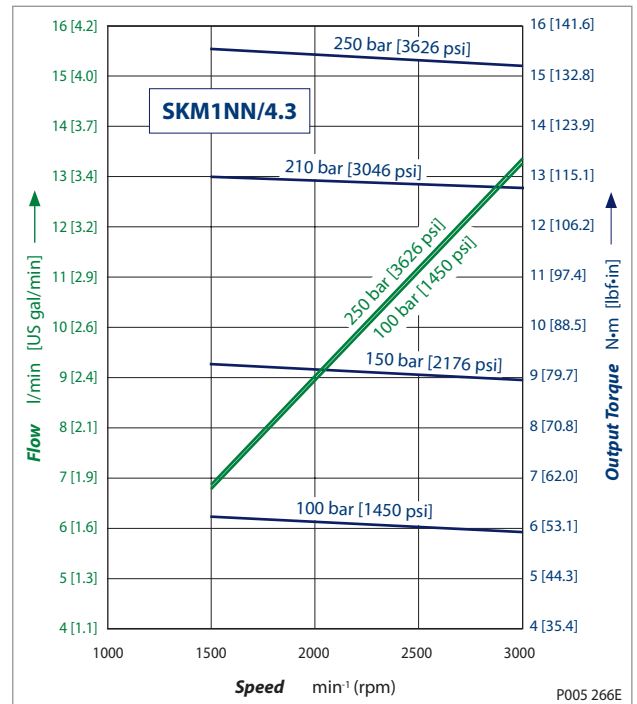

Motor performance graphs (continued)

SKM1NN/6,0 motor performance graph

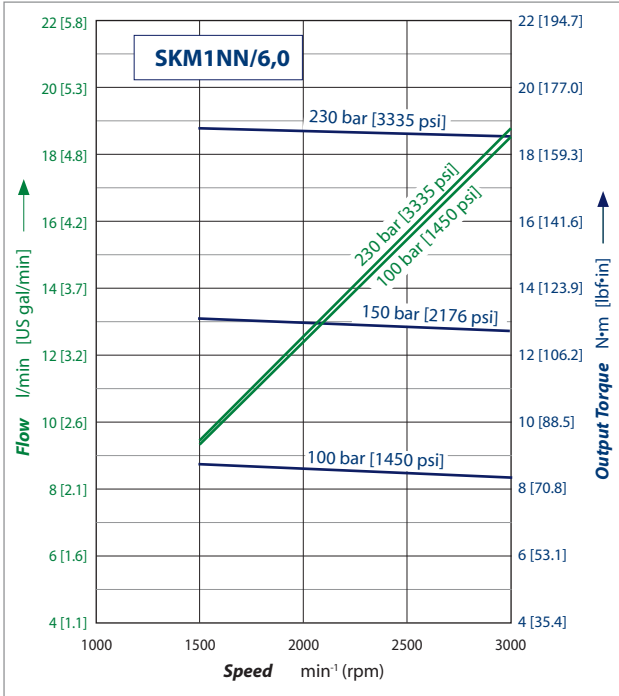

SKM1NN/7,8 motor performance graph

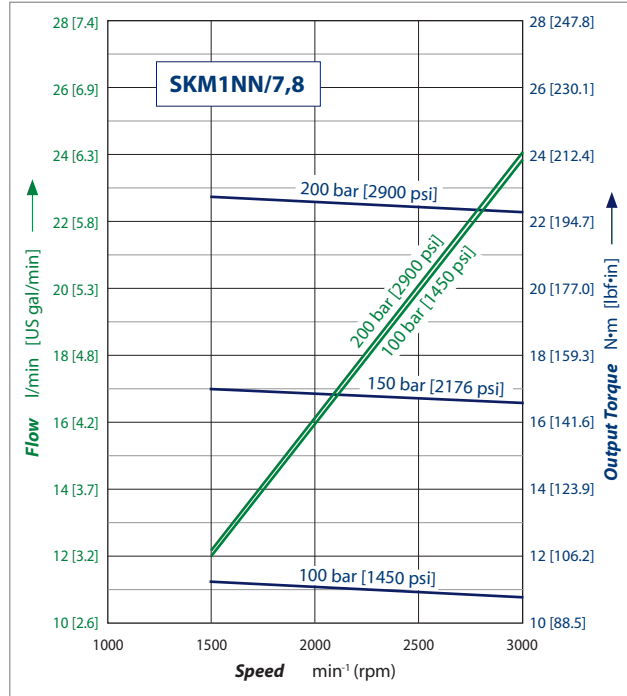

SKM1NN/010 motor performance graph

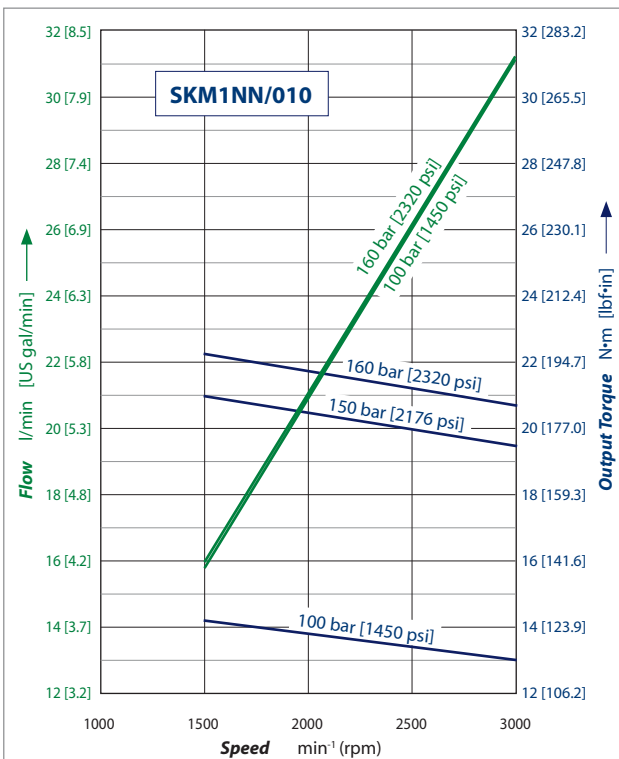



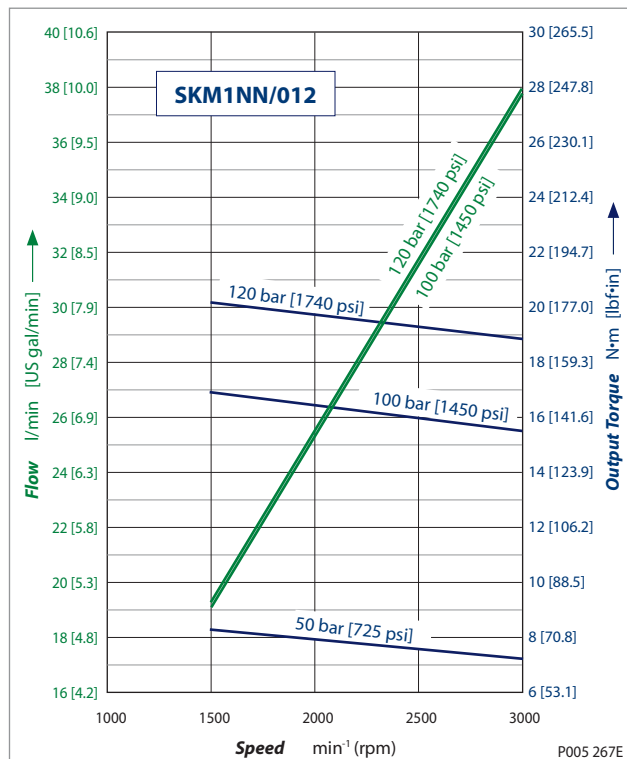

SKM1NN/012 motor performance graph

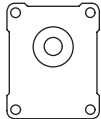
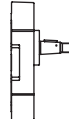
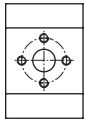
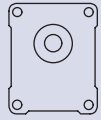
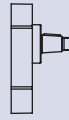
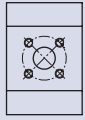
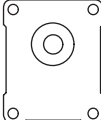
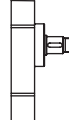
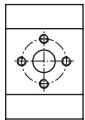
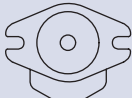

Flange, shaft and port configurations

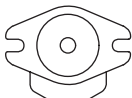
Flange, shaft and port configurations for SKM1NN and SKU1NN motors

Code	Flange	Shaft	Port
01BA	European 01, 4-bolts pilot Ø 25.4 mm [1.0 in] 	Taper 1:8 	European in + pattern 
02BB	European 02, 4-bolts pilot Ø 30 mm [1.181] 	Taper 1:8 	German standard in X pattern 
02FA	European 02, 4-bolts pilot Ø 30 mm [1.181] 	Parallel 12 mm [0.472 in] 	European in + pattern 
06GA	SAE A-A 2-bolts 	Parallel 12.7 mm [0.5 in] 	Threaded SAE O-ring boss 
06SA	SAE A-A 2-bolts 	SAE A-A 9-teeth splined 	Threaded SAE O-ring boss 

Flange, shaft and port configuration for SNU1NN motor

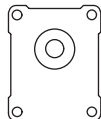
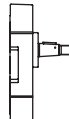
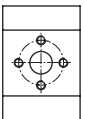
Code	Flange	Shaft	Port
01BA	European 01, 4-bolts pilot Ø 25.4 mm [1.0 in] 	Taper 1:8 	European in + pattern 

Mounting flanges options

Turolla OCG offers many types of industry standard mounting flanges. *The table below shows order codes for each available mounting flange and its intended use*

Flange availability



01	European 25.4 mm [1.0 in] 4-bolt
02	European 30 mm [1.18 in] 4-bolt
06	SAE A-A

Shaft options

Group 1 motors are available with a variety of splined, parallel, and tapered shaft ends. Not all shaft styles are available with all flange styles.

Shaft availability and nominal torque capability



Shaft		Mounting flange code with maximum torque		
Code	Description	01	02	06
BA	Taper 1:8	25 N•m [221 lb•in]	–	–
BB	Taper 1:8	–	50 N•m [442 lb•in]	–
SA	SAE spline J 498-9T-20/40DP	–	–	34 N•m [301 lb•in]
FA	Parallel 12 mm [0.47 in]	–	24 N•m [212 lb•in]	–
GA	Parallel 12.7 mm [0.50 in]	–	–	32 N•m [283 lb•in]

Recommended mating splines for Group 1 splined output shafts should be in accordance with SAE J498 or DIN 5482. Turolla OCG external SAE splines are flat root side fit with circular tooth thickness reduced by 0.127 mm [0.005 in] in respect to class 1 fit. The external DIN splines have an offset increased by 0.1 mm [0.004 in]. These dimensions are modified in order to assure a clearance fit with the mating spline.

Other shaft options may exist. Contact your Turolla OCG representative for availability.

⚠ Caution

Shaft torque capability may limit allowable pressure. Torque ratings assume no external radial loading. Applied torque must not exceed these limits, regardless of stated pressure parameters. Maximum torque ratings are based on shaft torsional fatigue strength.

Port configurations

Various port configurations are available on Group 1 motors. They include:

- European standard flanged ports
- German standard flanged ports
- Gas threaded ports (BSPP)
- O-ring boss (following SAE J1926/1 [ISO 11926-1] UNF threads, standard)

Available port configurations for **Inlet (G)** and **Outlet (H)**

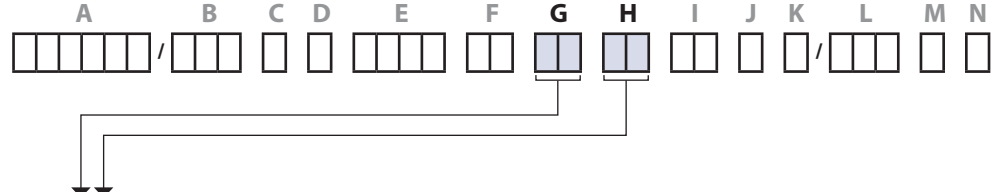

Port		
Code	Dimension	Description
B1	8 x 30 x M6	Flanged port, 4-threaded holes in X pattern, in the center or off-set of the body
B2	13 x 30 x M6	
C1	8 x 26 x M5	Flanged port, 4-threaded holes in + pattern, (European standard ports)
C2	12 x 26 x M5	
C3	13.5 x 30 x M6	
D3	M14 x 1.5	Threaded metric port
D5	M18 x 1.5	
D7	M22 x 1.5	
E3	9/16-18UNF	Threaded SAE O-ring boss port
E4	3/4-16UNF	
E5	7/8-14UNF	
F2	1/4 GAS	Threaded GAS (BSPP) port
F3	3/8 GAS	
F4	1/2 GAS	
H5	M18 x 1.5	Threaded metric port ISO6149
H7	M22 x 1.5	

Ports dimensions

Available ports for Group 1 motors

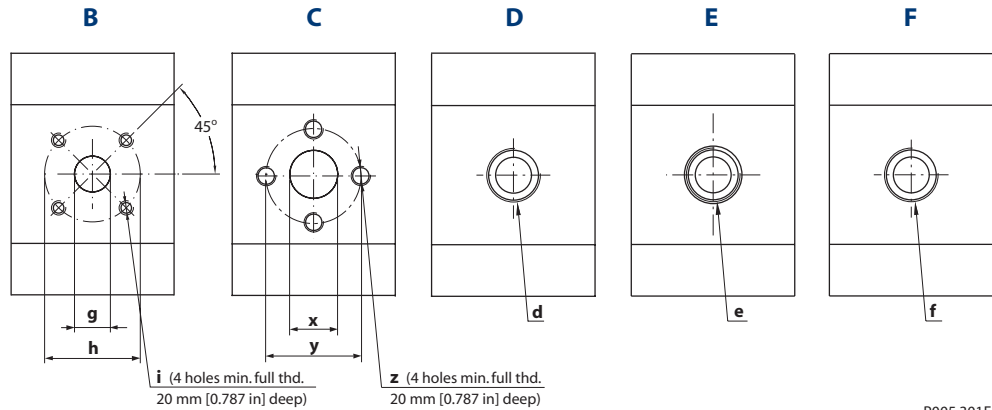

P005 301E

Bidirectional motor ports

SKM1NN bidirectional motor ports dimensions (all frame sizes)

Port type	B			C			D	E	F
Port dimensions	g	h	i	x	y	z	d	e	f
Inlet/Outlet	13 [0.512]	30 [1.181]	M6	12 [0.472]	26 [1.024]	M5	M18x1.5	¾-16UNF-2B	¾ Gas (BSPP)
Drain	M12x1.5			M12x1.5			M12x1.5	7/16-20UNF-2B	1/8 Gas (BSPP)

Unidirectional motor ports

SNU1NN, SKU1NN unidirectional motor ports dimensions

Port type	B			C			D	E	F		
Port dimensions	g	h	i	x	y	z	d	e	f		
Frame size	2,6	Inlet	8 [0.315]	30 [1.181]	M6	12 [0.472]	26 [1.024]	M5	M14x1.5	9/16-18UNF-2B	¾ Gas (BSPP)
		Outlet	13 [0.512]						M18x1.5	¾-16UNF-2B	
	3,2	Inlet	8 [0.315]						M14x1.5	9/16-18UNF-2B	
		Outlet	13 [0.512]						M18x1.5	¾-16UNF-2B	
	3,8	Inlet	8 [0.315]						M14x1.5	9/16-18UNF-2B	
		Outlet	13 [0.512]						M18x1.5	¾-16UNF-2B	
	4,3	Inlet	8 [0.315]						M14x1.5	9/16-18UNF-2B	
		Outlet	13 [0.512]						M18x1.5	¾-16UNF-2B	
	6,0	Inlet	13 [0.512]						M18x1.5	9/16-18UNF-2B	
		Outlet	13 [0.512]						M18x1.5	¾-16UNF-2B	
	7,8	Inlet	13 [0.512]						M18x1.5	9/16-18UNF-2B	
		Outlet	13 [0.512]						M18x1.5	¾-16UNF-2B	
	010	Inlet	13 [0.512]						M18x1.5	9/16-18UNF-2B	
		Outlet	13 [0.512]						M18x1.5	¾-16UNF-2B	
	012	Inlet	13 [0.512]						M18x1.5	9/16-18UNF-2B	
		Outlet	13 [0.512]						M18x1.5	¾-16UNF-2B	

SKM1NN, SKU1NN,
SNU1NN – 01BA

Standard porting drawing for 01BA

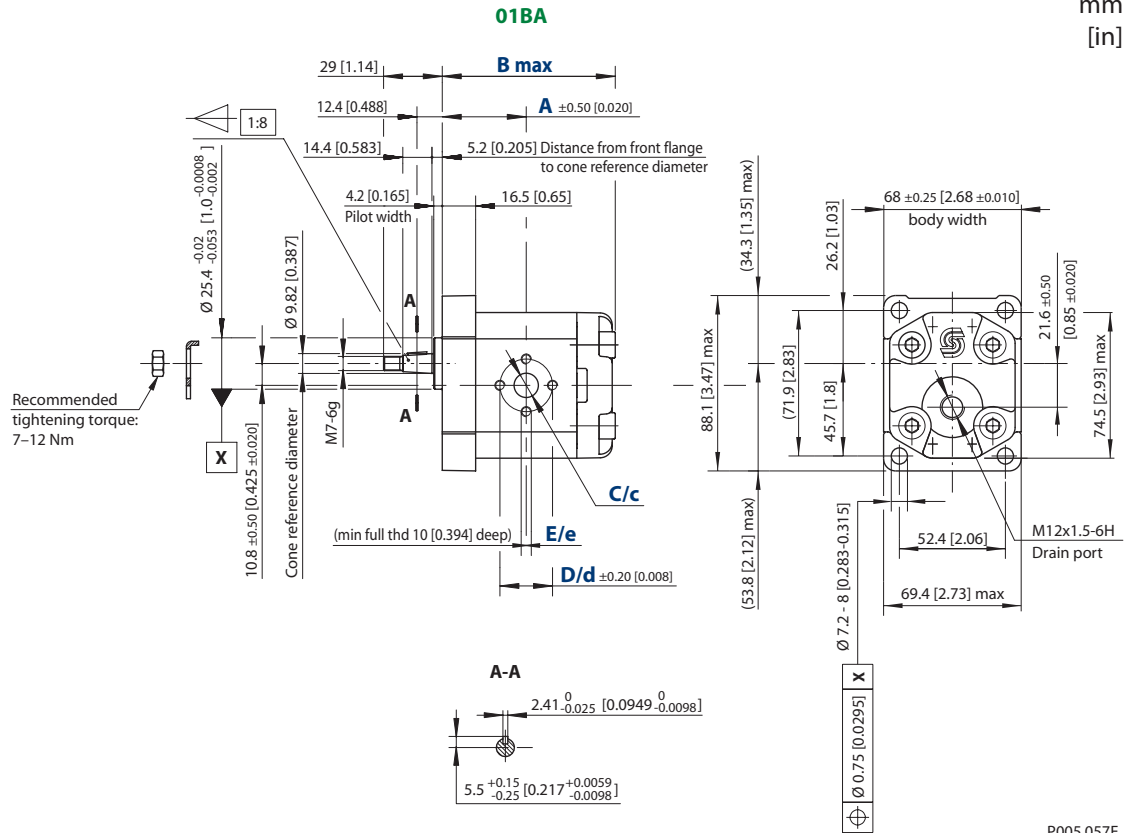

P005 057E

For unidirectional motors no case drain hole into the rear cover.

SKM1NN – 01BA dimensions

Type (displacement)	2,6	3,2	3,8	4,3	6,0	7,8	010	012	
Dimension	A	40.5 [1.594]	41.5 [1.634]	42.5 [1.673]	43.5 [1.713]	46.75 [1.841]	50.0 [1.969]	54.5 [2.146]	58.5 [2.303]
	B	85.0 [3.346]	87.0 [3.425]	89.0 [3.504]	91.0 [3.583]	97.5 [3.839]	104.0 [4.094]	113.0 [4.449]	121.0 [4.764]
Inlet/Outlet	C/c	12 [0.472]							
	D/d	26 [1.024]							
	E/e	M5							

For unidirectional SNU1NN, SKU1NN dimensions, see *Ports dimensions*, page 22.

Model code examples and maximum shaft torque

Flange/drive gear	Model code example	Maximum shaft torque
01BA	SKM1NN/3,2BN01BAM1C2C2NNNN/NNNNN SKU1NN/4,3LN01BAP1C2C2NNNN/NNNNN SNU1NN/3,8RN01BAP1F3F3NNNN/NNNNN	25 N·m [221 lb·in]

For further details on ordering, see *Model Code*, pages 15 and 16.

**SKM1NN, SKU1NN –
02BB, 02FA**

Standard porting drawing for 02BB and 02FA

mm
[in]

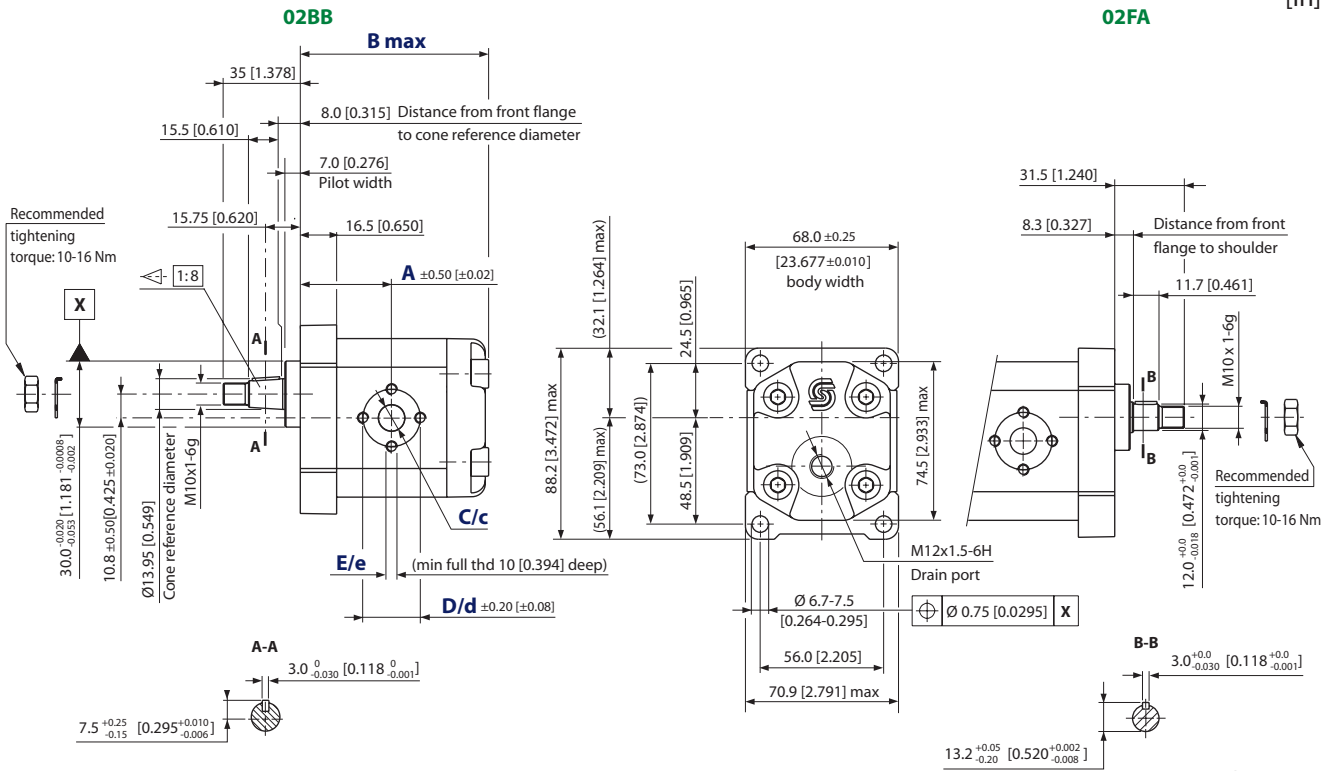

P005 058E

For unidirectional motors no case drain hole into the rear cover.

SKM1NN – 02BB and 02FA dimensions

Type (displacement)	2,6	3,2	3,8	4,3	6,0	7,8	010	012	
Dimension	A	40.5 [1.594]	41.5 [1.634]	42.5 [1.673]	43.5 [1.713]	46.75 [1.841]	50.0 [1.969]	54.5 [2.146]	58.5 [2.303]
	B	85.0 [3.346]	87.0 [3.425]	89.0 [3.504]	91.0 [3.583]	97.5 [3.839]	104.0 [4.094]	113.0 [4.449]	121.0 [4.764]
Inlet/Outlet	C/c	12 [0.472]							
	D/d	26 [1.024]							
	E/e	M5							

For unidirectional SKU1NN dimensions, see *Ports dimensions*, page 22.

Model code examples and maximum shaft torque

Flange/drive gear	Model code example	Maximum shaft torque
02BB	SKM1NN/010BN02BBM1C2C2NNNN/NNNNN SKU1NN/6,0LN02BBM1C2C2NNNN/NNNNN	50 N·m [442 lb·in]
02FA	SKM1NN/6,0BN02FAM1C2C2NNNN/NNNNN SKU1NN/6,0LN02FAM1C2C2NNNN/NNNNN	24 N·m [212 lb·in]

For further details on ordering, see *Model Code*, pages 15 and 16.

**SKM1NN, SKU1NN –
06GA and 06SA**

Standard porting drawing for 06GA and 06SA

mm
[in]

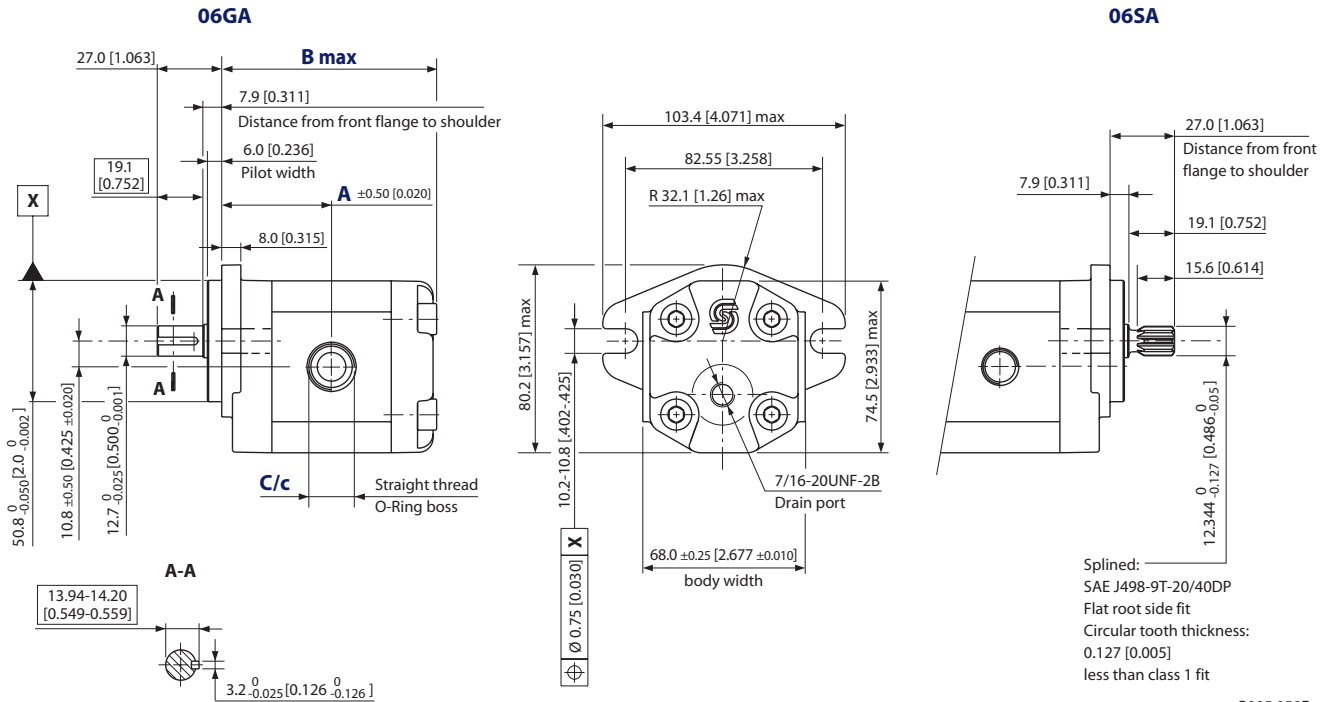

P005 059E

For unidirectional motors no case drain hole into the rear cover.

SKM1NN – 06GA and 06SA dimensions

Type (displacement)	2,6	3,2	3,8	4,3	6,0	7,8	010	012	
Dimension	A	45 [1.771]	46 [1.811]	47 [1.850]	48 [1.889]	51.25 [2.017]	54.5 [2.145]	59 [2.322]	63.5 [2.500]
	B	89.5 [3.523]	91.5 [3.602]	93.5 [3.681]	95.5 [3.759]	102 [4.015]	108.5 [4.271]	117.5 [4.625]	125.5 [4.940]
Inlet/Outlet	C/c $\frac{3}{4}$ -16UNF-2B, THD 14.3 [0.563] deep								

For unidirectional SKU1NN dimensions, see *Ports dimensions*, page 22.

Model code examples and maximum shaft torque

Flange/drive gear	Model code example	Maximum shaft torque
06GA	SKM1NN/6,0BN06GAM6E4ENNNN/NNNNN SKU1NN/4,3RN06GAP1E3E4NNNN/NNNNN	32 N•m [283 lb•in]
06SA	SKM1NN/012BN06SAM6E4ENNNN/NNNNN SKU1NN/3,2LN06SAP1E3E4NNNN/NNNNN	34 N•m [301 lb•in]

For further details on ordering, see *Model Code*, pages 15 and 16.

Gear Motors • Group 2 Technical Information General Information

Motor design

SNM2NN

SNM2NN is the group 2 bidirectional motor available in the whole displacements range from 6 up to 25 cm³/rev [from 0.37 up to 1.538 in³/rev]. Configurations include European and SAE flanges and shafts (Code 01BA, 01FA, 01DA, 02AA, 02DB, 03CA, 04AA/05AA, 04DB/05DB, 06GA, 06SA).

SNU2NN

SNU2NN is the group 2 unidirectional motor available in the displacements range from 8 up to 25 cm³/rev [from 0.513 up to 1.538 in³/rev]. The SNU2NN motor construction is derived from the correspondent pump SNP2NN. Configurations include European and SAE flanges and shafts (Code 01BA, 01FA, 01DA, 02AA, 02DB, 03CA, 04AA/05AA, 04DB/05DB, 06GA, 06SA).

SKU2NN

SKU2NN is the Group 2 unidirectional motor available in the displacements range from 8 up to 25 cm³/rev [from 0.513 up to 1.538 in³/rev]. The SKU2NN motor construction is derived from the correspondent pump SKP2NN. Configuration includes SAE flange and shaft only (Code 06SA).

SNM2NN 9JDB (cut-away)

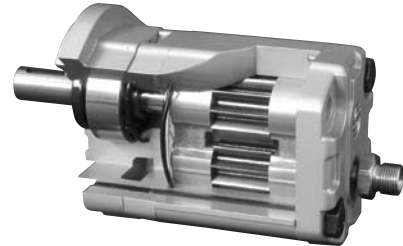

F005 214

SNU2NN 06SA (cut away)

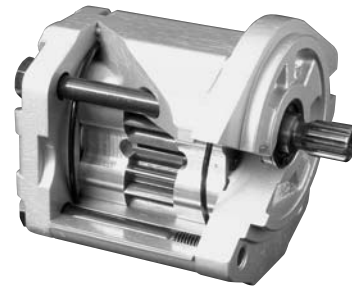

F005 030

Technical data

The table below details the technical data for Group 2 gear motors based on the model and displacement configuration.

Technical data for Group 2 gear motors

		Frame size							
		6,0*	8,0	011	014	017	019	022	025
Displacement	cm ³ /rev [in ³ /rev]	6.0 [0.36]	8.4 [0.513]	10.8 [0.659]	14.4 [0.879]	16.8 [1.025]	19.2 [1.171]	22.8 [1.391]	25.2 [1.538]
SNM2NN (bidirectional motor)									
Peak pressure	bar [psi]	280 [4060]	280 [4060]	280 [4060]	280 [4060]	260 [3770]	230 [3335]	200 [2900]	180 [2610]
Rated pressure		250 [3625]	250 [3625]	250 [3625]	250 [3625]	230 [3335]	210 [3045]	180 [2610]	160 [2320]
Outlet back pressure		250 [3625]	250 [3625]	250 [3625]	250 [3625]	230 [3335]	210 [3045]	180 [2610]	160 [2320]
Minimum speed	min ⁻¹ (rpm)	700	700	700	700	500	500	500	500
Maximum speed		4000	4000	4000	4000	4000	3500	3500	3500
SNU2NN (unidirectional motor)									
Peak pressure	bar [psi]	-	280 [4060]	280 [4060]	280 [4060]	260 [3770]	230 [3335]	200 [2900]	180 [2610]
Rated pressure			250 [3625]	250 [3625]	250 [3625]	230 [3335]	210 [3045]	180 [2610]	160 [2320]
Minimum speed	min ⁻¹ (rpm)		600	600	600	500	500	500	500
Maximum speed			3500	3500	3500	3000	3000	3000	2500
SKU2NN (unidirectional motor)									
Peak pressure	bar [psi]	-	280 [4060]	280 [4060]	280 [4060]	260 [3770]	230 [3335]	200 [2900]	175 [2815]
Rated pressure			250 [3625]	250 [3625]	250 [3625]	230 [3335]	210 [3045]	180 [2610]	160 [2320]
Minimum speed	min ⁻¹ (rpm)		600	600	600	500	500	500	500
Maximum speed			3500	3500	3500	3000	3000	3000	2500
All (SNM2NN, SNU2NN, SKU2NN)									
Weight	kg [lb]	2.4 [5.3]	2.5 [5.5]	2.7 [5.5]	2.9 [6.3]	3.0 [6.5]	3.1 [6.7]	3.2 [7.0]	3.3 [7.3]
Moment of inertia of rotating components	x 10 ⁻⁶ kg·m ² [x 10 ⁻⁶ lb·ft ²]	26.5 [629]	32.4 [769]	38.4 [911]	47.3 [1122]	53.3 [1265]	59.2 [1405]	68.1 [1616]	74.1 [1758]
Theoretical flow at maximum speed	l/min [US gal/min]	24 [6.3]	33.6 [8.9]	43.2 [11.4]	50.4 [13.3]	50.4 [13.3]	57.6 [15.2]	68.4 [18.0]	75.6 [20.0]

1 kg·m² = 23.68 lb·ft²

* Before choosing this frame size, please apply to Turolla OCG technical department.

⚠ Caution

The rated and peak pressure mentioned are for motors with flanged ports only. When threaded ports are required a de-rated performance has to be considered. To verify the compliance of an high pressure application with a threaded ports pump apply to a Turolla OCG representative.

Model code

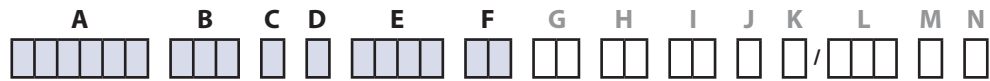

A Type

SNM2NN	Bidirectional gear motor
SHM2NN	High pressure bidirectional gear motor
SNU2NN	Unidirectional gear motor
SNM2IN	Unidirectional gear motor with integrated relief valve (internal drain)
SNM2GN	Unidirectional gear motor with anti-cavitation check valve
SNM2JN	Unidirectional gear motor with integrated relief valve and anti-cavitation check valve

B Displacement

6,0	6.0 cm ³ /rev [0.360 in ³ /rev]
8,0	8.4 cm ³ /rev [0.513 in ³ /rev]
011	10.8 cm ³ /rev [0.659 in ³ /rev]
014	14.4 cm ³ /rev [0.879 in ³ /rev]
017	16.8 cm ³ /rev [1.025 in ³ /rev]
019	19.2 cm ³ /rev [1.171 in ³ /rev]
022	22.8 cm ³ /rev [1.391 in ³ /rev]
025	25.2 cm ³ /rev [1.538 in ³ /rev]

C Direction of rotation

R	Right hand (clockwise)
L	Left hand (counterclockwise)
B	Bidirectional

D Version

N	Standard version
----------	------------------

E Mounting flange and shaft

Code	Description	SNM2NN	SHM2NN	SNU2NN	SNM2IN	SNM2GN	SNM2JN
01BA	European 4-bolt flange 01 • Tapered shaft 1:8	●	-	●	-	●	●
01FA	European 4-bolt flange 01 • Parallel shaft 15mm [0.591 in]	●	-	●	-	-	-
01DA	European 4-bolt flange 01 • DIN splined shaft	●	-	●	-	-	-
02AA	European 4-bolt flange 02 • Tapered shaft 1:5	●	-	●	-	●	-
02DB	European 4-bolt flange 02 • DIN splined shaft	●	-	●	●	-	-
03CA	Turolia OCG tang shaft • Flange for multiple configuration	●	-	●	●	●	-
04AA	German engine PTO 2-bolt • Tapered shaft 1:5	●	-	●	-	-	-
05AA	German engine PTO 2-bolt • Tapered shaft 1:5	●	-	●	-	-	-
05DB	German engine PTO 2-bolt • DIN splined shaft	-	-	●	-	-	-
06GA	SAE A flange • Parallel shaft 15.875 mm [0.625 in]	●	●	●	-	●	-
06SA	SAE A flange • SAE splined shaft	●	-	●	-	-	-

Legend:

- = Standard
- = Optional
- = Not Available

F Rear cover

P1	Standard cover for unidirectional gear motor
L1	Cover for motor-side drain in vertical axis ¼ Gas
L6	Cover for motor-side drain in vertical axis ¼-18UNF-2B
M1	Standard cover for motor drain ¼ GAS driven side
M3	Cover for motor drain ¼ GAS + holes M5 (03 flange only)
M6	Standard cover for motor drain ¼-18UNF-2B

Model code
(continued)



G Inlet port*

H Outlet port*

B5	15 x 35 x M6	Flanged port, 4-threaded holes in X pattern, in the center or off-set of the body
B6	15 x 40 x M6	
B7	20 x 40 x M6	
BB	27 x 55 x M8	
C2	12 x 26 x M5	Flanged port, 4-threaded holes in + pattern, (European standard ports)
C3	13.5 x 30 x M6	
C5	13.5 x 40 x M8	
C7	20 x 40 x M8	
C8	23.5 x 40 x M8	
D4	M16 x 1.5	Threaded metric port
D5	M18 x 1.5	
D7	M22 x 1.5	
D9	M26 x 1.5	
E3	$\frac{1}{16}$ -18UNF	Threaded SAE O-ring boss port
E4	$\frac{3}{4}$ -16UNF	
E5	$\frac{7}{8}$ -14UNF	
E6	1- $\frac{1}{16}$ -12UN	
E8	1- $\frac{5}{16}$ -12UN	
F3	$\frac{3}{8}$ GAS	Threaded GAS (BSPP) port
F4	$\frac{1}{2}$ GAS	
F5	$\frac{3}{4}$ GAS	
F6	1 GAS	
H5	M18 x 1.5	Threaded metric port ISO6149
H7	M22 x 1.5	
H8	M27 x 2	
H9	M33 x 2	

* For more information see [Port dimensions](#), page 36.

I Port position and variant body

NN	Std from catalogue
YY	Port Bx-Bx for flange SAE off-set from center of body as per catalogue
ZZ	Port type Bx-Bx in center of the body

**Model code
(continued)**



J Sealing

N	Standard Buna seal
B	VITON seals
D	Buna seals+VITON shaft seal with dust lip

K Screws

N	Standard screws
A	Galvanized screws+nuts-washers
B	DACROMET/GEOMET screws

L Set valve

NNN	No valve
V**	Integral RV-Pressure setting. Motor speed for relief valve setting (min^{-1} [rpm])

M Marking

N	Standard marking
A	Standard marking + Customer Code
Z	Without marking

N Mark position

N	Standard marking position
A	Mark on the bottom ref. to drive gear

Motor performance graphs

The graphs on the next few pages provide typical output flow and input power for Group 2 motors at various working pressures. Data were taken using ISO VG46 petroleum / mineral based fluid at 50 °C [122 °F] (viscosity = 28 mm²/s [132 SUS]).

SNM2NN/6,0 motor performance graph

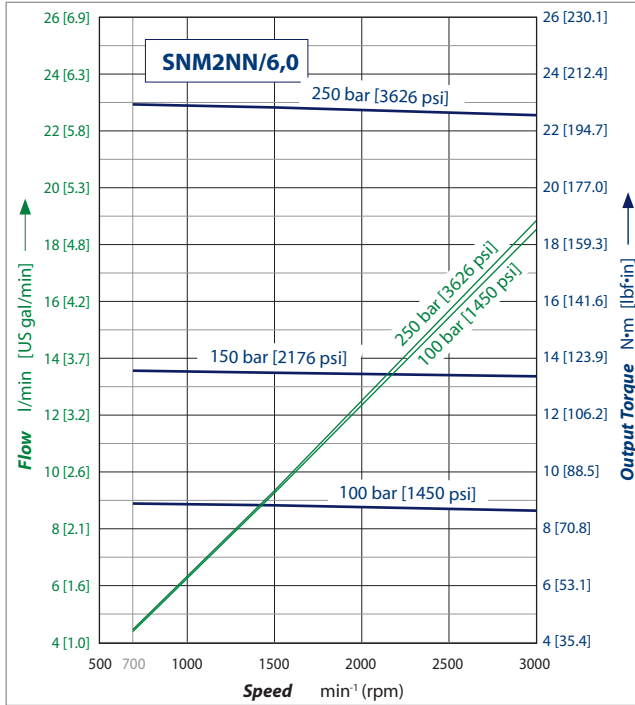

SNM2NN/8,0 motor performance graph

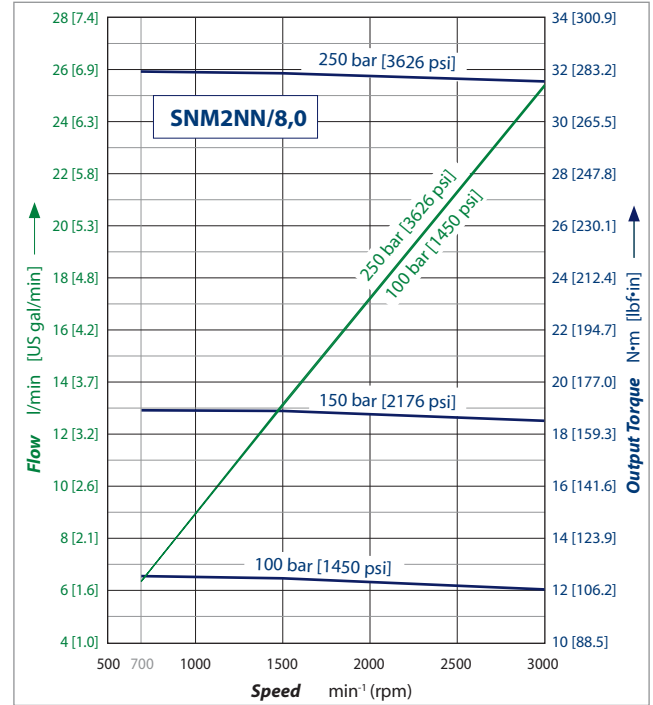

SNM2NN/011 motor performance graph

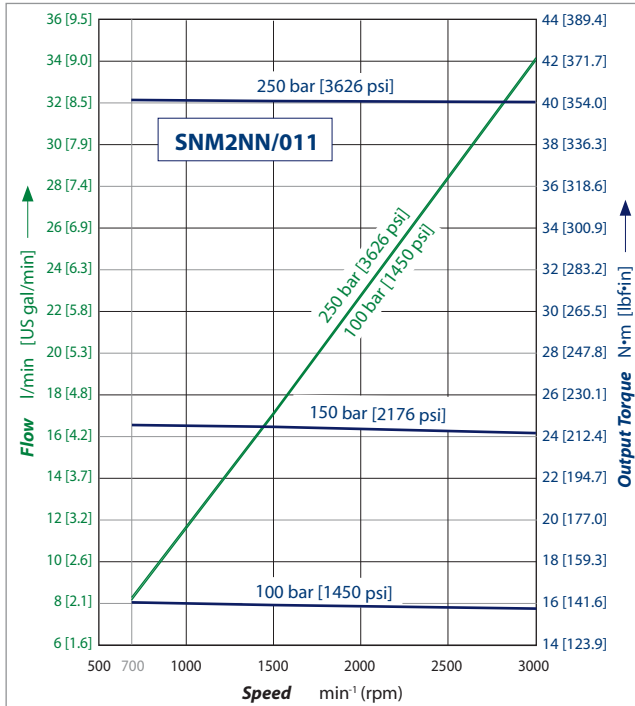

SNM2NN/014 motor performance graph

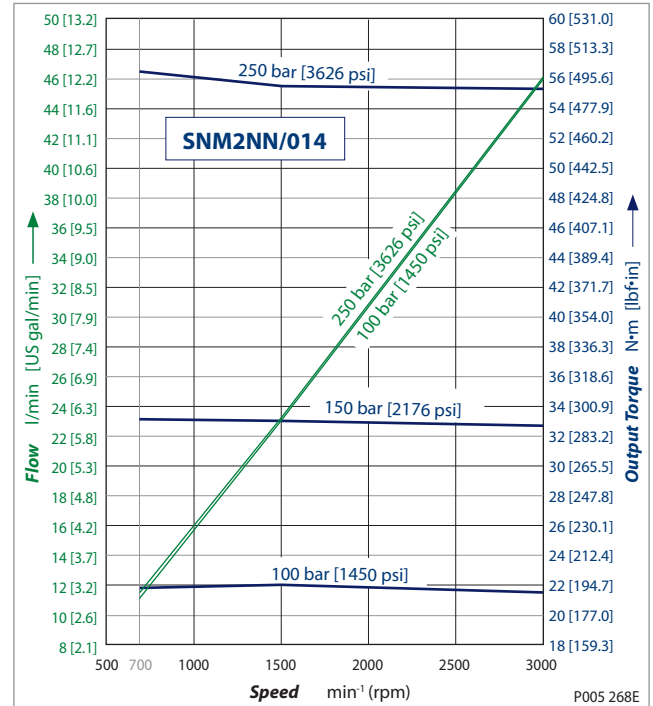

Motor performance graphs (continued)

SNM2NN/017 motor performance graph

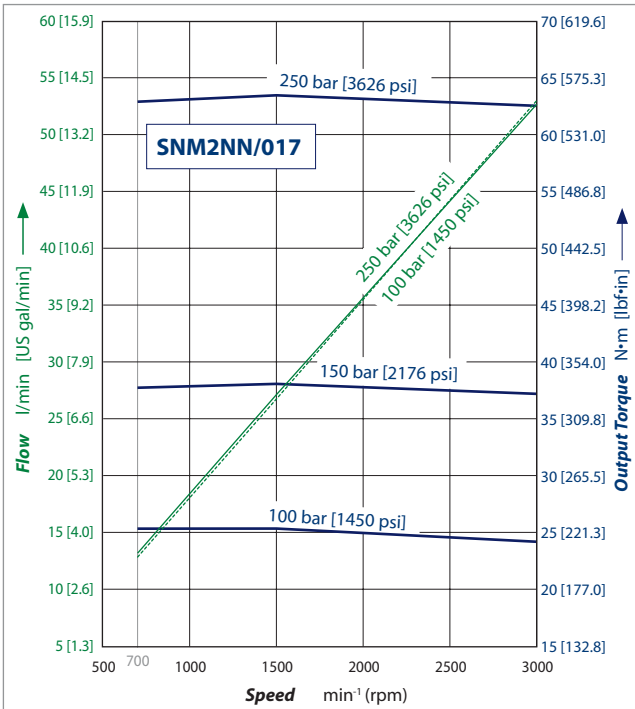

SNM2NN/019 motor performance graph

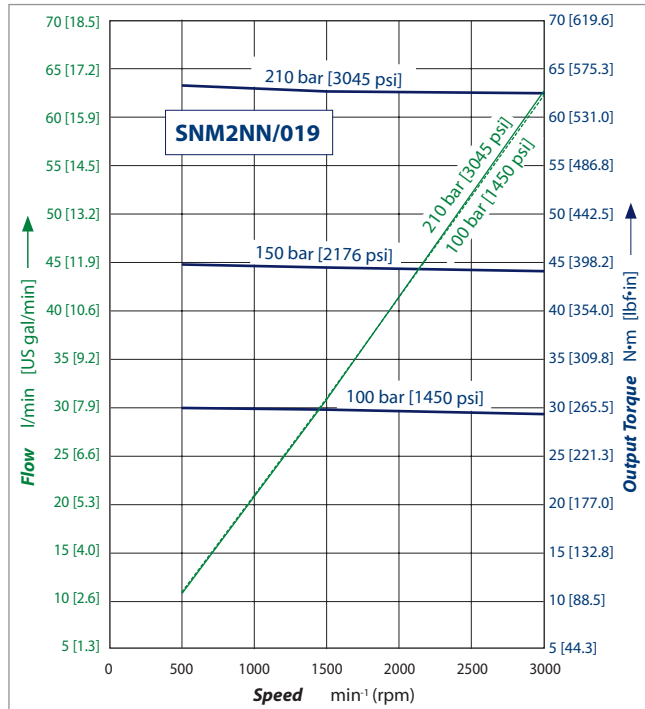

SNM2NN/022 motor performance graph

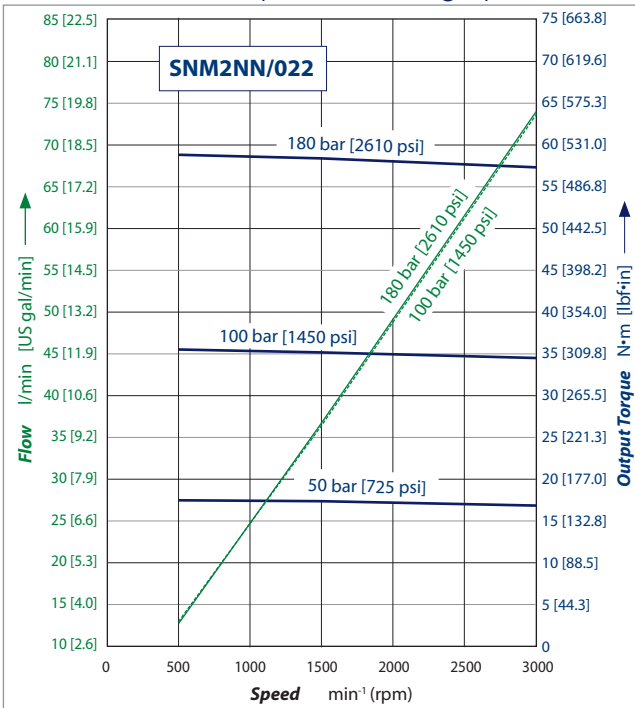



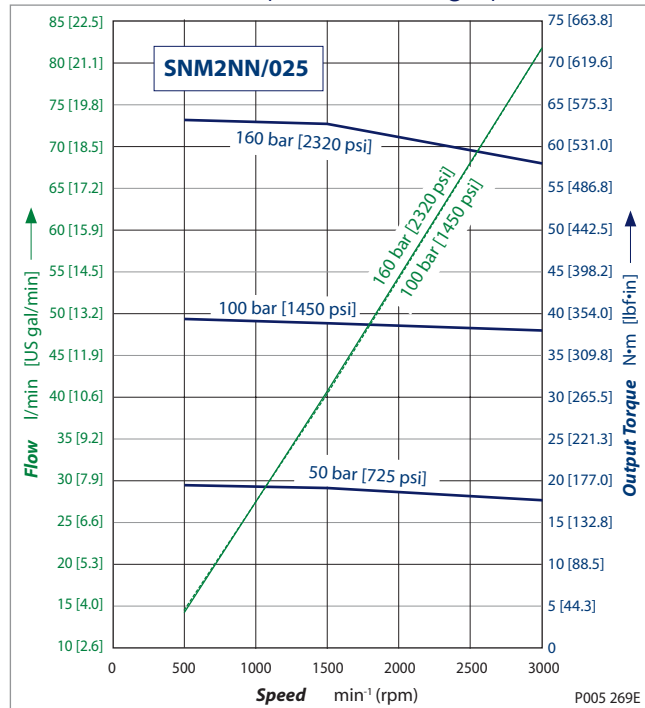



SNM2NN/025 motor performance graph

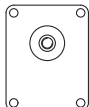
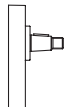
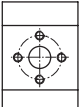

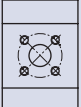
Flange, shaft and port configurations

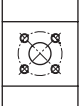
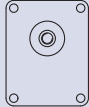
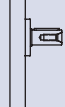
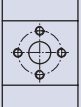
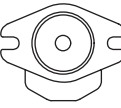
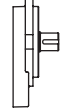
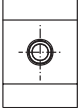
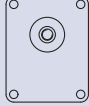
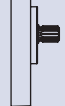
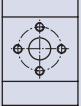
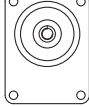
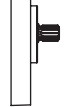
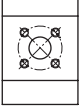
Flange, shaft and port configurations for SNM2NN and SNU2NN motors

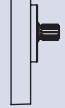
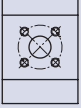
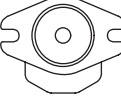
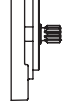
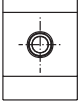
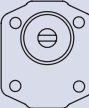
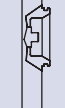
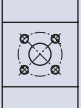
Code	Flange	Shaft	Port
01BA	European 01, 4-bolts pilot Ø 36.5 mm [1.44 in] 	1:8 tapered 	European in + pattern 
02AA	European 02, 4-bolts pilot Ø 80 mm [3.15 in] 	1:5 tapered 	German standard in X pattern 
04AA/ 05AA	German PTO 2-bolts pilot Ø 50 mm [1.97 in] 	1:5 tapered 	German standard in X pattern 
01FA	European 01, 4-bolts pilot Ø 36.5 mm [1.44 in] 	Ø 15 mm [0.59 in] parallel 	European in + pattern 
06GA	SAE A pilot Ø 82.55 mm [3.25 in] 	Ø 15.7 mm [0.625 in] parallel 	Threaded SAE O-ring boss port 
01DA	European 01, 4-bolts pilot Ø 36.5 mm [1.44 in] 	9-teeth splined $m = 1.60, \alpha = 30^\circ$ DIN 5482-B17x14 	European in + pattern 
02DB	European 02, 4-bolts pilot Ø 80 mm [3.15 in] 	9-teeth splined $m = 1.60, \alpha = 30^\circ$ DIN 5482-B17x14 	German standard in X pattern 
04DB/ 05DB	German PTO 2-bolts pilot Ø 50 mm [1.97 in] 	9-teeth splined $m = 1.60, \alpha = 30^\circ$ DIN 5482-B17x14 	German standard in X pattern 
06SA	SAE A pilot Ø 82.55 mm [3.25 in] 	SAE 9-teeth splined 	Threaded SAE O-ring boss port 
03CA	Turolia OCG tang pilot Ø 52 mm [2.066 in] 	Turolia OCG standard tang 	German standard in X pattern 

Mounting flanges options

Turolia OCG offers many types of industry standard mounting flanges. *The table below shows order codes for each available mounting flange and its intended use*

Flange availability

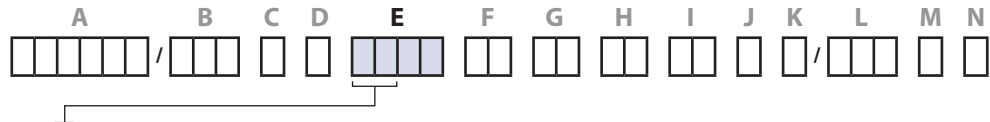

Option	Description
01	European 25.4 mm [1 in] 4-bolt
02	European 30 mm [1.18 in] 4-bolt
06	SAE A-A

Shaft options

Group 2 motors are available with a variety of splined, parallel, and tapered shaft ends. Not all shaft styles are available with all flange styles.

Valid combinations and nominal torque ratings are shown in the table below. Torque ratings assume no external radial loading. Applied torque must not exceed these limits regardless of pressure parameters stated earlier. Maximum torque ratings are based on shaft torsional fatigue strength.

Shaft availability and nominal torque capability

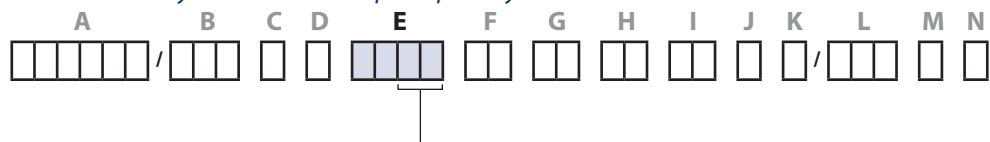

Shaft		Mounting flange code with maximum torque in N·m [lb·in]							
Code	Description	01	02	03	04	05	06	09	0B
AA	Taper 1:5	-	140 [1239]	-	140 [1239]	140 [1239]	-	-	-
BA	Taper 1:8	150 [1328]	-	-	-	-	-	150 [1328]	150 [1328]
DA	DIN spline B17x14	90 [797]	-	-	-	-	-	-	-
DB	DIN spline B17x14	-	130 [1151]	-	130 [1151]	130 [1151]	-	-	-
SA	SAE spline 9T 16/32p	-	-	-	-	-	75 [646]	-	-
SB	SAE spline 11T 16/32p	-	-	-	-	-	150 [1328]	-	-
FA	Parallel 15 mm [0.590 in]	90 [797]	-	-	-	-	-	-	-
GA	Parallel 15.875 mm [0.625 in]	-	-	-	-	-	80 [708]	-	-
CA	Turolia OCG Tang	-	-	70 [620]	-	-	-	-	-

Recommended mating splines for Group 2 splined output shafts should be in accordance with SAE J498 or DIN 5482. Turolia OCG external SAE splines are flat root side fit with circular tooth thickness reduced by 0.127 mm [0.005 in] in respect to class 1 fit. The external DIN splines have an offset increased by 0.1 mm [0.004 in.] These dimensions are modified in order to assure a clearance fit with the mating spline.

Other shaft options may exist. Contact your Sauer- Danfoss representative for availability.

⚠ Caution

Shaft torque capability may limit allowable pressure. Torque ratings assume no external radial loading. Applied torque must not exceed these limits, regardless of stated pressure parameters. Maximum torque ratings are based on shaft torsional fatigue strength.

Port configurations

Various port configurations are available on Group 2 motors. They include:

- European standard flanged ports
- German standard flanged ports
- Gas threaded ports (BSPP)
- O-ring boss (following SAE J1926/1 [ISO 11926-1] UNF threads, standard)

Available port configurations for **Inlet (G)** and **Outlet (H)**



Port		
Code	Dimension	Description
B5	15 x 35 x M6	Flanged port, 4-threaded holes in X pattern, in the center or off-set of the body
B6	15 x 40 x M6	
B7	20 x 40 x M6	
BB	27 x 55 x M8	
C2	12 x 26 x M5	Flanged port, 4-threaded holes in + pattern, (European standard ports)
C3	13.5 x 30 x M6	
C5	13.5 x 40 x M8	
C7	20 x 40 x M8	
C8	23.5 x 40 x M8	
D4	M16 x 1.5	Threaded metric port
D5	M18 x 1.5	
D7	M22 x 1.5	
D9	M26 x 1.5	
E3	$\frac{3}{16}$ -18UNF	Threaded SAE , O-ring boss port
E4	$\frac{3}{4}$ -16UNF	
E5	$\frac{7}{8}$ -14UNF	
E6	1- $\frac{1}{16}$ -12UN	
E8	1- $\frac{5}{16}$ -12UN	
F3	$\frac{3}{8}$ GAS	Threaded GAS (BSPP) port
F4	$\frac{1}{2}$ GAS	
F5	$\frac{3}{4}$ GAS	
F6	1 GAS	
H5	M18 x 1.5	Threaded metric port ISO6149
H7	M22 x 1.5	
H8	M27 x 2	
H9	M33 x 2	

Port dimensions

Available ports for Group 2 motors

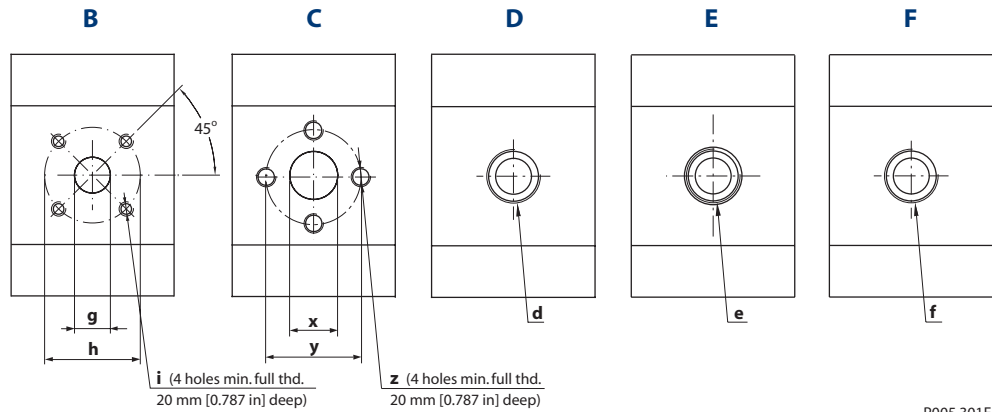

P005 301E

Bidirectional motor ports dimensions

SNM2NN bidirectional motors and SNM2GN, SNM2JN, SNM2IN motors made unidirectional only by the valve

Port type		B			C			D	E	F
Port dimensions		g	h	i	x	y	z	d	e	f
Frame size	6,0 Inlet/Outlet	15 [0.59]	35 [1.38]	M6	13.5 [0.53]	30 [1.18]	M6	M22x1.5	7/8-14UNF-2B	1/2 Gas (BSPP)
	8,0 Inlet/Outlet	15 [0.59]	35 [1.38]	M6	13.5 [0.53]	30 [1.18]	M6	M22x1.5	7/8-14UNF-2B	1/2 Gas (BSPP)
	011 Inlet/Outlet	15 [0.59]	35 [1.38]	M6	13.5 [0.53]	30 [1.18]	M6	M22x1.5	7/8-14UNF-2B	1/2 Gas (BSPP)
	014 Inlet/Outlet	15 [0.59]	35 [1.38]	M6	20 [0.79]	40 [1.58]	M8	M22x1.5	7/8-14UNF-2B	1/2 Gas (BSPP)
	017 Inlet/Outlet	15 [0.59]	35 [1.38]	M6	20 [0.79]	40 [1.58]	M8	M22x1.5	7/8-14UNF-2B	1/2 Gas (BSPP)
	019 Inlet/Outlet	20 [0.79]	40 [1.58]	M6	20 [0.79]	40 [1.58]	M8	M26x1.5	1-1/16-12UNF-2B	3/4 Gas (BSPP)
	022 Inlet/Outlet	20 [0.79]	40 [1.58]	M6	20 [0.79]	40 [1.58]	M8	M26x1.5	1-1/16-12UNF-2B	3/4 Gas (BSPP)
025 Inlet/Outlet	20 [0.79]	40 [1.58]	M6	23.5 [0.92]	40 [1.58]	M8	M26x1.5	1-1/16-12UNF-2B	3/4 Gas (BSPP)	
Drain		1/4 Gas (BSPP)						9/16-18UNF-2B		1/4 Gas (BSPP)

Unidirectional motor ports dimensions

SNU2NN and SKU2NN ports dimensions

Port type		B			C			D	E	F	
Port dimensions		g	h	i	x	y	z	d	e	f	
Frame size	8,0	Inlet	15 [0.59]	35 [1.38]	M6	13.5 [0.53]	30 [1.18]	M6	M18x1.5	1-1/16-12UNF-2B	1/2 Gas (BSPP)
		Outlet	20 [0.79]	40 [1.58]	M6	13.5 [0.53]	30 [1.18]	M6	M16x1.5	7/8-14UNF-2B	1/2 Gas (BSPP)
	011	Inlet	15 [0.59]	35 [1.38]	M6	13.5 [0.53]	30 [1.18]	M6	M18x1.5	1-1/16-12UNF-2B	3/4 Gas (BSPP)
		Outlet	20 [0.79]	40 [1.58]	M6	13.5 [0.53]	30 [1.18]	M6	M16x1.5	7/8-14UNF-2B	1/2 Gas (BSPP)
	014	Inlet	15 [0.59]	35 [1.38]	M6	13.5 [0.53]	30 [1.18]	M6	M18x1.5	1-1/16-12UNF-2B	3/4 Gas (BSPP)
		Outlet	20 [0.79]	40 [1.58]	M6	20 [0.79]	40 [1.58]	M8	M16x1.5	7/8-14UNF-2B	1/2 Gas (BSPP)
	017	Inlet	15 [0.59]	35 [1.38]	M6	13.5 [0.53]	30 [1.18]	M6	M18x1.5	1-1/16-12UNF-2B	3/4 Gas (BSPP)
		Outlet	20 [0.79]	40 [1.58]	M6	20 [0.79]	40 [1.58]	M8	M18x1.5	7/8-14UNF-2B	1/2 Gas (BSPP)
	019	Inlet	15 [0.59]	35 [1.38]	M6	13.5 [0.53]	30 [1.18]	M6	M18x1.5	1-1/16-12UNF-2B	3/4 Gas (BSPP)
		Outlet	20 [0.79]	40 [1.58]	M6	20 [0.79]	40 [1.58]	M8	M18x1.5	7/8-14UNF-2B	1/2 Gas (BSPP)
	022	Inlet	15 [0.59]	35 [1.38]	M6	13.5 [0.53]	30 [1.18]	M6	M18x1.5	1-1/16-12UNF-2B	3/4 Gas (BSPP)
		Outlet	20 [0.79]	40 [1.58]	M6	20 [0.79]	40 [1.58]	M8	M18x1.5	7/8-14UNF-2B	1/2 Gas (BSPP)
	025	Inlet	15 [0.59]	35 [1.38]	M6	13.5 [0.53]	30 [1.18]	M6	M18x1.5	1-1/16-12UNF-2B	1 Gas (BSPP)
		Outlet	20 [0.79]	40 [1.58]	M6	20 [0.79]	40 [1.58]	M8	M18x1.5	7/8-14UNF-2B	3/4 Gas (BSPP)

Integral relief valve – SNM2IN

Turolia OCG offers an optional **integral relief valve** integrated in the Group 2 motors rear cover. It is drained internally and directs all the flow from the motor inlet to the outlet when the inlet pressure reaches the valve setting.

The tables below show applicable variant codes for ordering motors with integral relief valve. Refer to *Model Code*, page 30 for more information.

Valve schematic diagram

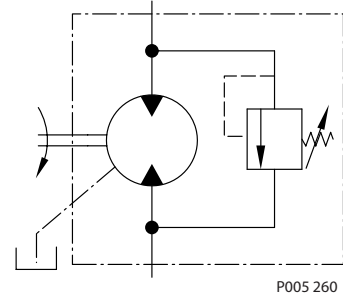

Integral relief valve rear cover cross section

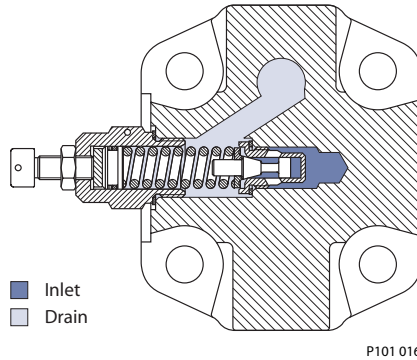

Pressure vs flow

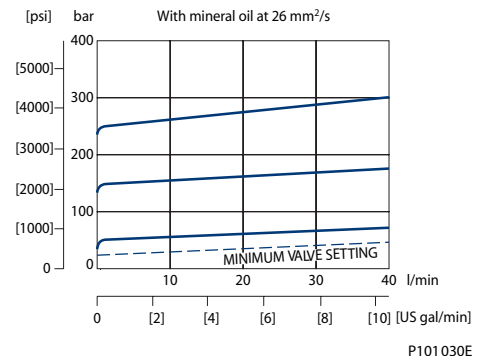

Variant codes for ordering integral relief valve



L Variant code (left part)

Code	Motor speed for RV setting min ⁻¹ (rpm)
A	not defined
C	500
E	1000
F	1250
G	1500
K	2000
I	2250
L	2500
M	2800
N	3000
O	3250

L Variant code (right part)

Code	Pressure setting bar [psi]
A	no setting
B	no valve
C	18 [261]
D	25 [363]
E	30 [435]
F	35 [508]
G	40 [580]
J	150 [2175]
K	50 [725]
L	60 [870]
M	70 [1015]
N	80 [1160]

Code	Pressure setting bar [psi]
O	90 [1305]
P	100 [1450]
Q	110 [1595]
R	120 [1740]
S	130 [1885]
T	140 [2030]
U	160 [2321]
V	170 [2466]
W	180 [2611]
X	210 [3046]
Z	250 [3626]

Anti-cavitation check valve – SNM2GN

Turolia OCG offers an optional **integral anti-cavitation check valve** integrated in Group 2 motors bearing blocks. Available for all the displacements, the valve directs internally the flow from the motor outlet to the inlet, when the outlet pressure gets higher then the inlet one.

Valve schematic diagram

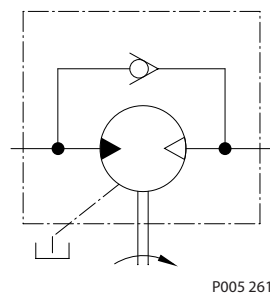

Anticavitation check valve cross section

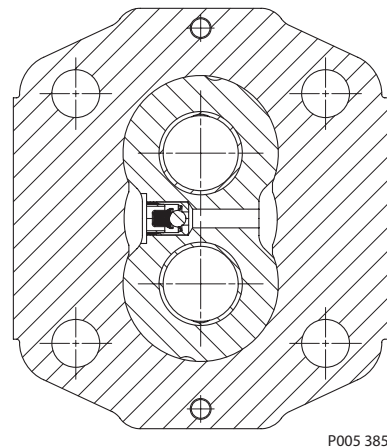

Integral relief valve and Anti-cavitation check valve – SNM2JN

Turolia OCG offers the Group 2 motors with an optional **integral relief valve** integrated in the rear cover and **anti-cavitation check valve** integrated in the bearing block. The integral relief valve is drained internally and directs all the flow from the motor inlet to the outlet when the inlet pressure reaches the valve setting. The anti-cavitation check valve directs internally the flow from the motor outlet to the inlet, when the outlet pressure gets higher then the inlet one.

Valve schematic diagram

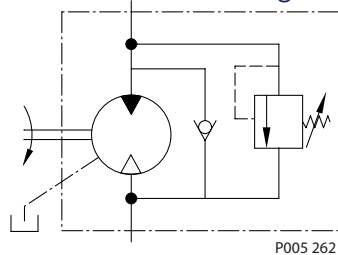

Outrigger bearing assembly – SNM2NN

An **outrigger bearing** is available for applications with high radial or thrust loads on the shaft. This option is used primarily for applications with high shaft loads. The design utilizes roller bearings in the front mounting flange. These bearings absorb the radial and thrust loads on the shaft so that the life of the motor is not affected. The use of roller bearings allows life to be described in B_{10} hours.

Available configurations



Flange/Shaft Code*	Mounting Flange	Shaft
9ADB	European 4-bolt	Taper 1:8
9FDB	German PTO	Taper 1:5
94DB	German 4-bolt	Taper 1:5
9HDB	SAE A	Taper 1:8
9JDB	SAE A	Parallel

* Codes represent assembly (complete motor with outrigger bearing).

The table above shows applicable variant codes for ordering motors with outrigger bearing. Refer to *Model Code*, pages 30 and 31 for more information.

Outrigger bearing assembly – SNM2NN (continued)

The graphs below show allowable shaft loads for 1000 hour life at 1500 min⁻¹ (rpm) versus distance from flange face to center of radial load.

Radial load vs distance from flange

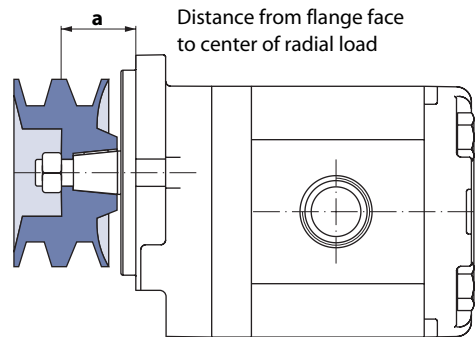
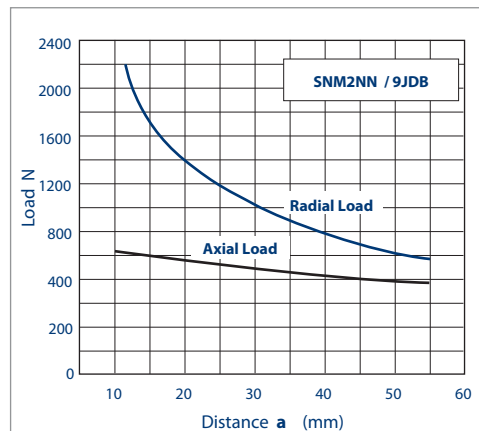
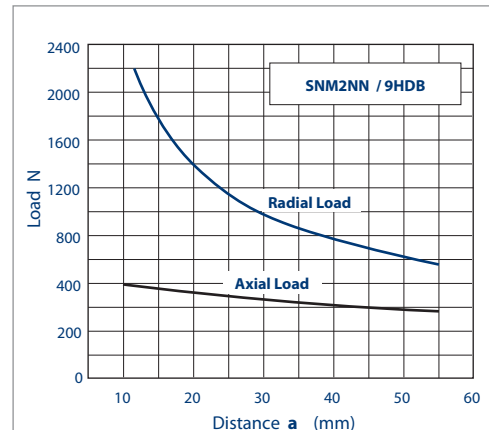
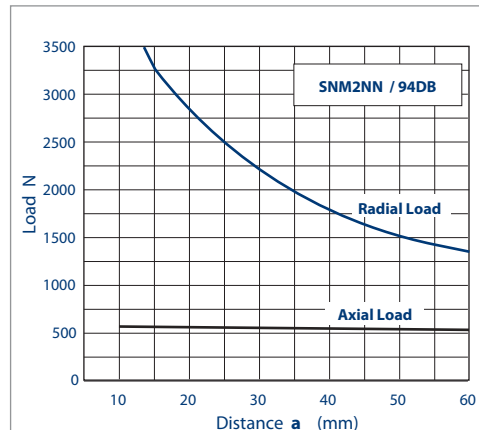
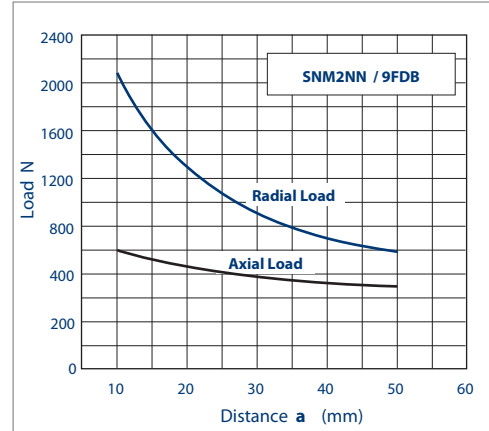
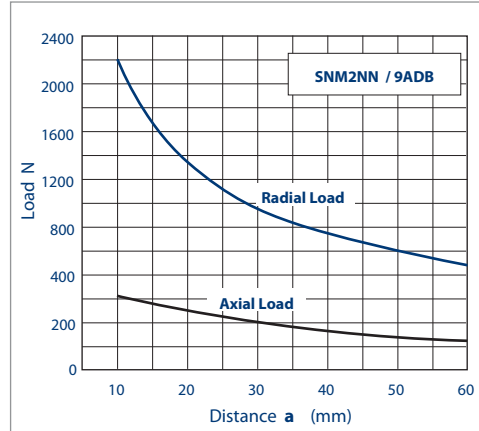

P101 036E

P005 299E

Outrigger bearing assembly – SNM2NN (continued)

Dimensions

SNM2NN/.. 9ADB
SNM2NN/.. 03DB

Outrigger bearing 9ADB

mm
[in]

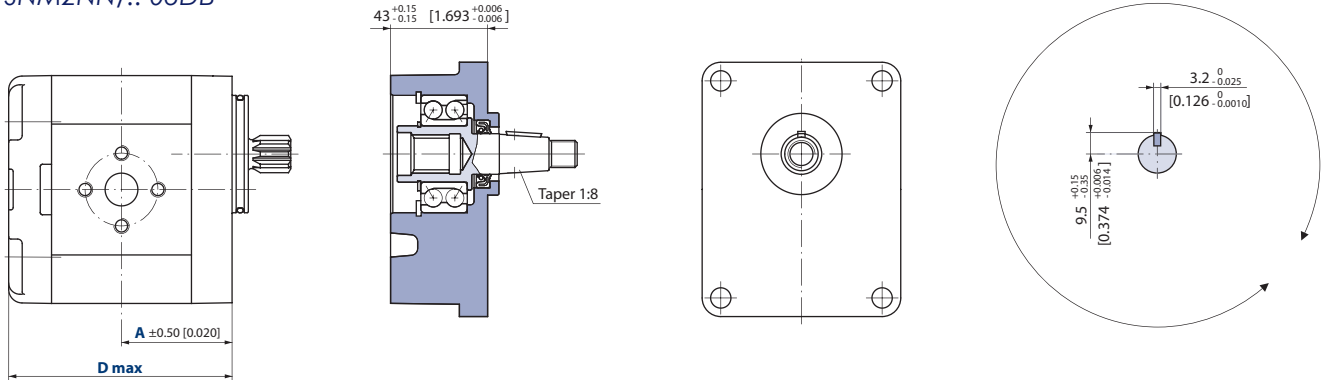

SNM2NN/.. 94DB
SNM2NN/.. 03DB

Outrigger bearing 94DB

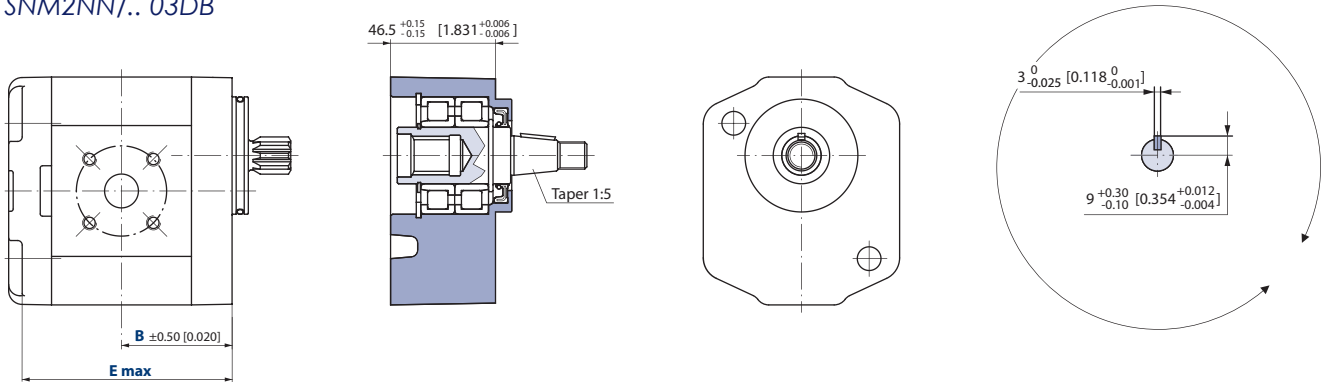

SNM2NN/.. 9JDB
SNM2NN/.. 03DB

Outrigger bearing 9JDB

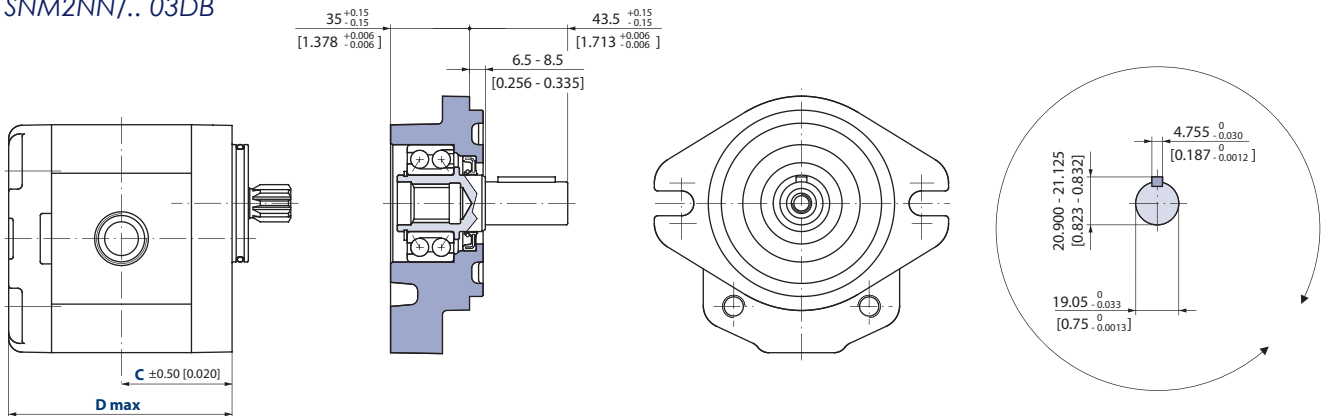

P005 276E

Outrigger bearing assembly – SNM2NN (continued)

Dimensions (continued)

SNM2NN/.. 9FDB
SNM2NN/.. 03DB

Outrigger bearing 9FDB

mm
[in]

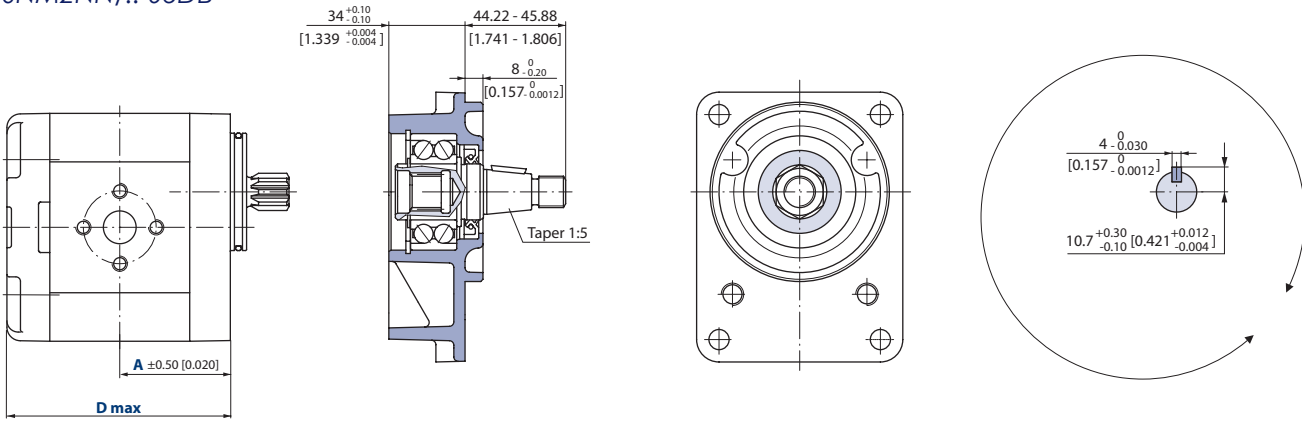

SNM2NN/.. 9HDB
SNM2NN/.. 03DB

Outrigger bearing 9HDB

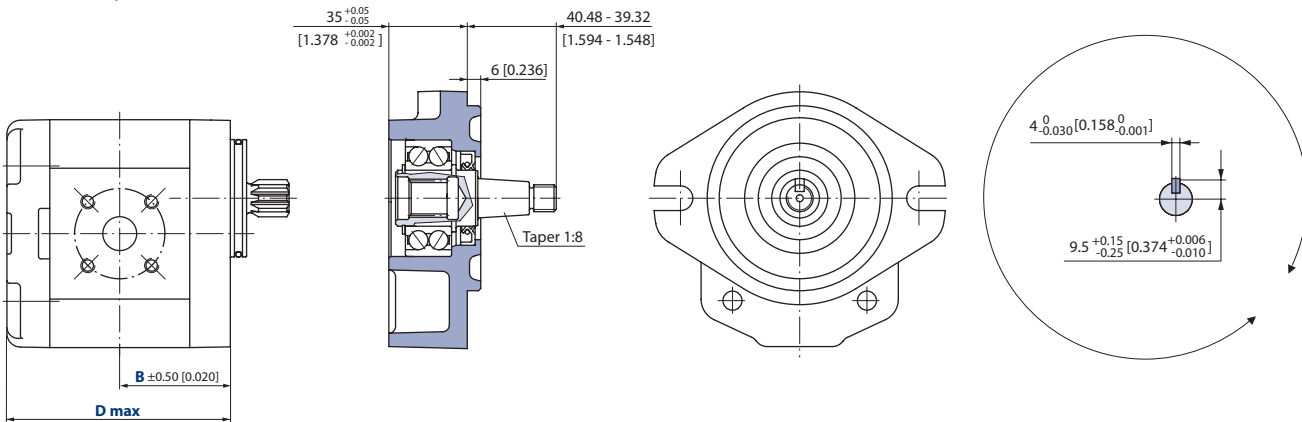

P005 277E

Dimensions

Frame size		6,0	8,0	011	014	017	019	022	025
Dimension	A	45 [1.772]	45 [1.772]	49 [1.929]	52 [2.047]	52 [2.047]	56 [2.205]	59 [2.323]	59 [2.323]
	B	38.6 [1.520]	40.6 [1.598]	45 [1.772]	45 [1.772]	45 [1.772]	45 [1.772]	52.5 [2.067]	62 [2.441]
	C	45 [1.772]	47 [1.850]	49 [1.929]	52 [2.047]	54 [2.126]	56 [2.205]	59 [2.323]	61 [2.402]
	D	93.5 [3.681]	97.5 [3.839]	101.5 [3.996]	107.5 [4.232]	111.5 [4.390]	115.5 [4.574]	121.5 [4.783]	125.5 [4.941]
	E	85 [3.346]	89 [3.504]	93 [3.661]	99 [3.897]	103 [4.055]	107 [4.212]	113 [4.448]	117 [4.606]

**SNM2NN, SNU2NN –
01DA, 01FA and 01BA**

Standard porting drawing for 01DA, 01FA and 01BA

mm
[in]

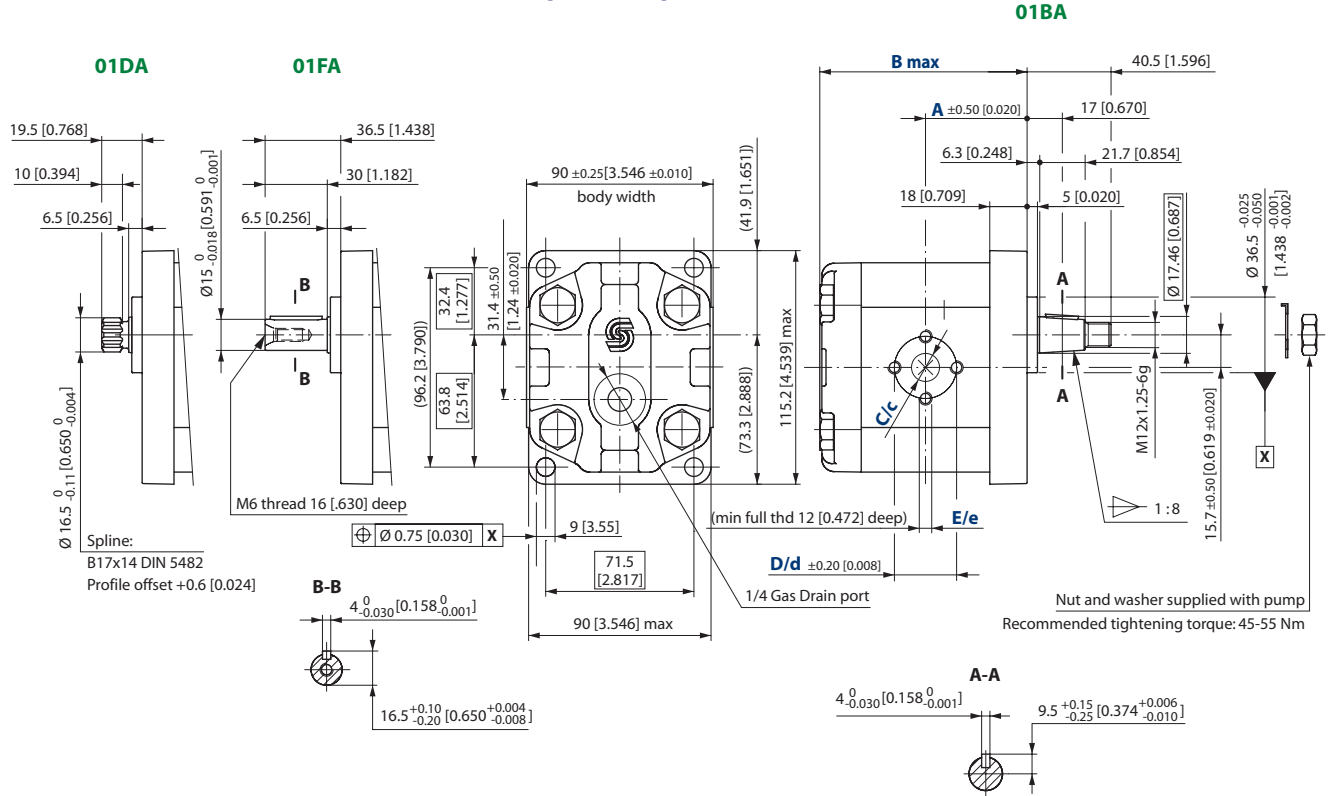

P005 070E

For unidirectional motors no case drain hole into the rear cover.

Bidirectional motors dimensions – 01DA, 01FA and 01BA

Frame size	6,0*	8,0	011	014	017	019	022	025
Dimension	A	45 [1.771]	49 [1.929]	52 [2.047]	56 [2.204]	59 [2.322]		
	B	93.5 [3.681]	97.5 [3.838]	101.5 [3.996]	107.5 [4.232]	111.5 [4.389]	121.5 [4.783]	125.5 [4.940]
Inlet/Outlet	C/c	13.5 [0.531]			20 [0.787]			23.5 [0.925]
	D/d	30 [1.181]			40 [1.58]			
	E/e	M6			M8			

* Before choosing this frame size, please apply to Turolia OCG technical department.

For unidirectional SNU2NN dimensions, see *SNU2NN ports*, page 36.

Model code examples and maximum shaft torque

Flange/drive gear	Model code example	Maximum shaft torque
01DA	SNM2NN/8,0BN01DAM1C3C3NNNN/NNNNN	90 N•m [797 lb•in]
01FA	SNM2NN/022BN01FAM1C7C7NNNN/NNNNN	90 N•m [797 lb•in]
01BA	SNM2NN/017BN01BAM1C7C7NNNN/NNNNN	150 N•m [1328 lb•in]

For further details on ordering, see *Model Code*, pages 28÷30.

**SNM2NN, SNU2NN –
02DB and 02AA**

Standard porting drawing for 02DB and 02AA

mm
[in]

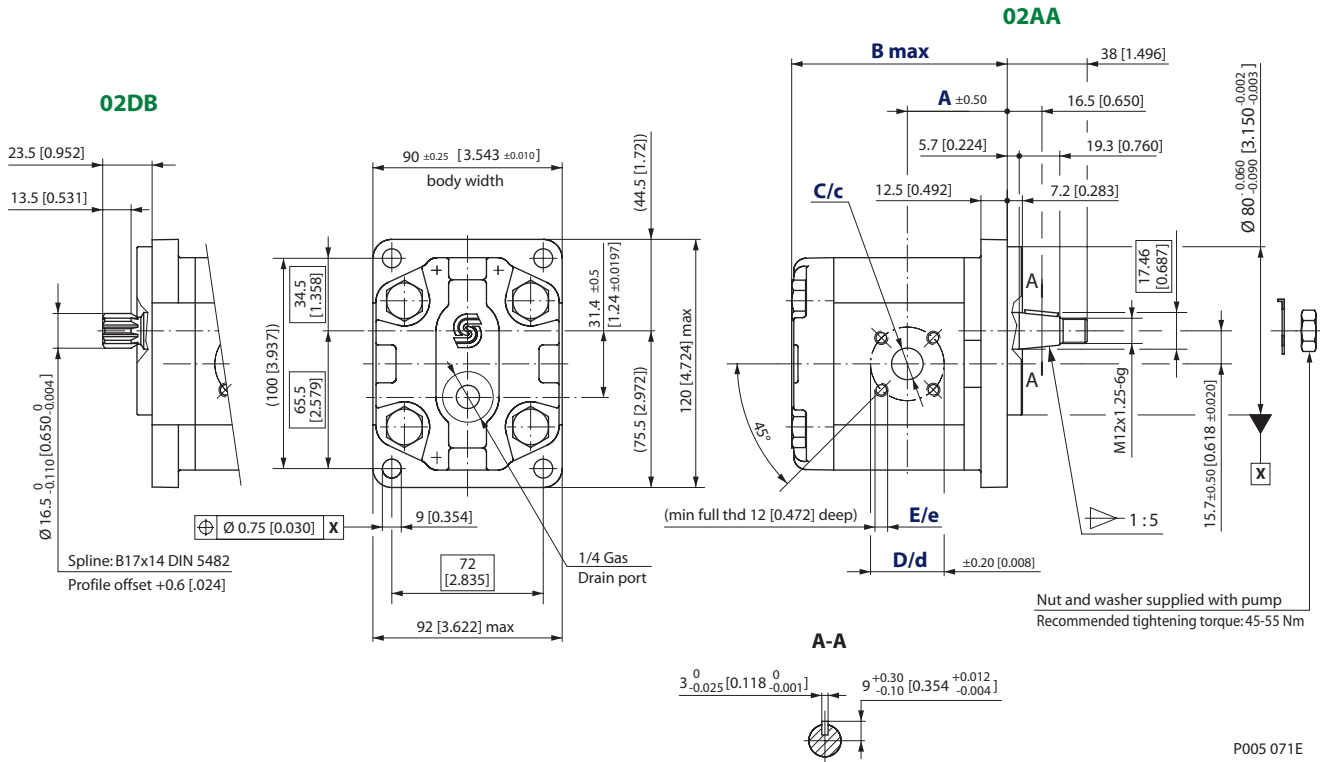

P005 071E

For unidirectional motors no case drain hole into the rear cover.

Bidirectional motors dimensions – 02DB and 02AA

Frame size		6,0*	8,0	011	014	017	019	022	025
Dimension	A	41.1 [1.618]	43.1 [1.697]	47.5 [1.870]	47.5 [1.870]	47.5 [1.870]	47.5 [1.870]	55 [2.165]	64.5 [2.539]
	B	96 [3.780]	100 [3.937]	104 [4.094]	110 [4.331]	114 [4.488]	118 [4.646]	124 [4.882]	128 [5.039]
Inlet/Outlet	C/c	15 [0.591]						20 [0.79]	
	D/d	35 [1.38]						40 [1.58]	
	E/e	M6							

* Before choosing this frame size, please apply to Turolia OCG technical department.

For unidirectional SNU2NN dimensions, see *SNU2NN ports*, page 36.

Model code examples and maximum shaft torque

Flange/drive gear	Model code example	Maximum shaft torque
02DB	SNM2NN/025BN02DBM1B7B7NNNN/NNNNN	90 N•m [797 lb•in]
02AA	SNM2NN/8,0BN02AAM1B5B5NNNN/NNNNN	140 N•m [1239 lb•in]

For further details on ordering, see *Model Code*, pages 28÷30.

**SNM2NN, SNU2NN –
03CA**

Standard porting drawing for 03CA

mm
[in]

03CA

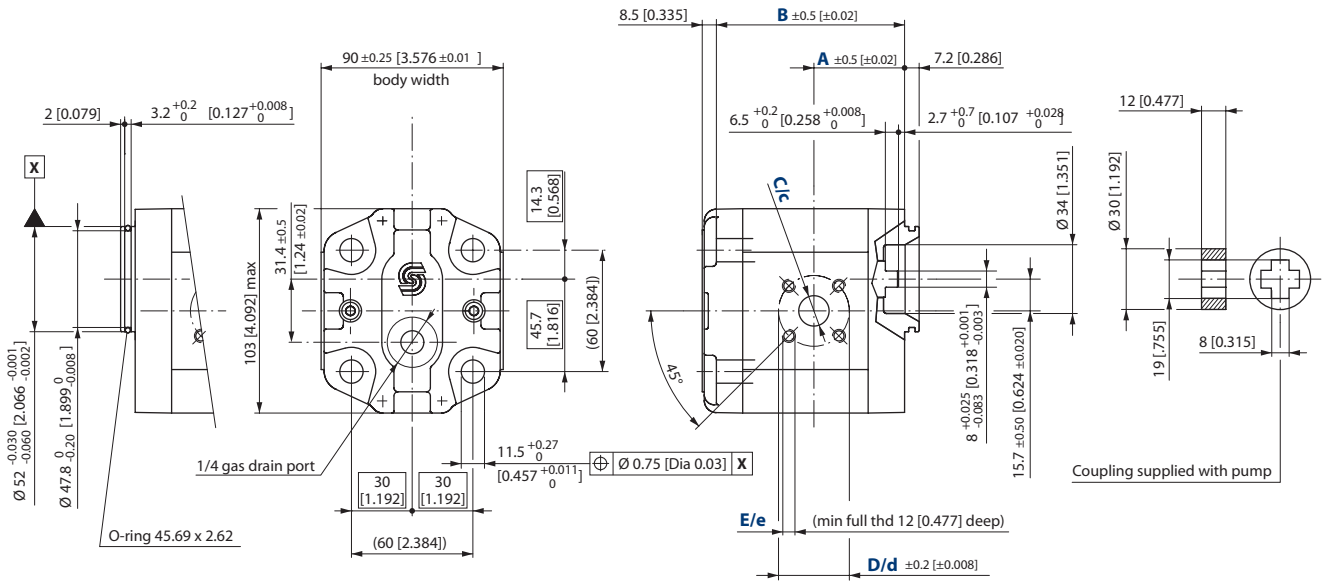

P005 072E

For unidirectional motors no case drain hole into the rear cover.

Bidirectional motors dimensions – 03CA

Frame size	6,0*	8,0	011	014	017	019	022	025	
Dimension	A	38.6 [1.520]	40.6 [1.598]	45 [1.772]			52.5 [2.067]	62 [2.441]	
	B	85 [3.364]	89 [3.503]	93 [3.661]	99 [3.897]	103 [4.055]	107 [4.212]	113 [4.448]	117 [4.606]
Inlet/Outlet	C/c	15 [0.591]					20 [0.79]		
	D/d	35 [1.38]					40 [1.58]		
	E/e	M6							

* Before choosing this frame size, please apply to Turolia OCG technical department.

For unidirectional SNU2NN dimensions, see *SNU2NN ports*, page 36.

Model code examples and maximum shaft torque

Flange/drive gear	Model code example	Maximum shaft torque
03CA	SNM2NN/014BN03CAM3B5B5NNNN/NNNNN	70 N•m [620 lb•in]

For further details on ordering, see *Model Code*, pages 28÷30.

SNM2NN, SNU2NN-04DB/ 05DB and 04AA/05AA Standard porting drawing for 04DB/05DB and 04AA/05AA

mm
[in]

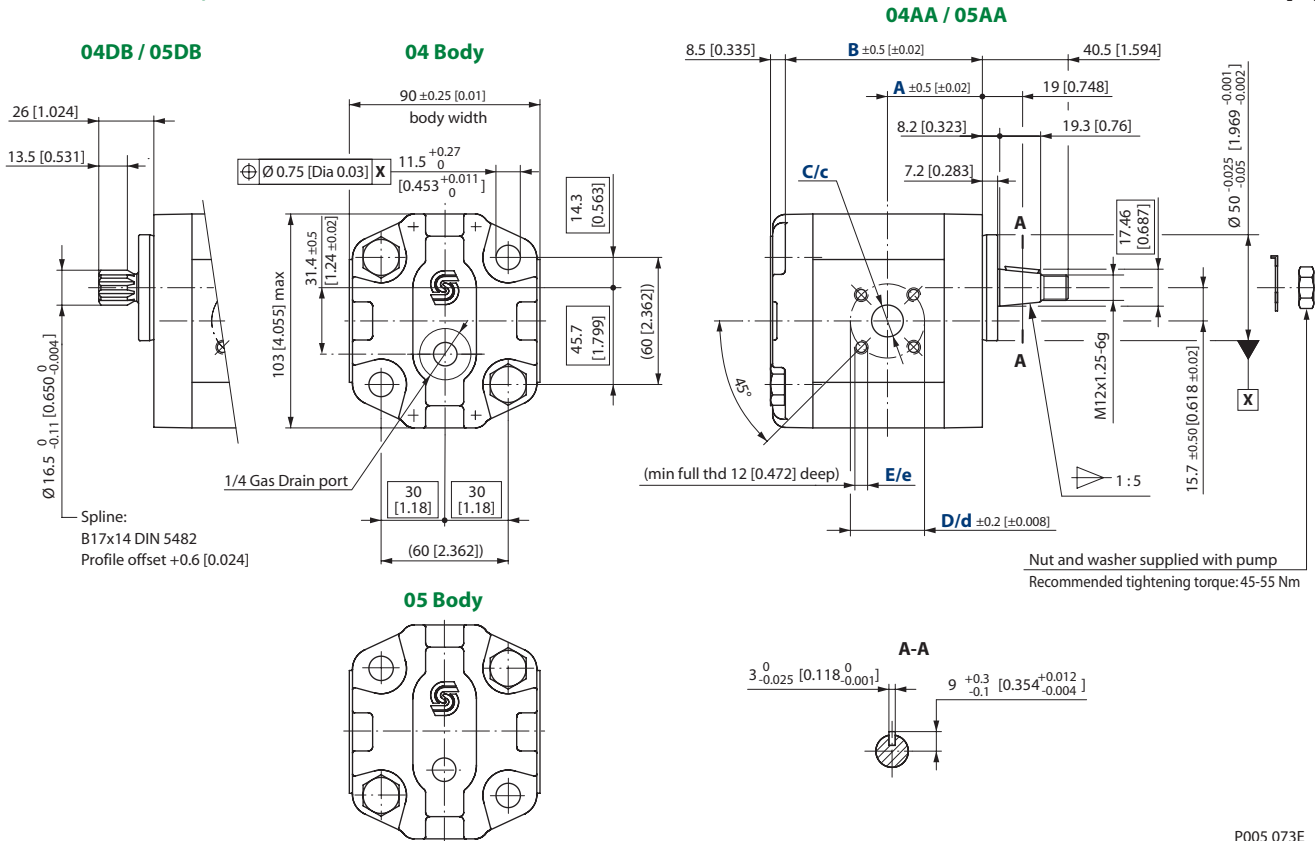

P005 073E

For unidirectional motors no case drain hole into the rear cover.

Bidirectional motors dimensions – 04/05DB and 04/05AA

Frame size		6,0*	8,0	011	014	017	019	022	025
Dimension	A	38.6 [1.520]	40.6 [1.598]	45 [1.772]			52.5 [2.067]	62 [2.441]	
	B	85 [3.364]	89 [3.503]	93 [3.661]	99 [3.897]	103 [4.055]	107 [4.212]	113 [4.448]	117 [4.606]
Inlet/Outlet	C/c	15 [0.591]					20 [0.79]		
	D/d	35 [1.38]					40 [1.58]		
	E/e	M6							

* Before choosing this frame size, please apply to Turolia OCG technical department.

For unidirectional SNU2NN dimensions, see *SNU2NN ports*, page 36.

Model code examples and maximum shaft torque

Flange/drive gear	Model code example	Maximum shaft torque
04DB	SNM2NN/8,0BN04DBAM1B5B5NNNN/NNNNN	130 N•m [1151 lb•in]
05DB	SNM2NN/017BN05DBM1B5B5NNNN/NNNNN	
04AA	SNM2NN/8,0BN04AAM1B5B5NNNN/NNNNN	140 N•m [1239 lb•in]
05AA	SNM2NN/017BN05AAM1B5B5NNNN/NNNNN	

For further details on ordering, see *Model Code*, pages 28÷30.

**SNM2NN, SNU2NN,
SKU2NN – 06SA, 06GA**

Standard porting drawing for 06SA and 06GA

mm
[in]

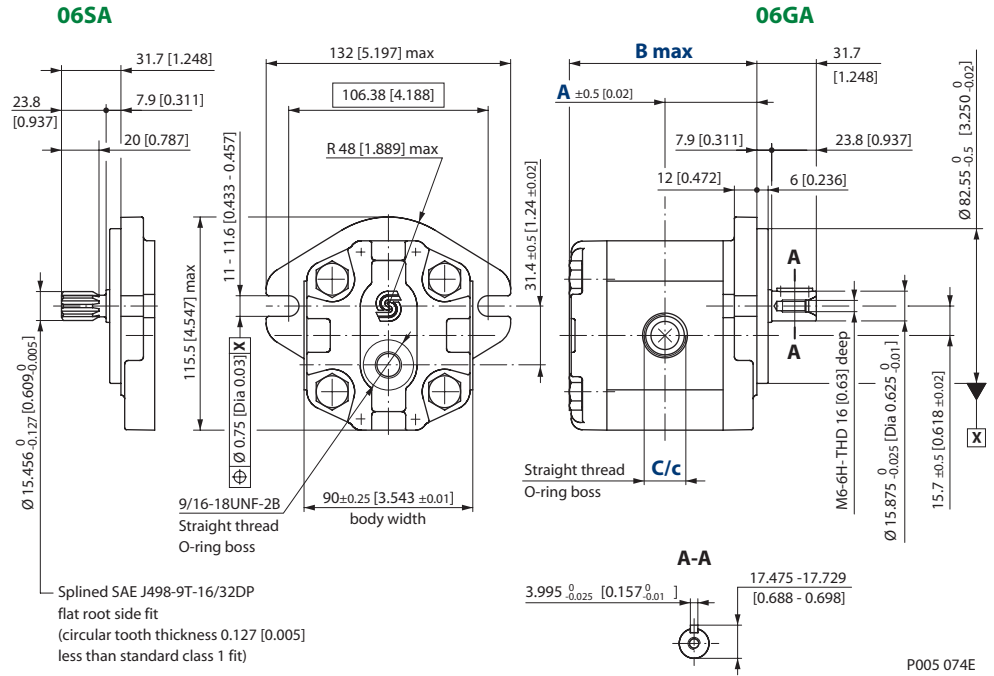

P005 074E

For unidirectional motors no case drain hole into the rear cover.

Bidirectional motors dimensions – 06SA and 06GA

Frame size	6,0	8,0	011	014	017	019	022	025	
Dimension	A	45 [1.772]	47 [1.850]	49 [1.920]	52 [2.047]	54 [2.205]	56 [2.205]	59 [2.323]	61 [2.402]
	B	93.5 [3.681]	97.5 [3.839]	101.5 [3.996]	107.5 [4.232]	111.5 [4.390]	115.5 [4.547]	121.5 [4.783]	125.5 [4.941]
Inlet/Outlet	C/c 7/8-14UNF-2B, 16.7 [0.658] deep						1 1/16-12UNF-2B, 18.0 [0.709] deep		

* Before choosing this frame size, please apply to Turolia OCG technical department.

For unidirectional SNU2NN dimensions, see *SNU2NN ports*, page 36.

Model code examples and maximum shaft torque

Flange/drive gear	Model code example	Maximum shaft torque
06SA	SNM2NN/8,0BN06SAM1E5E5NNNN/NNNNN	75 N·m [664 lb-in]
06GA	SNM2NN/017BN06GAM6E5E5NNNN/NNNNN	80 N·m [708 lb-in]

For further details on ordering, see *Model Code*, pages 28÷30.

Gear Motors • Group 3 Technical Information General Information

Motor design

SNM3NN

SNM3NN is the Group 3 bidirectional motor available in the whole displacements range from 22 up to 90 cm³/rev [1.35 up to 5.38 in³/rev].

Configurations include European and SAE flanges and shafts (01BA, 01FA, 01DA, 02AA, 02FA, 02DB, 03BB, 03FB, 06AA, 06DD, 07BC, 07GA, 07SA).

SNU3NN

SNU3NN is the Group 3 unidirectional motor available in the whole displacements range from 22 up to 90 cm³/rev [1.35 up to 5.38 in³/rev].

The SNU3NN motor construction is derived from the correspondent pump SNP3.

Configurations include European and SAE flanges and shafts (01BA, 01FA, 01DA, 02AA, 02FA, 02DB, 03BB, 03FB, 03DB, 06AA, 06SA, 07BC, 07GA, 07SA).

SNM3NN 01BA

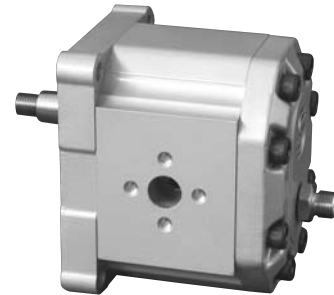

F005 217

SNU3NN 01BA (cut away)

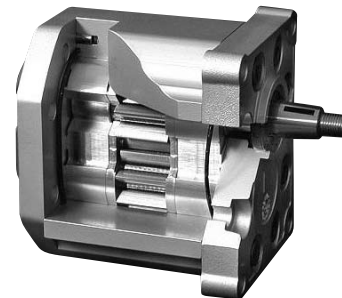

F005 073

Technical data

This table details the technical data for Group 3 gear motors based on the model and displacement configuration.

Technical data for Group 3 gear motors

		Frame size									
		022	026	033	038	044	048	055	063	075	090
Displacement	cm ³ /rev [in ³ /rev]	22.1 [1.35]	26.2 [1.60]	33.1 [2.02]	37.9 [2.32]	44.1 [2.69]	48.3 [2.93]	55.2 [3.36]	63.4 [3.87]	74.4 [4.54]	88.2 [5.38]
SNU3NN (unidirectional)											
Peak pressure	bar [psi]	270 [3915]	270 [3915]	270 [3915]	270 [3915]	270 [3915]	250 [3625]	230 [3336]	210 [3045]	190 [2755]	170 [2465]
Rated pressure		250 [3625]	250 [3625]	250 [3625]	250 [3625]	250 [3625]	230 [3336]	210 [3045]	190 [2755]	170 [2465]	150 [2175]
Minimum speed	min ⁻¹ (rpm)	800	800	800	800	800	800	800	600	600	600
Maximum speed		2500	2500	2500	2500	2300	2300	2300	2300	2100	2100
SNM3NN (bidirectional) motor in parallel											
Peak pressure	bar [psi]	270 [3915]	270 [3915]	270 [3915]	270 [3915]	270 [3915]	250 [3625]	230 [3336]	210 [3045]	190 [2755]	170 [2465]
Rated pressure		250 [3625]	250 [3625]	250 [3625]	250 [3625]	250 [3625]	230 [3336]	210 [3045]	190 [2755]	170 [2465]	150 [2175]
Minimum speed	min ⁻¹ (rpm)	800	800	800	800	800	800	800	800	800	800
Maximum speed		2500	2500	2500	2500	2300	2300	2300	2300	2100	2100
SNM3NN (bidirectional) motor in series											
Peak pressure	bar [psi]	250 [3625]	250 [3625]	250 [3625]	250 [3625]	250 [3625]	230 [3336]	210 [3045]	190 [2755]	170 [2465]	150 [2175]
Rated pressure		250 [3625]	250 [3625]	250 [3625]	250 [3625]	250 [3625]	230 [3336]	210 [3045]	190 [2755]	170 [2465]	150 [2175]
Minimum speed	min ⁻¹ (rpm)	800	800	800	800	800	800	800	800	800	800
Maximum speed		2500	2500	2500	2500	2300	2300	2200	2100	2100	2100
All (SNU3NN, SNM3NN)											
Weight	kg [lb]	6.8 [15.0]	6.8 [15.0]	7.2 [15.8]	7.3 [16.1]	7.5 [16.5]	7.6 [16.8]	7.8 [17.3]	8.1 [17.9]	8.5 [18.7]	8.9 [19.6]
Moment of inertia of rotating components	x 10 ⁻⁶ kg·m ² [x 10 ⁶ lb·ft ²]	198 [4698]	216 [5126]	246 [5837]	267.2 [6341]	294.2 [6981]	312.2 [7408]	342.3 [8123]	378.3 [8977]	426.4 [10 118]	486.5 [11 545]

1 kg·m² = 23.68 lb·ft²

⚠ Caution

The rated and peak pressure mentioned are for motors with flanged ports only. When threaded ports are required a de-rated performance has to be considered. To verify the compliance of an high pressure application with a threaded ports pump apply to a Turolia OCG representative.

Model code



A Type

SNM3NN	Standard bidirectional gear motor
SNM3GN	Bidirectional gear motor with anti-cavitation check valve
SNU3NN	Standard unidirectional gear motor
SNU3GN	Unidirectional gear motor with anti-cavitation check valve

B Displacement

022	22.1 cm ³ /rev [1.35 in ³ /rev]
026	26.2 cm ³ /rev [1.60 in ³ /rev]
033	33.1 cm ³ /rev [2.02 in ³ /rev]
038	37.9 cm ³ /rev [2.32 in ³ /rev]
044	44.1 cm ³ /rev [2.69 in ³ /rev]
048	48.3 cm ³ /rev [2.93 in ³ /rev]
055	55.1 cm ³ /rev [3.36 in ³ /rev]
063	63.4 cm ³ /rev [3.87 in ³ /rev]
075	74.4 cm ³ /rev [4.54 in ³ /rev]
090	88.2 cm ³ /rev [5.38 in ³ /rev]

C Direction of rotation

R	Right hand (clockwise)
L	Left hand (counterclockwise)
B	Bidirectional

D Version

N	Standard version
----------	------------------

E Mounting flange and shaft

Code	Description	SNM3NN	SNU3NN	SNM3GN
01BA	European 01 4-bolt flange / Tapered shaft 1:8	●	●	●
02BA	European 02 4-bolt flange / Tapered shaft 1:8	●	○	○
03BB	European 03 4-bolt flange / Tapered shaft 1:8	●	●	○
06AA	German 4-bolt flange / Tapered shaft 1:5	●	●	○
07BC	SAE B flange / Tapered shaft 1:8	●	○	○
01FA	European 01 4-bolt flange / Parallel shaft 20 mm [0.787 in]	●	●	○
02FA	European 02 4-bolt flange / Parallel shaft 20 mm [0.787 in]	○	○	○
03FB	European 03 4-bolt flange / Parallel shaft 22 mm [0.866 in]	●	○	○
07GA	SAE B flange / Parallel shaft 22.225 mm [0.875 in]	●	●	○
01DA	European 01 4-bolt flange / DIN splined shaft	●	○	○
02DA	European 02 4-bolt flange / DIN splined shaft	○	○	○
06DD	German 4-bolt flange / DIN splined shaft	●	○	○
07SA	SAE B flange / SAE splined shaft	●	●	○

Legend:

- = Standard
- = Optional
- = Not Available

Model code
(continued)

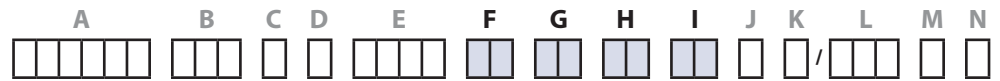

F Rear cover

P1	Standard cover for unidirectional gear motor
M1	Standard cover for motor drain M14x1.5
M6	Cover for motor drain 1/16-18UNF-2B

G Inlet port

H Outlet port

A2	18.5 x 22.23 x 47.63 x 3/8-16UNC	SAE flanged port
A3	25.4 x 26.19 x 52.37 x 3/8-16UNC	
A4	31.8 x 30.18 x 58.72 x 7/16-14UNC	
A5	37.5/27 x 35.71 x 69.85 x 1/2-13UNC	
B7	20 x 40 x M6	Flanged port, 4-threaded holes in X pattern, in the center or off-set of the body
BA	18 x 55 x M8	
BB	27 x 55 x M8	
BC	36/27 x 55 x M8	
C3	13.5 x 30 x M6	Flanged port, 4-threaded holes in + pattern, (European standard ports)
C7	20 x 40 x M8	
CA	27 x 51 x M10	
CD	36 x 62 x M10	
CZ	27 x 51 x M10 (2 vertical holes)	Threaded SAE O-ring boss port
E6	1-1/16-12UN	
E8	1-5/16-12UN	
E9	1-5/8-12UN	
EA	1-7/8-12UN	Threaded GAS (BSPP) port
F5	3/4 GAS	
F6	1 GAS	
F7	1-1/4 GAS	Flanged port, 4-threaded holes in + pattern
G7	20 x 40 x 5/16-18UNC	
GA	27 x 51 x 3/8-16UNC	
M6	31 x 30,18 x 58,72 x M10	SAE flanged port - Threaded metric port ISO6149
MF	25 x 52,37 x 26,19 x M8	
MH	31 x 30,18 x 58,72 x M10 deep 18 mm	
MN	31 x 30,18 x 58,72 x M10 deep 12 mm	

For more information see *Port dimensions*, pages 58-60.

I Port position and variant body

NN	Std from catalogue
YY	Port Bx-Bx for flange SAE off-set from center of body as per catalogue
ZZ	Port type Bx-Bx in center of the body

**Model code
(continued)**



J Sealing

N	Standard Buna seal
D	Buna+VITON shaft seal with dust lip

K Screws

N	Standard screws
A	Galvanized screws+nuts-washers
B	DACROMET/GEOMET screws

L Set valve

NNN	No valve
V**	Integral RV-Pressure setting. Motor speed for relief valve setting (min ⁻¹ [rpm])

M Marking

N	Standard marking
A	Standard marking + Customer Code
Z	Without marking

N Mark position

N	Standard marking position
A	Mark on the bottom ref. to drive gear

Motor performance graphs

The graphs on the next pages provide typical inlet flow and output power for Group 3 motors at various working pressures. Data were taken using ISO VG46 petroleum / mineral based fluid at 50 °C [122 °F] (viscosity = 28 mm²/s [132 SUS]).

SNM3NN/022 motor performance graph

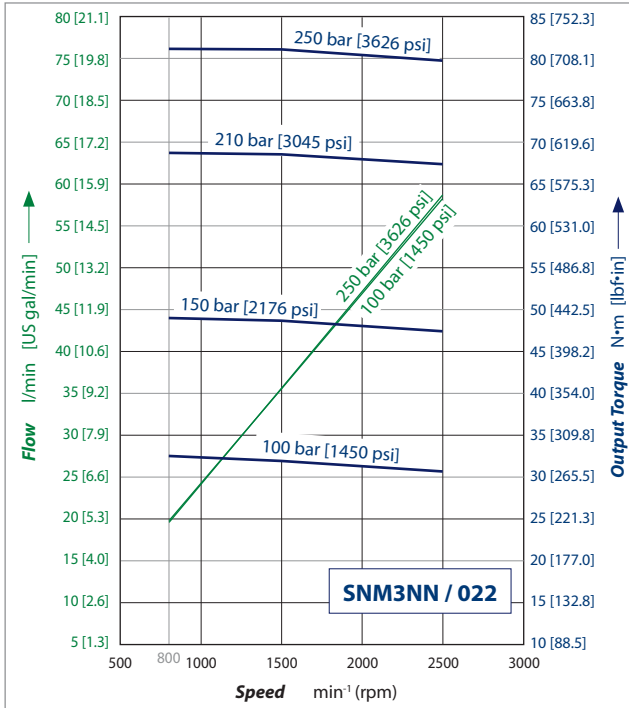

SNM3NN/026 motor performance graph

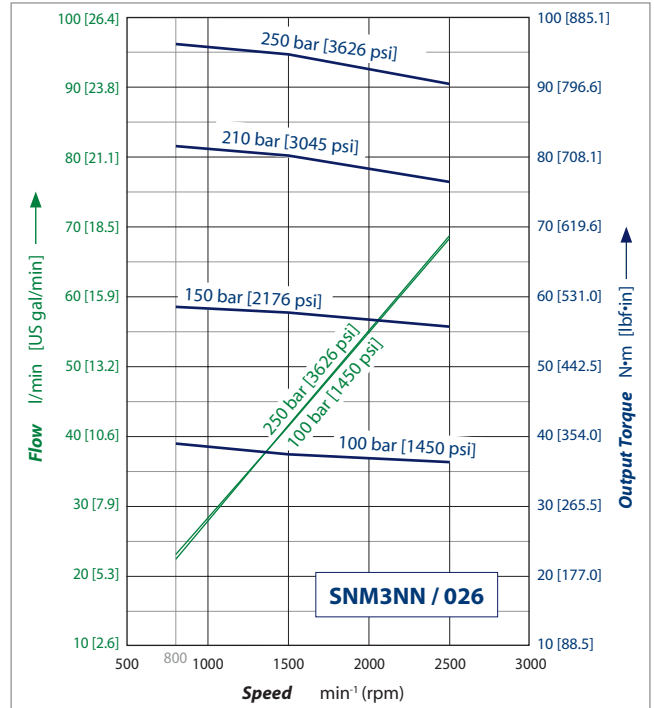

SNM3NN/033 motor performance graph

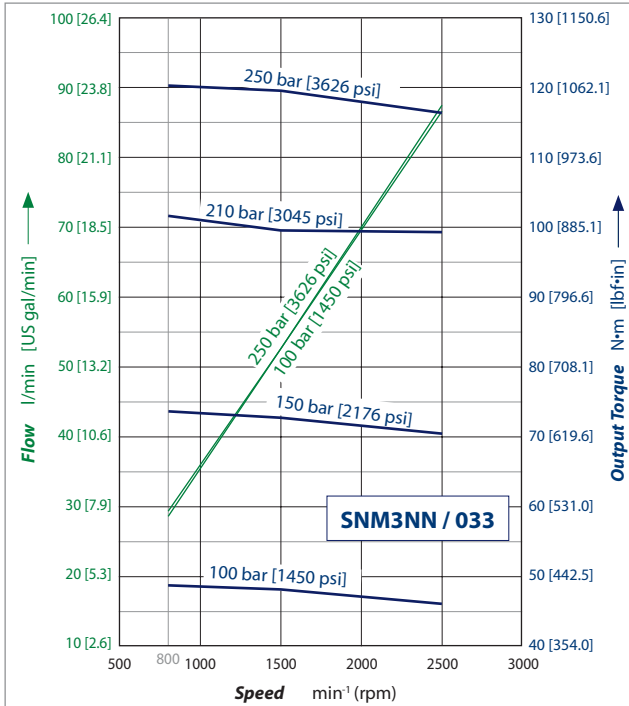

SNM3NN/038 motor performance graph

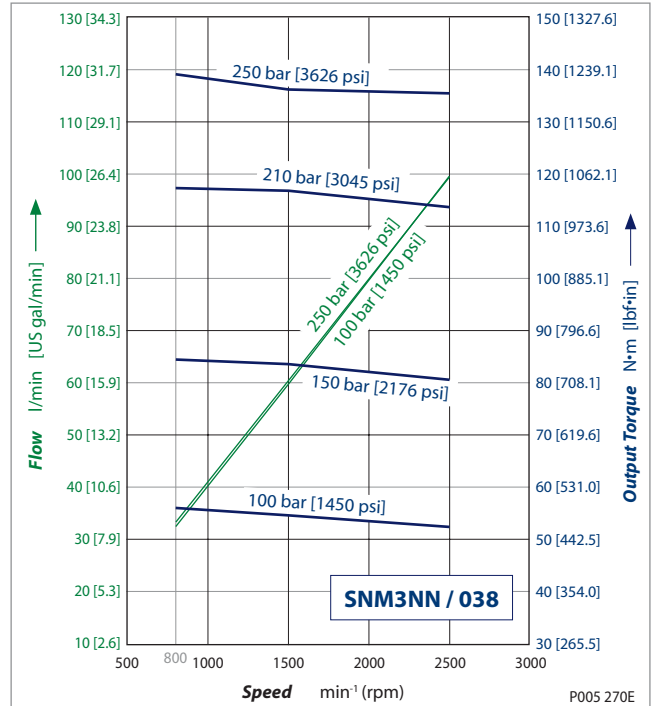

Motor performance graphs (continued)

SNM3NN/044 motor performance graph

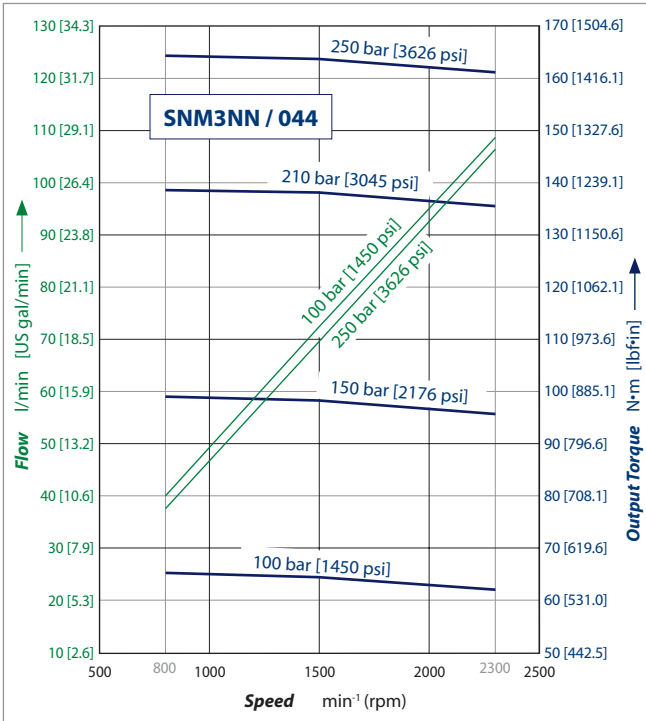

SNM3NN/048 motor performance graph

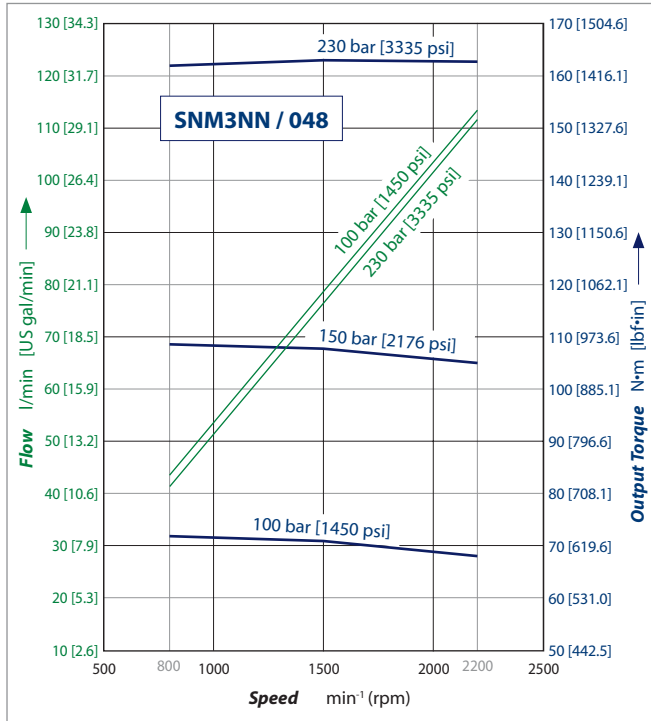

SNM3NN/055 motor performance graph

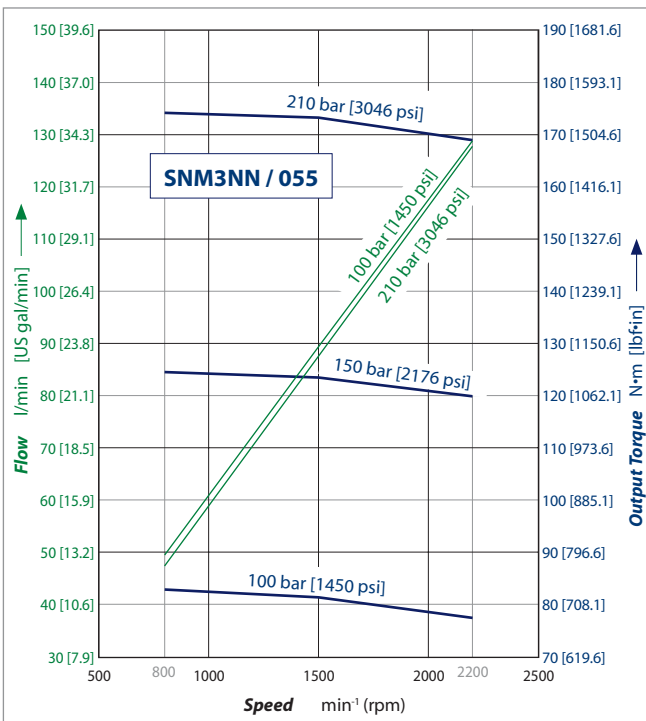

SNM3NN/063 motor performance graph

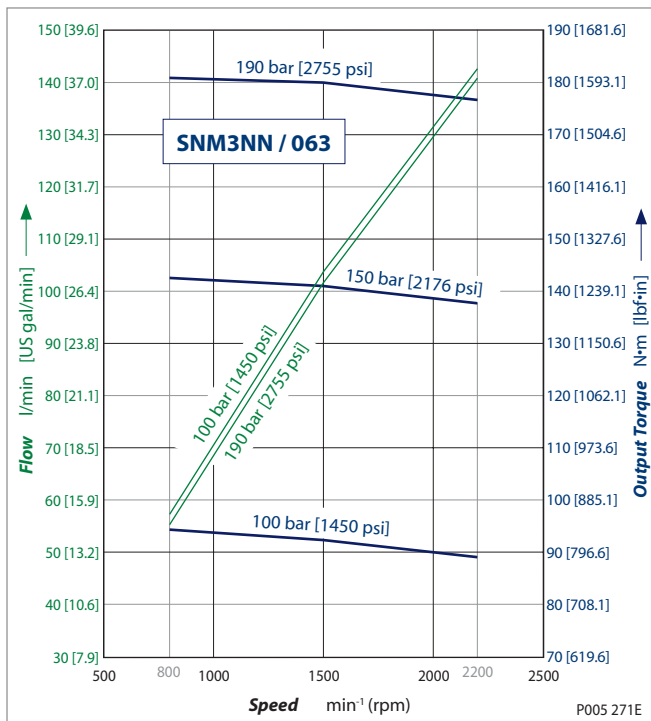

Motor performance graphs (continued)



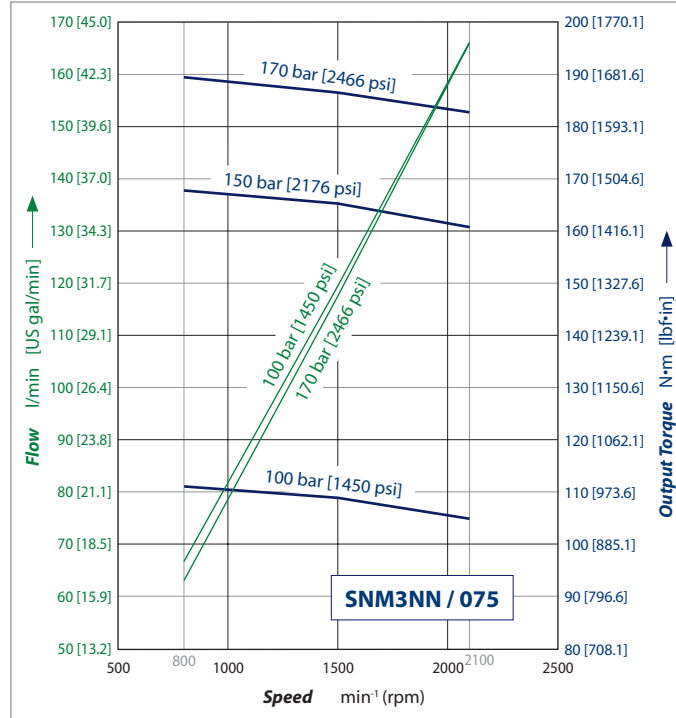



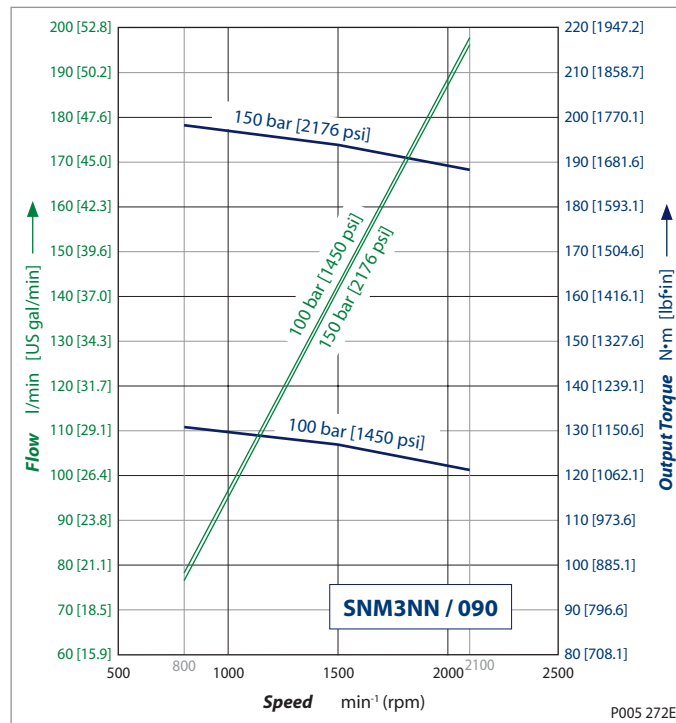



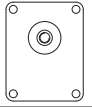
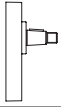

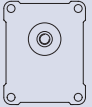
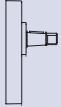

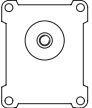
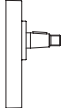
SNM3NN/075 motor performance graph

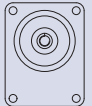
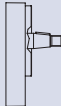
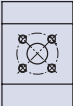
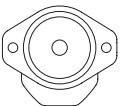
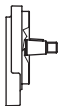
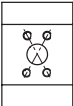
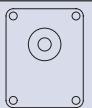
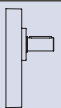

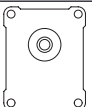
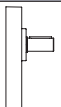
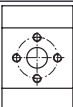
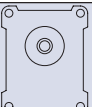
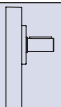
SNM3NN/090 motor performance graph

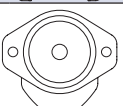
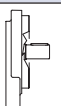
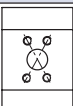
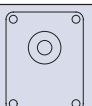
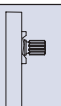

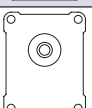
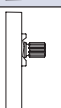
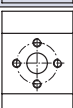
Flange, shaft and port configurations

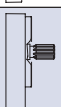
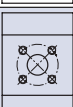
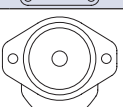
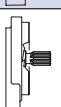
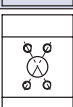
Motor	Code	Flange	Shaft	Port
SNM3NN SNU3NN SNM3GN	01BA	pilot Ø 50.8 mm [2.0 in] European 01 4-bolt 	1:8 tapered 	European flanged port + pattern 
SNM3NN SNU3NN SNM3GN	02BA	pilot Ø 50.8 mm [2.0 in] European 02 4-bolt 	1:8 tapered 	European flanged port + pattern 
SNM3NN SNU3NN SNM3GN	03BB	pilot Ø 60.3 mm [2.374 in] European 03 4-bolt 	1:8 tapered 	European flanged port + pattern 
SNM3NN SNU3NN SNM3GN	06AA	pilot Ø 105 mm [4.133 in] German 4-bolt 	1:5 tapered 	German std ports port X pattern 
SNM3NN SNU3NN SNM3GN	07BC	SAE B pilot Ø 101.6 2-bolt 	1:8 tapered 	Vertical four bolt flanged port 
SNM3NN SNU3NN SNM3GN	01FA	pilot Ø 50.8 mm [2.0 in] European 01 4-bolt 	Ø 20 mm [0.787 in] parallel 	European flanged port + pattern 
SNM3NN SNU3NN SNM3GN	02FA	pilot Ø 50.8 mm [2.0 in] European 02 4-bolt 	Ø 20 mm [0.787 in] parallel 	European flanged port + pattern 
SNM3NN SNU3NN SNM3GN	03FB	pilot Ø 60.3 mm [2.374 in] European 03 4-bolt 	Ø 22 mm [0.866 in] parallel 	European flanged port + pattern 
SNM3NN SNU3NN SNM3GN	07GA	SAE B pilot Ø 101.6 mm 2-bolt 	Ø 22.225 mm [0.875 in] parallel 	Vertical four bolt flanged port 
SNM3NN SNU3NN SNM3GN	01DA	pilot Ø 50.8 mm [2.0 in] European 01 4-bolt 	Splined shaft 13T – m 1.60 DIN 5482 – B22 x 19 	European flanged port + pattern 
SNM3NN SNU3NN SNM3GN	02DB	pilot Ø 50.8 mm [2.0 in] European 02 4-bolt 	Splined shaft 13T – m 1.60 DIN 5482 – B22 x 19 	European flanged port + pattern 
SNM3NN SNU3NN SNM3GN	06DD	pilot Ø 105 mm [4.133 in] German 4-bolt 	Splined shaft 15T – m 1.60 DIN 5482 – B28 x 25 	German std ports port X pattern 
SNM3NN SNU3NN SNM3GN	07SA	SAE B pilot Ø 101.6 mm 2-bolt 	Splined shaft SAE J498 13T – 16/32DP 	Vertical four bolt flanged port 

Shaft and flange availability

Shaft and flange availability and torque capability

This table details the standard Group 3 shafts and flange combinations that are currently available with the maximum shaft torque limits.

Shaft and flange availability and torque capability

Shaft		Mounting flange code with maximum torque in Nm [lb·in]				
Code	Description	01	02	03	06	07
AA	Taper 1:5	–	–	–	300 [2655]	–
BA	Taper 1:8	350 [3097]	350 [3097]	–	–	–
BB	Taper 1:8	–	–	500 [4425]	–	–
BC	Taper 1:8	–	–	–	–	300 [2655]
DA	Spline 13T DIN 5482-B22X19	290 [2566]	290 [2566]	–	–	–
DD	Spline 15T DIN 5482-B28X25	–	–	–	450 [3982]	–
SA	SAE spline 13T 16/32p	–	–	–	–	270 [2389]
FA	Parallel ø20 mm	210 [1858]	210 [1858]	–	–	–
FB	Parallel ø22.225 mm	–	–	300 [2655]	–	–
GA	Parallel ø22.225 mm	–	–	–	–	230 [2035]

Ports dimensions

Bidirectional motor ports

Available ports for Group 3 bidirectional motors

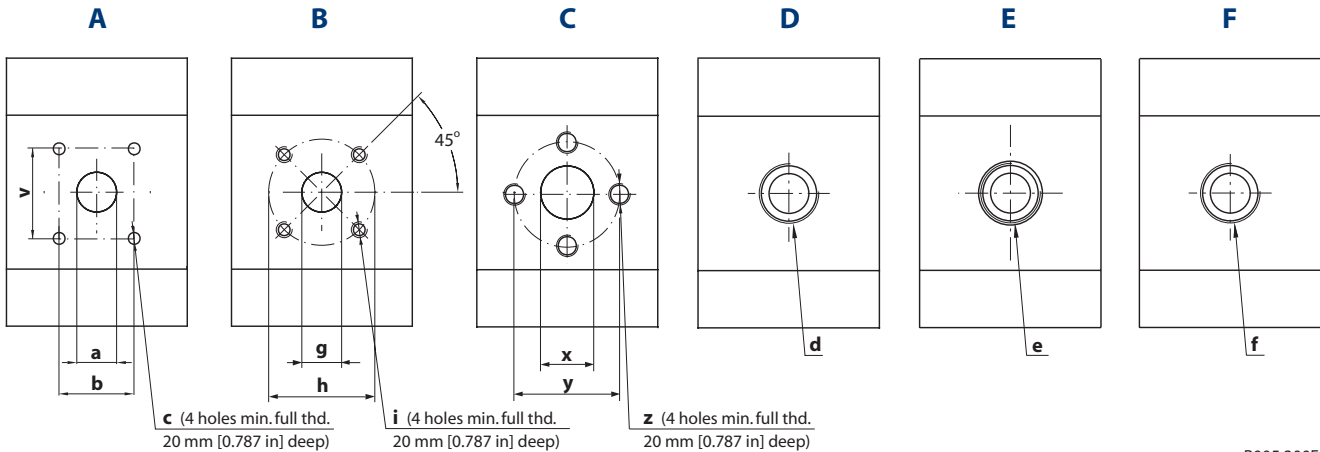

P005 300E

Ports dimensions for bidirectional motors SNM3NN

Port type	A				B			C			D	E	F	
Dimensions	a	b	v	c	g	h	i	x	y	z	d	e	f	
Frame size	022	25.4 [1.0]	26.19 [1.031]	52.37 [2.061]	3/8-16UNC-2B	27 [1.063]	55 [2.165]	M8	20 [0.79]	40 [1.58]	M8	M26x1.5	1 5/16-12UN-2B	3/4 Gas (BSPP)
	026	25.4 [1.0]	26.19 [1.031]	52.37 [2.061]	3/8-16UNC-2B	27 [1.063]	55 [2.165]	M8	20 [0.79]	40 [1.58]	M8	M26x1.5	1 5/16-12UN-2B	3/4 Gas (BSPP)
	033	31.8 [1.251]	30.18 [1.188]	58.72 [2.311]	7/16-14UNC-2B	27 [1.063]	55 [2.165]	M8	27 [1.063]	51 [2.008]	M10	M33x2	1 5/8-12UN-2B	1 Gas (BSPP)
	038	31.8 [1.251]	30.18 [1.188]	58.72 [2.311]	7/16-14UNC-2B	27 [1.063]	55 [2.165]	M8	27 [1.063]	51 [2.008]	M10	M33x2	1 5/8-12UN-2B	1 Gas (BSPP)
	044	31.8 [1.251]	30.18 [1.188]	58.72 [2.311]	7/16-14UNC-2B	27 [1.063]	55 [2.165]	M8	27 [1.063]	51 [2.008]	M10	M33x2	1 5/8-12UN-2B	1 Gas (BSPP)
	048	31.8 [1.251]	30.18 [1.188]	58.72 [2.311]	7/16-14UNC-2B	27 [1.063]	55 [2.165]	M8	27 [1.063]	51 [2.008]	M10	M33x2	1 5/8-12UN-2B	1 Gas (BSPP)
	055	31.8 [1.251]	30.18 [1.188]	58.72 [2.311]	7/16-14UNC-2B	27 [1.063]	55 [2.165]	M8	27 [1.063]	51 [2.008]	M10	M33x2	1 5/8-12UN-2B	1 Gas (BSPP)
	063	31.8 [1.251]	30.18 [1.188]	58.72 [2.311]	7/16-14UNC-2B	36 [1.417]	55 [2.165]	M8	36 [1.417]	62 [2.441]	M10	M33x2	1 5/8-12UN-2B	1 1/4 Gas (BSPP)
	075	31.8 [1.251]	30.18 [1.188]	58.72 [2.311]	7/16-14UNC-2B	36 [1.417]	55 [2.165]	M8	36 [1.417]	62 [2.441]	M10	M33x2	1 5/8-12UN-2B	1 1/4 Gas (BSPP)
	090	31.8 [1.251]	30.18 [1.188]	58.72 [2.311]	7/16-14UNC-2B	36 [1.417]	55 [2.165]	M8	36 [1.417]	62 [2.441]	M10	M33x2	1 5/8-12UN-2B	1 1/4 Gas (BSPP)
Drain	M14 x 1.5										9/16-18UNF-2B			

**Ports dimensions
(continued)**

Unidirectional motor ports

Available ports for Group 3 unidirectional motors

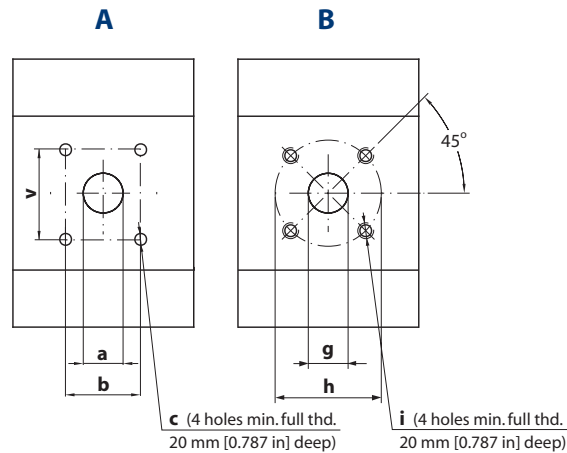

Ports dimensions for unidirectional motors SNU3NN

Port type		A				B			
Dimensions		a	b	c	v	g	h	i	
Frame size	022	Outlet	20 [0.79]	40 [1.58]	M8	3/8-16UNC-2B	27 [1.063]	55 [2.165]	M8
		Inlet	20 [0.79]	40 [1.58]	M8	3/8-16UNC-2B	18 [0.709]	55 [2.165]	M8
	026	Outlet	20 [0.79]	40 [1.58]	M8	3/8-16UNC-2B	27 [1.063]	55 [2.165]	M8
		Inlet	20 [0.79]	40 [1.58]	M8	3/8-16UNC-2B	18 [0.709]	55 [2.165]	M8
	033	Outlet	27 [1.063]	51 [2.008]	M10	7/16-14UNC-2B	27 [1.063]	55 [2.165]	M8
		Inlet	20 [0.79]	40 [1.58]	M8	3/8-16UNC-2B	18 [0.709]	55 [2.165]	M8
	038	Outlet	27 [1.063]	51 [2.008]	M10	7/16-14UNC-2B	27 [1.063]	55 [2.165]	M8
		Inlet	20 [0.79]	40 [1.58]	M8	3/8-16UNC-2B	18 [0.709]	55 [2.165]	M8
	044	Outlet	27 [1.063]	51 [2.008]	M10	7/16-14UNC-2B	27 [1.063]	55 [2.165]	M8
		Inlet	27 [1.063]	51 [2.008]	M10	3/8-16UNC-2B	18 [0.709]	55 [2.165]	M8
	048	Outlet	27 [1.063]	51 [2.008]	M10	7/16-14UNC-2B	27 [1.063]	55 [2.165]	M8
		Inlet	27 [1.063]	51 [2.008]	M10	3/8-16UNC-2B	18 [0.709]	55 [2.165]	M8
055	Outlet	27 [1.063]	51 [2.008]	M10	1/2-13UNC-2B	27 [1.063]	55 [2.165]	M8	
	Inlet	27 [1.063]	51 [2.008]	M10	7/16-14UNC-2B	18 [0.709]	55 [2.165]	M8	
063	Outlet	36 [1.417]	62 [2.441]	M10	1/2-13UNC-2B	36 [1.417]	55 [2.165]	M8	
	Inlet	27 [1.063]	51 [2.008]	M10	7/16-14UNC-2B	27 [1.063]	55 [2.165]	M8	
075	Outlet	36 [1.417]	62 [2.441]	M10	1/2-13UNC-2B	36 [1.417]	55 [2.165]	M8	
	Inlet	27 [1.063]	51 [2.008]	M10	7/16-14UNC-2B	27 [1.063]	55 [2.165]	M8	
090	Outlet	36 [1.417]	62 [2.441]	M10	1/2-13UNC-2B	36 [1.417]	55 [2.165]	M8	
	Inlet	27 [1.063]	51 [2.008]	M10	7/16-14UNC-2B	27 [1.063]	55 [2.165]	M8	

(the table is continued on the next page)

**Ports dimensions
(continued)**

Unidirectional motor ports

Available ports for Group 3 unidirectional motors

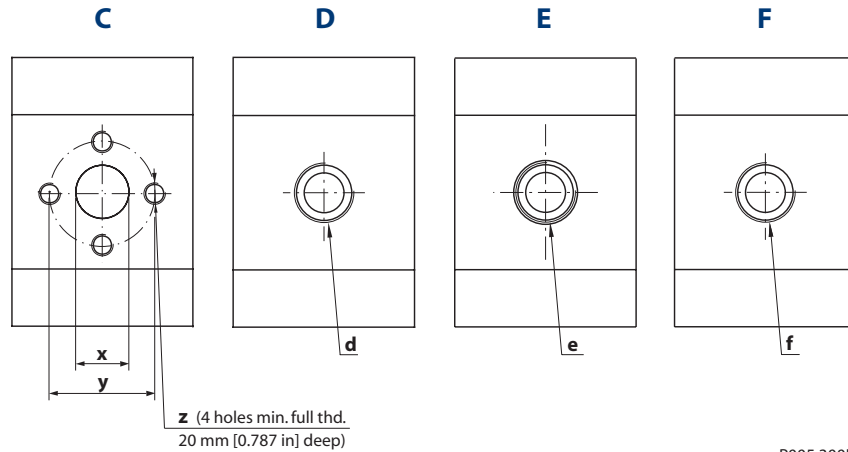

P005 300E

Ports dimensions for unidirectional motors SNU3NN

Port type		C			D	E	F	
Dimensions		x	y	z	d	e	f	
Frame size	022	Outlet	20 [0.79]	40 [1.58]	M8	M26 x 1.5	¾ Gas (BSPP)	1½-12UN-2B
		Inlet	20 [0.79]	40 [1.58]	M8	M26 x 1.5	¾ Gas (BSPP)	1½-12UN-2B
	026	Outlet	20 [0.79]	40 [1.58]	M8	M26 x 1.5	¾ Gas (BSPP)	1½-12UN-2B
		Inlet	20 [0.79]	40 [1.58]	M8	M26 x 1.5	¾ Gas (BSPP)	1½-12UN-2B
	033	Outlet	27 [1.063]	51 [2.008]	M10	M33x2	1 Gas (BSPP)	1½-12UN-2B
		Inlet	20 [0.79]	40 [1.58]	M8	M26 x 1.5	¾ Gas (BSPP)	1½-12UN-2B
	038	Outlet	27 [1.063]	51 [2.008]	M10	M33x2	1 Gas (BSPP)	1½-12UN-2B
		Inlet	20 [0.79]	40 [1.58]	M8	M26 x 1.5	¾ Gas (BSPP)	1½-12UN-2B
	044	Outlet	27 [1.063]	51 [2.008]	M10	M33 x 2	1 Gas (BSPP)	1½-12UN-2B
		Inlet	27 [1.063]	51 [2.008]	M10	M33 x 2	1 Gas (BSPP)	1½-12UN-2B
	048	Outlet	27 [1.063]	51 [2.008]	M10	M33 x 2	1 Gas (BSPP)	1½-12UN-2B
		Inlet	27 [1.063]	51 [2.008]	M10	M33 x 2	1 Gas (BSPP)	1½-12UN-2B
	055	Outlet	27 [1.063]	51 [2.008]	M10	M33 x 2	1 Gas (BSPP)	1½-12UN-2B
		Inlet	27 [1.063]	51 [2.008]	M10	M33 x 2	1 Gas (BSPP)	1½-12UN-2B
	063	Outlet	36 [1.417]	62 [2.441]	M10	M42 x 2	1¼ Gas (BSPP)	1¾-12UN-2B
		Inlet	27 [1.063]	51 [2.008]	M10	M33 x 2	1 Gas (BSPP)	1½-12UN-2B
075	Outlet	36 [1.417]	62 [2.441]	M10	M42 x 2	1¼ Gas (BSPP)	1¾-12UN-2B	
	Inlet	27 [1.063]	51 [2.008]	M10	M33 x 2	1 Gas (BSPP)	1½-12UN-2B	
090	Outlet	36 [1.417]	62 [2.441]	M10	M42 x 2	1¼ Gas (BSPP)	1¾-12UN-2B	
	Inlet	27 [1.063]	51 [2.008]	M10	M33 x 2	1 Gas (BSPP)	1½-12UN-2B	

Anti-cavitation check valve • SNM3GN

SNM3GN

Turolia OCG offers an optional **integral anti-cavitation check valve** integrated in Group 3 motors bearing blocks. Available for all the displacements, the valve directs internally the flow from the motor outlet to the inlet, when the outlet pressure gets higher than the inlet one.

Valve schematic diagram

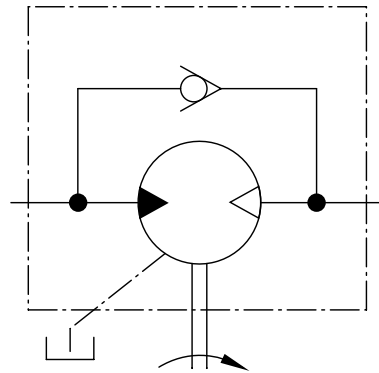

P005 261

Anticavitation check valve cross section

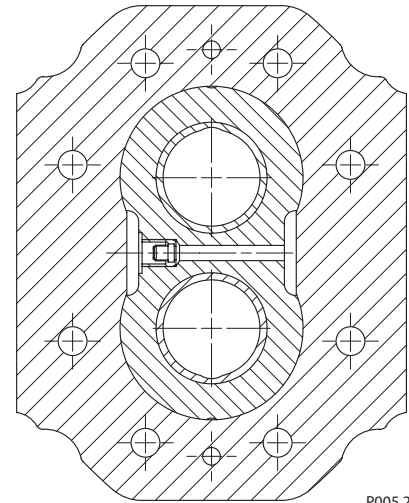

P005 275

SNM3NN, SNU3NN – 01FA, 01DA and 01BA

Standard porting drawing for 01FA, 01DA and 01BA

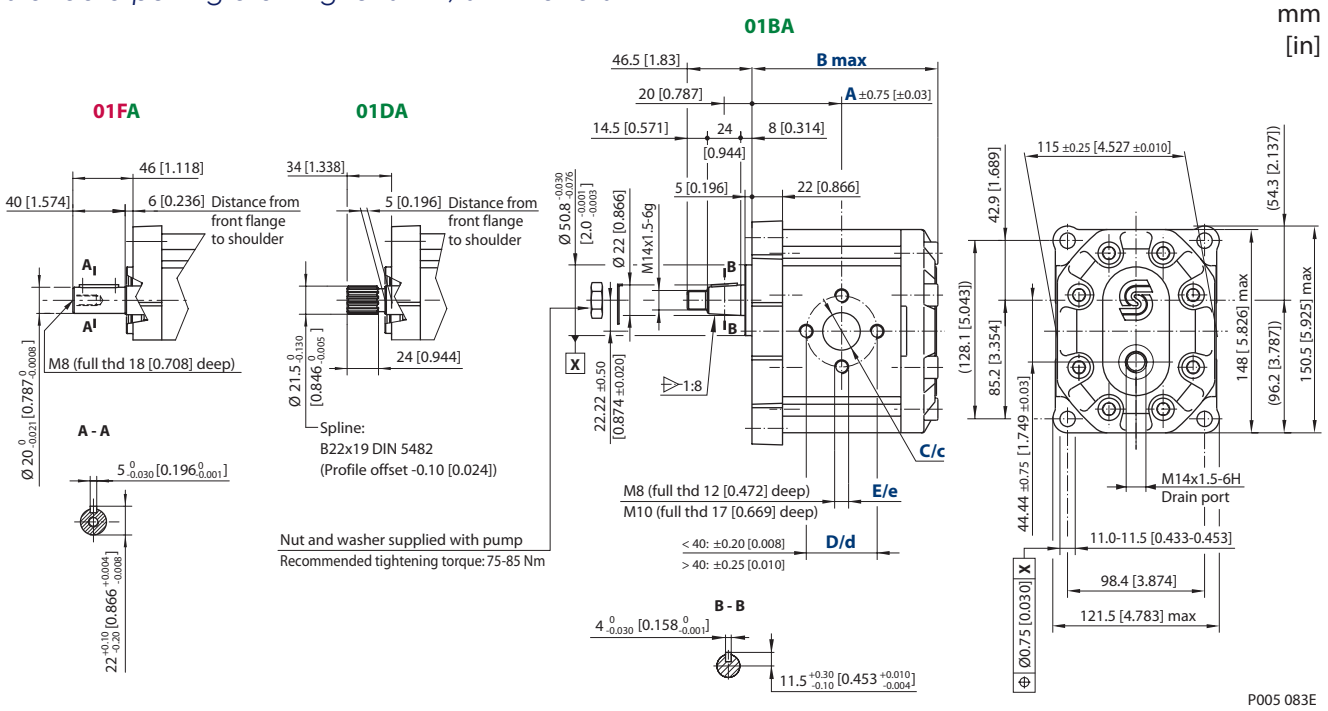

*Bidirectional motors dimensions – 01FA, 01DA and 01BA**

Frame size	022	026	033	038	044	048	055	063	075	090	
Dimension	A	63.0 [2.480]	64.5 [2.539]	67.0 [2.637]	68.8 [2.708]	71.0 [2.795]	72.5 [2.854]	75.0 [2.952]	78.0 [3.070]	82.0 [3.228]	87.0 [3.425]
	B	132.5 [5.216]	135.5 [5.334]	140.5 [5.531]	144.0 [5.669]	148.5 [5.846]	151.5 [5.964]	156.5 [6.161]	162.5 [6.397]	170.5 [6.712]	180.5 [7.106]
Inlet/Outlet	C/c	20 [0.79]				27 [1.063]					
	D/d	40 [1.58]				51 [2.007]					
	E/e	M8				M10					

* For unidirectional SNU3NN dimensions, see *SNU3NN ports*, pages 59 and 60.

For unidirectional motors no case drain hole into the rear cover.

Model code examples and maximum shaft torque

Flange/drive gear	Model code example	Maximum shaft torque
01FA	SNM3NN/075BN01FAM1CACANNNN/NNNNN	210 N•m [1858 lb•in]
01DA	SNM3NN/026BN01DAM1C7C7NNNN/NNNNN	290 N•m [2566 lb•in]
01BA	SNM3NN/044BN01BAM1CACANNNN/NNNNN	350 N•m [3097 lb•in]

For further details on ordering, see *Model Code*, pages 50 ÷ 52.

SNM3NN, SNU3NN – 02FA, 02DB and 02AA

Standard porting drawing for 02FA, 02DB and 02AA

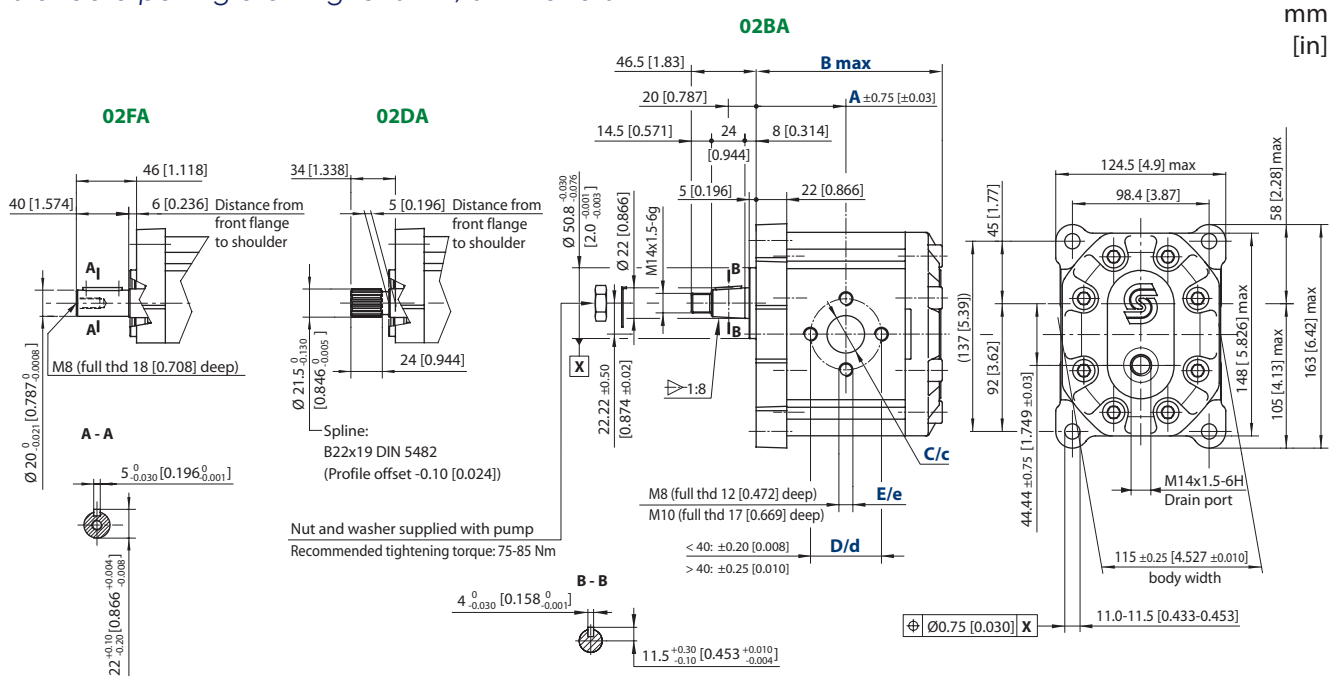

P005 084E

Bidirectional motors dimensions – 02FA, 02DA and 02BA*

Frame size		022	026	033	038	044	048	055	063	075	090
Dimension	A	63.0 [2.480]	64.5 [2.539]	67.0 [2.637]	68.8 [2.708]	71.0 [2.795]	72.5 [2.854]	75.0 [2.952]	78.0 [3.070]	82.0 [3.228]	87.0 [3.425]
	B	132.5 [5.216]	135.5 [5.334]	140.5 [5.531]	144.0 [5.669]	148.5 [5.846]	151.5 [5.964]	156.5 [6.161]	162.5 [6.397]	170.5 [6.712]	180.5 [7.106]
Inlet/Outlet	C/c	20 [0.79]		27 [1.063]							
	D/d	40 [1.58]		51 [2.007]							
	E/e	M8		M10							

* For unidirectional SNU3NN dimensions, see *SNU3NN ports*, pages 59 and 60.

For unidirectional motors no case drain hole into the rear cover.

Model code examples and maximum shaft torque

Flange/drive gear	Model code example	Maximum shaft torque
02FA	SNM3NN/044BN02FAM1CACANNNN/NNNNN	210 N•m [1858 lb•in]
02DA	SNM3NN/033BN02DAM1CACANNNN/NNNNN	290 N•m [2566 lb•in]
02BA	SNM3NN/026BN02BAM1C7C7NNNN/NNNNN	350 N•m [3097 lb•in]

For further details on ordering, see *Model Code*, pages 50 ÷ 52.

SNM3NN, SNU3NN – 03FB and 03BB

Standard porting drawing for 03FB and 03BB

mm
[in]

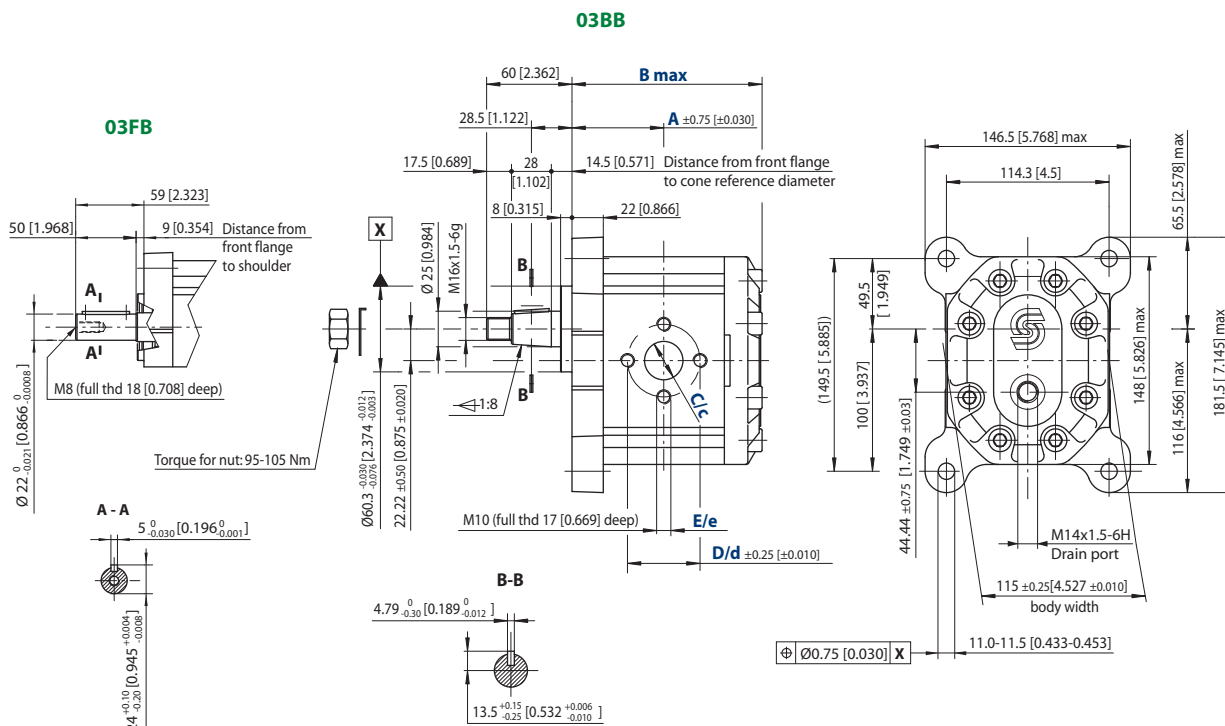

P005 085E

*Bidirectional motors dimensions – 03FB and 03BB**

Frame size		022	026	033	038	044	048	055	063	075	090
Dimension	A	61 [2.4]	63 [2.48]	64.5 [2.54]	66.5 [2.62]	69.5 [2.74]	72.5 [2.854]	75 [2.95]	78 [3.07]	82 [3.23]	87 [3.43]
	B	132.5 [5.22]	135.5 [5.33]	140.5 [5.53]	144.0 [5.67]	148.5 [5.85]	151.5 [5.96]	156.5 [6.16]	162.5 [6.4]	170.5 [6.71]	180.5 [7.11]
Inlet/Outlet	C/c	18 [0.71]			27 [1.063]						
	D/d	55 [2.16]									
	E/e	M8									

* For unidirectional SNU3NN dimensions, see *SNU3NN ports*, pages 59 and 60.

For unidirectional motors no case drain hole into the rear cover.

Model code examples and maximum shaft torque

Flange/drive gear	Model code example	Maximum shaft torque
03FB	SNM3NN/063BN03FBM1CACANNNN/NNNNN	300 N•m [2655 lb•in]
03BB	SNM3NN/090BN03BBM1CACANNNN/NNNNN	500 N•m [4425 lb•in]

For further details on ordering, see *Model Code*, pages 50 ÷ 52.

SNM3NN, SNU3NN – 06AA

Standard porting drawing for 06AA

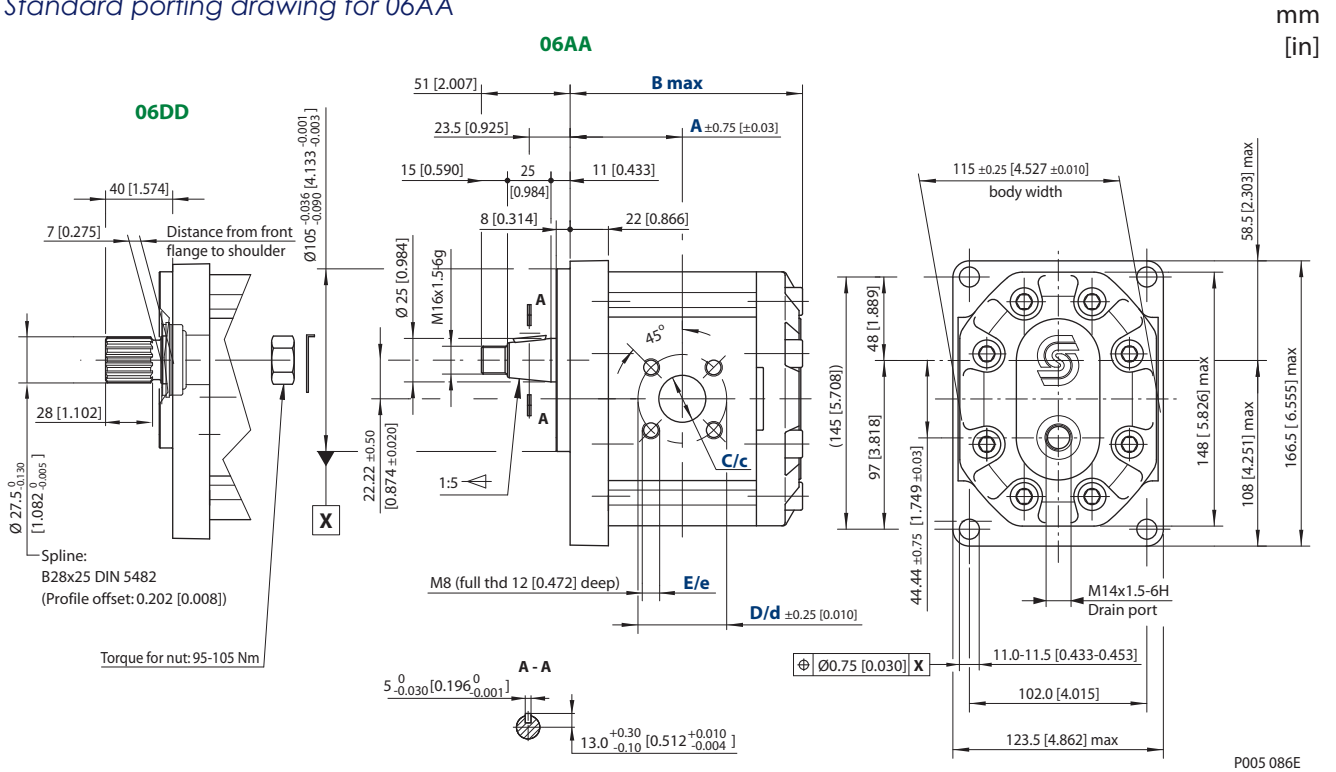

P005 086E

*Bidirectional motors dimensions – 06DD AND 06AA **

Frame size		022	026	033	038	044	048	055	063	075	090
Dimension	A	63.0 [2.480]	64.5 [2.539]	67.0 [2.637]	68.8 [2.708]	71.0 [2.795]	72.5 [2.854]	75.0 [2.952]	78.0 [3.070]	82.0 [3.228]	87.0 [3.425]
	B	132.5 [5.216]	135.5 [5.334]	140.5 [5.531]	144.0 [5.669]	148.5 [5.846]	151.5 [5.964]	156.5 [6.161]	162.5 [6.397]	170.5 [6.712]	180.5 [7.106]
Inlet/Outlet	C/c	20 [0.79]				27 [1.063]					
	D/d	40 [1.58]				51 [2.007]					
	E/e	M8				M10					

* For unidirectional SNU3NN dimensions, see *SNU3NN ports*, pages 59 and 60.

For unidirectional motors no case drain hole into the rear cover.

Model code examples and maximum shaft torque

Flange/drive gear	Model code example	Maximum shaft torque
06DD	SNM3NN/044BN06DDM1BBBBNNNN/NNNNN	300 N•m [2655 lb•in]
06AA	SNM3NN/022BN06AAM1BABANNNN/NNNNN	450 N•m [3982 lb•in]

For further details on ordering, see *Model Code*, pages 50 ÷ 52.

SNM3NN, SNU3NN – 07BC, 07SA and 07GA

Standard porting drawing for 07BC, 07SA and 07GA

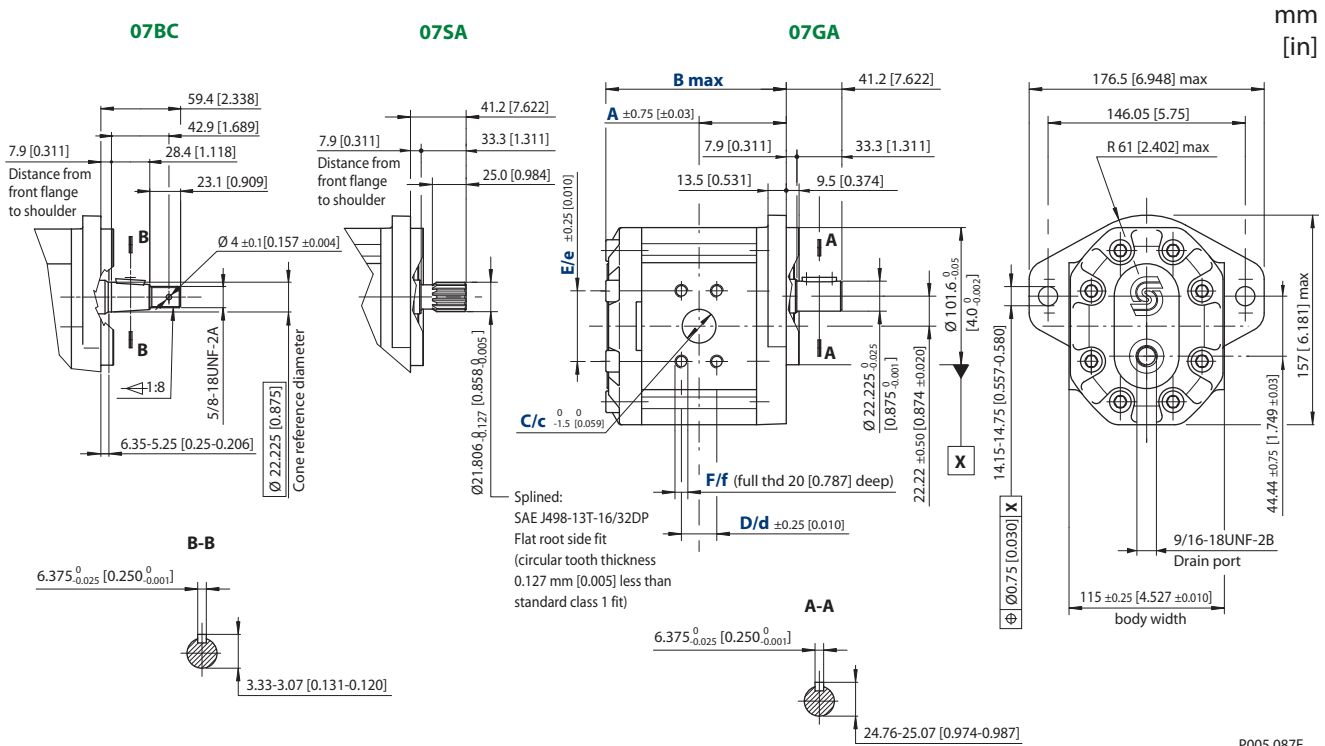

*Bidirectional motors dimensions – 07BC, 07SA and 07GA **

Frame size	022	026	033	038	044	048	055	063	075	090	
Dimension	A	63.0 [2.480]	64.5 [2.539]	67.0 [2.637]	68.8 [2.708]	71.0 [2.795]	72.5 [2.854]	75.0 [2.952]	78.0 [3.070]	82.0 [3.228]	87.0 [3.425]
	B	132.5 [5.216]	135.5 [5.334]	140.5 [5.531]	144.0 [5.669]	148.5 [5.846]	151.5 [5.964]	156.5 [6.161]	162.5 [6.397]	170.5 [6.712]	180.5 [7.106]
Inlet/Outlet	C/c	25.4 [1]			31.8 [1.251]						
	D/d	26.19 [1.031]			30.18 [1.188]						
	E/e	52.37 [2.061]			58.72 [2.311]						
	F/f	3/8-16UNC-2B			7/16-14UNC-2B						

* For unidirectional SNU3NN dimensions, see [SNU3NN ports](#), pages 59 and 60.

For unidirectional motors no case drain hole into the rear cover.

Model code examples and maximum shaft torque

Flange/drive gear	Model code example	Maximum shaft torque
07BC	SNM3NN/026BN07BCM6A3A3NNNN/NNNNN	300 N•m [2655 lb•in]
07SA	SNM3NN/063BN07SAM6A4A4NNNN/NNNNN	270 N•m [2389 lb•in]
07GA	SNM3NN/090BN07GAM6A4A4NNNN/NNNNN	230 N•m [2035 lb•in]

For further details on ordering, see [Model Code](#), pages 50 ÷ 52.

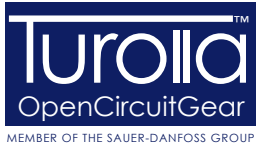

Gear Motors • Group 1, 2 and 3
Technical Information
Notes

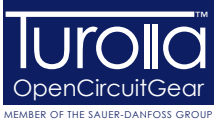

Our Products

Aluminum Gear Pumps

Aluminum Gear Motors

Cast Iron Gear Pumps

Cast Iron Gear Motors

Fan Drive Gear Motors Aluminum

Fan Drive Gear Motors Cast Iron

Turolla OpenCircuitGear™

Turolla OCG, with more than 60 years of experience in designing and manufacturing gear pumps, gear motors and fan drive motors of superior quality, is the ideal partner ensuring robustness and reliability to your work functions.

We are fast and responsive - the first to specify a customer product, the most experienced in providing technical knowledge and support for fan drive solutions.

We offer a lean value chain to our partners and customers and the shortest lead time in the market.

Turolla OCG is member of the Sauer-Danfoss Group.

Local address:

Turolla OpenCircuitGear

Via Villanova 28
40050 Villanova di Castenaso
Bologna, Italy
Phone: +39 051 6054411
Fax: +39 051 6053033

Turolla OpenCircuitGear

Kukučínova 2148-84
01701 Považská Bystrica, Slovakia
Phone: +421 424 301 544
Fax: +421 424 301 626

Turolla OpenCircuitGear

2800 East 13th Street
Ames, IA 50010
USA
Phone: +1 515 239 6000
Fax: +1 515 239 6618