

**Wörner**

# Stopping and positioning modules for automation technology

Product overview – 2019/20

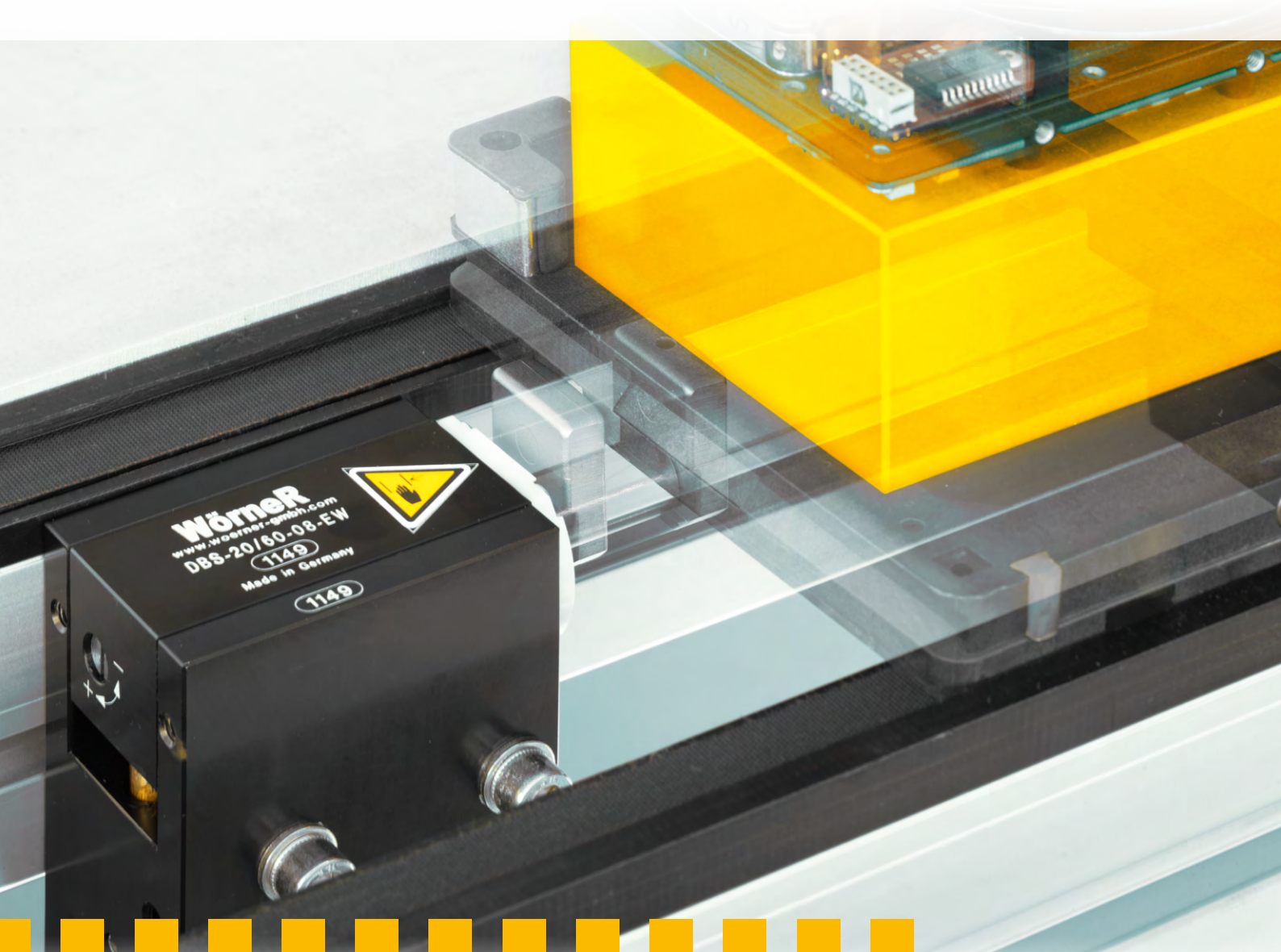

**Der Würner-Stopper. Das Original.**

**NEW**

# Electric stoppers for every requirement

**Wörner**

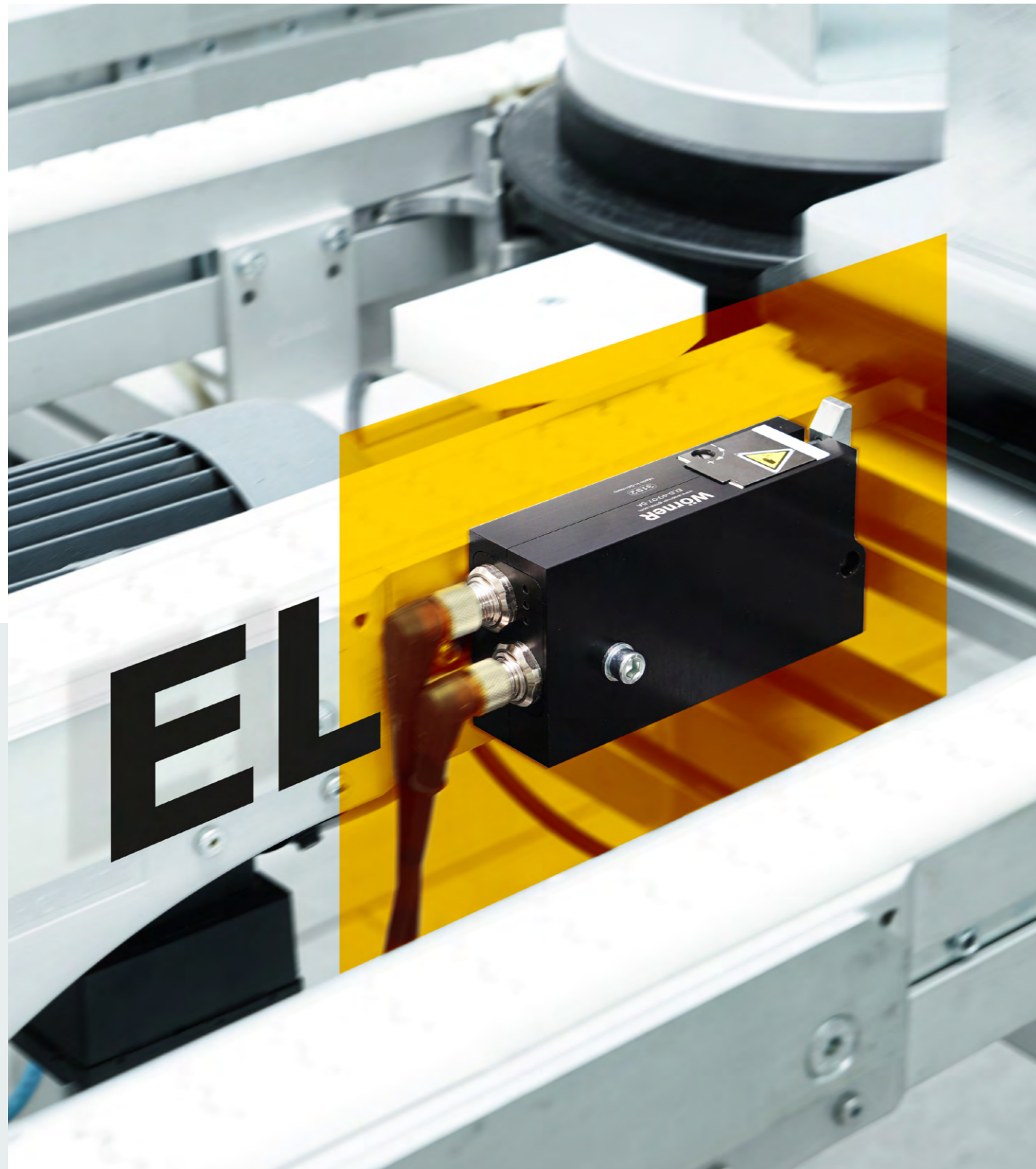

## Completely new product family: Electric stoppers with highest efficiency

Electrically driven stoppers provide numerous advantages:

- more than 70 % higher efficiency (compared to pneumatic systems)
- low operating costs
- minimal installation expenditure
- integrated sensors
- simple control of material flow
- low noise

Wörner electric stoppers are engineered to meet the requirements of a vast range of industries, with a proven track record in countless industrial automation applications.

Transport speed, pallet weight and robustness parameters determine the selection of the suitable Wörner component.

**EL** Information on the new stoppers of the EL line can be found on pages 21-23.

## Electric stoppers in a new variety



ELD-40

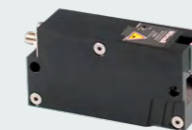

ELD-140



ELD-660



ELD-70



ELD-195



ELD-430



**NEW**

# An innovative product concept for maximum efficiency

**Wörner**



All-new designed:

## PN-Line pneumatic stoppers – Key features revisited for an innovative and economical solution

Through advanced technologies and focus on essential functions, the Wörner PN-Line achieves an excellent price/performance ratio.

With an increased scope of application and lower operating costs, you will protect your investments and enhance your competitiveness compared to conventional pneumatic stoppers.

- Patented technology
- Proven sturdiness and long life
- Increased damping capacity (+ 10 %)
- Reduced air consumption (- 10 %)

**PN** Information on the new stoppers of the PN line can be found on pages 13-15.

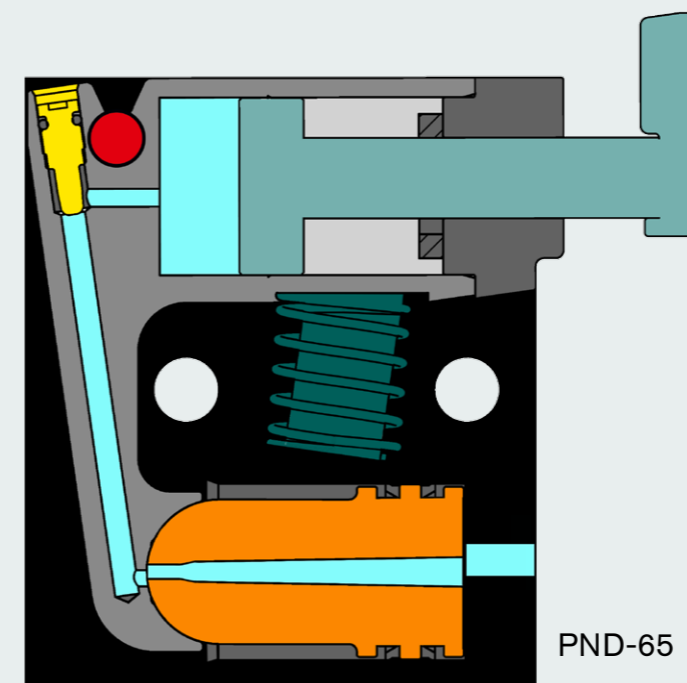

- Cutting-edge solution for air and lowering force transmission
- Optimal transmission of force into the basic housing (critical for residual stroke)
- Damping force easily adjustable from top of the stopper

**PN**

## Damping, stopping, positioning: The right solution for every requirement

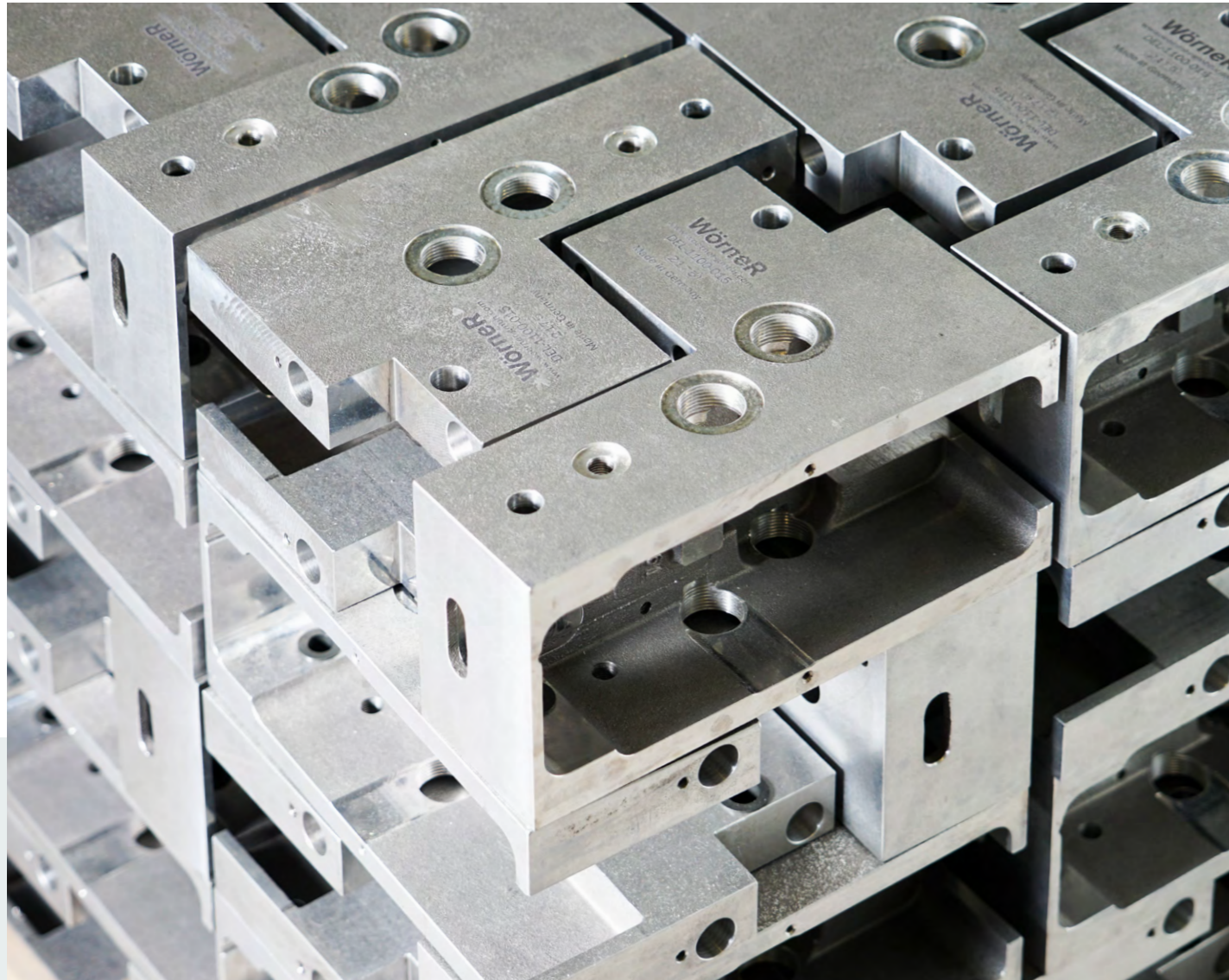

### ... to an international specialist for leading-edge stoppers

Wörner's product portfolio covers more than 2.500 components: stoppers, angle dampers, index cylinders and anti-bounce stops are successfully applied in all conventional assembly and conveyor systems in a large variety of industrial sectors.

Experience grown over decades, excellent industry know-how and a modern, highly specialized machine park guarantee that even unusual customer demands can be satisfied.

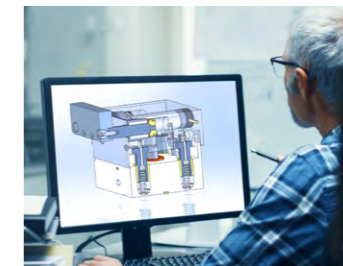

### From a simple workshop ...

The success story of our stoppers is based on the brilliant idea of the creative mind Helmut Wörner. The technology was patented in Germany 1990, from there the triumph takes its course: Within Europe and soon also internationally.

Today, Wörner stoppers are well-known around the globe. They are in fact a synonym for precision, durability and a safe investment.

*The first industrial stopper, the Wörner Delta „SDEH-5000“ (1986)*



### New, custom solutions through close collaboration

We welcome the chance to put our skills to the test with special tasks: The Wörner expert team generates solutions for any requirement – either from the existing product range of standard products or by designing a tailor-made solution in close cooperation with the customer.



## Uncompromising quality and performance

### Wörner products “Made in Germany” ...

Wörner has always been committed to an effective quality management system.

The entire Wörner staff is dedicated to achieve our most important goals: providing top performance for the highest quality of all products and services, achieving greatest customer satisfaction and ensuring competitiveness.

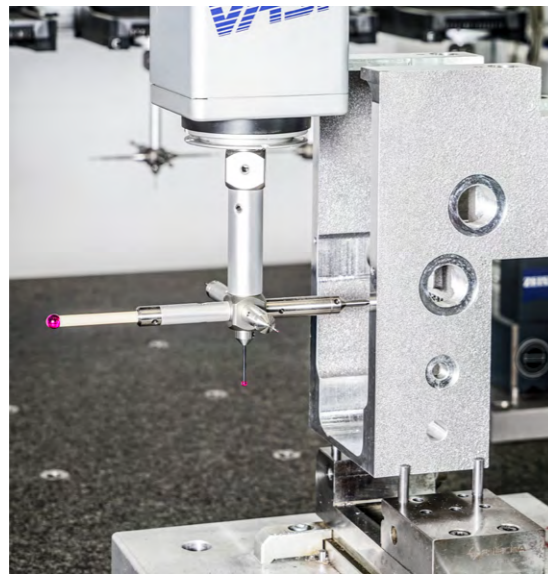

Component coordinate-measuring

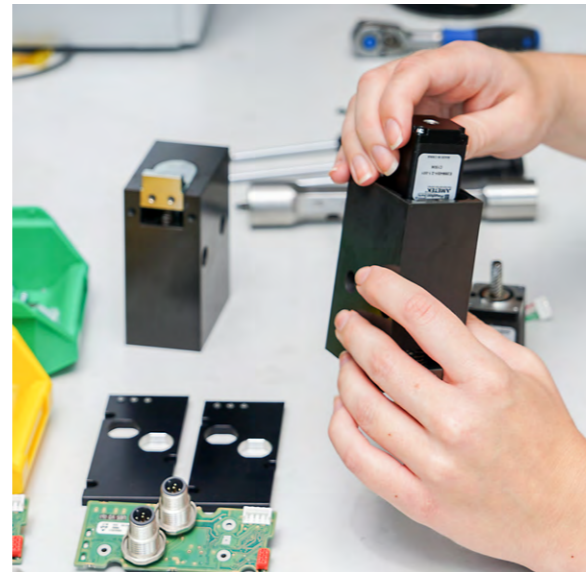

Electrical stopper assembly

### ... successfully applied all over the world

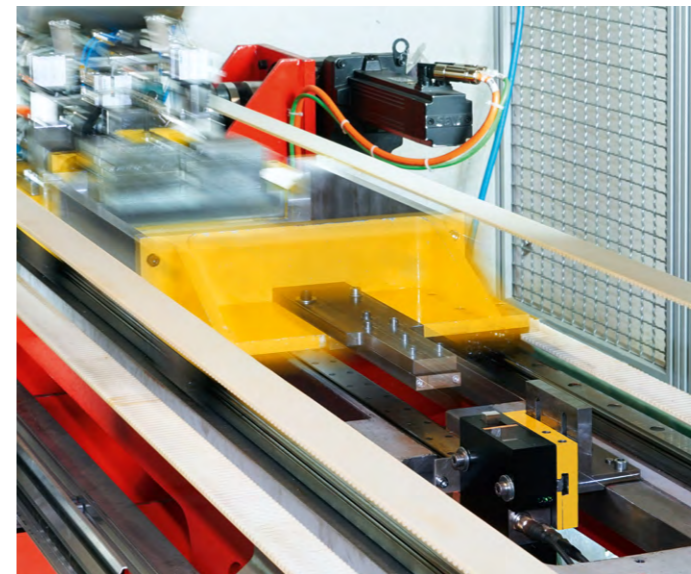

Endurance testing

Wörner's quality and environmental management systems are successfully certified in accordance to the international standards DIN ISO 9001 and ISO 14001. When developing new products, they have to pass extensive endurance tests.



Packaging and shipping

After assembly, every single unit goes through a final inspection.

Before any component leaves the factory, it is carefully packed. Through the international distribution network, Wörner products and services are available world wide.

### Wörner components for automated assembly, handling and manufacturing

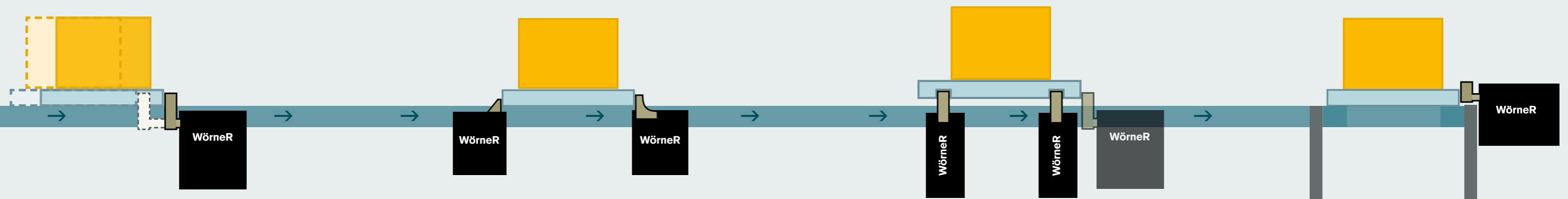

#### Damped stoppers

For shock-sensitive, fragile parts. Pallets are gently decelerated as they arrive so that workpieces reach their final position without rebound.

#### Anti-bounce stops

Anti-bounce stops hold the pallet loaded with individual parts in position with absolute precision to prevent any rebound.

#### Undamped stoppers

The tough, economical basic design. Suitable for use wherever one or more pallets are to be accumulated at a defined position.

#### Index cylinders

These guarantee precise vertical lifting of pallets and are ideal for rapid positioning tasks. The workpiece can be processed without vibration.

#### Angle dampers

Angle dampers are the preferred solution for changes of direction during the conveying of shock-sensitive or fragile parts.

■ Workpiece   
 ■ Pallet (for workpiece)   
 ■ Conveyor system (e.g. belt, chain, roller conveyor)

# Product overview



## The easy way to find the right product:

First of all, choose the **product family** and **product group**.

Then look for the corresponding **basic product** in the relevant table.

You can find the right **product variant** for your system using the data sheet associated with each basic product.

Please also refer to the technical explanations on pages 32/33.

The name of the product variant also serves as its order code (see notes on page 34).

If you need help identifying the variant you need, just get in touch with our service hotline:

Phone: +49 711 601 609 0  
E-mail: sales@woerner-gmbh.com

### A Wörner core competence:

## Custom solutions based on customer requirements

In addition to our proven standard products, we offer a variety of custom-built special solutions. You will find examples of these on the following pages under “**Custom-built ...**”.

Just contact us if your project involves special requirements and requires a specific solution!

### Product family

### Product group

Page

## Stoppers

Stopping and clearing

**Pneumatic undamped stoppers**

**D0 / PNU**

12

**Pneumatic damped stoppers**

**DBS / PND**

15

**Electric undamped stoppers**

**DEL0 / ELU**

20

**Electric damped stoppers**

**DEL / ELD**

21

**Pneumatic damped stoppers for roller systems**

**DBSR**

25

## Angle dampers

Stopping with change of direction

**Pneumatic/electric angle dampers**

**DBSQ / ELDQ**

26

## Index cylinders

Raising and positioning

**Pneumatic index cylinders**

**DI**

28

## Anti-bounce stops

Preventing rebound

**Pneumatic anti-bounce stops**

**DR**



29

## Accessories

Adapting products and extending their functionality

30

## Pneumatic undamped stoppers

Image	Basic product						Variants	Image	Basic product						Variants
	Lowering stroke	Damping stroke	max. propelling force*	Scope of application*		Weight			Lowering stroke	Damping stroke	max. propelling force*	Scope of application*		Weight	
	7 mm	n/a	48 N	06 m/min 09 12 18 24 30 36	70 kg 50 25 12 7 4 3		EW/DW H/K I/E cust.-spec. solutions var. access.		9 mm	n/a	270 N	06 m/min 09 12 18 24 30 36	390 kg 270 210 180 90 50 35	–	
	9 mm	n/a	82 N	06 m/min 09 12 18 24 30 36	120 kg 100 100 100 50 30 20		EW/DW H/K I/E cust.-spec. solutions var. access.		9 mm 15 mm 25 mm 40 mm	n/a	275 N	06 m/min 09 12 18 24 30 36	400 kg 300 250 200 110 65 50	EW/DW H/K E G/V cust.-spec. solutions var. access.	
	8 mm	n/a	96 N	06 m/min 09 12 18 24 30 36	140 kg 120 100 100 50 30 25		EW/DW H/K I cust.-spec. solutions var. access.		9 mm	n/a	275 N	06 m/min 09 12 18 24 30 36	400 kg 300 250 200 110 65 50	EW/DW rustproof cust.-spec. solutions var. access.	
	13 mm	n/a	206 N**	06 m/min 09 12 18 24	200 kg** 150** 120** 100** 60**		EW/DW E W50/W90 cust.-spec. solutions var. access.		20 mm	n/a	549 N	06 m/min 09 12 18 24 30 36	800 kg 800 800 800 450 250 250	EW/DW H/K I/E G cust.-spec. solutions var. access.	
	50 mm	n/a	206 N	06 m/min 09 12 18 24 30 36	300 kg 225 125 60 35 20 15		DW H/K cust.-spec. solutions var. access.		10 mm 20 mm	n/a	549 N	06 m/min 09 12 18 24 30 36	810 kg 810 810 810 450 250 250	EW/DW I/E G cust.-spec. solutions var. access.	

EW single-acting  
DW double-acting  
H heat-resistant  
K cold-resistant

I prepared for inductive position sensor  
E prepared for electronic position sensor





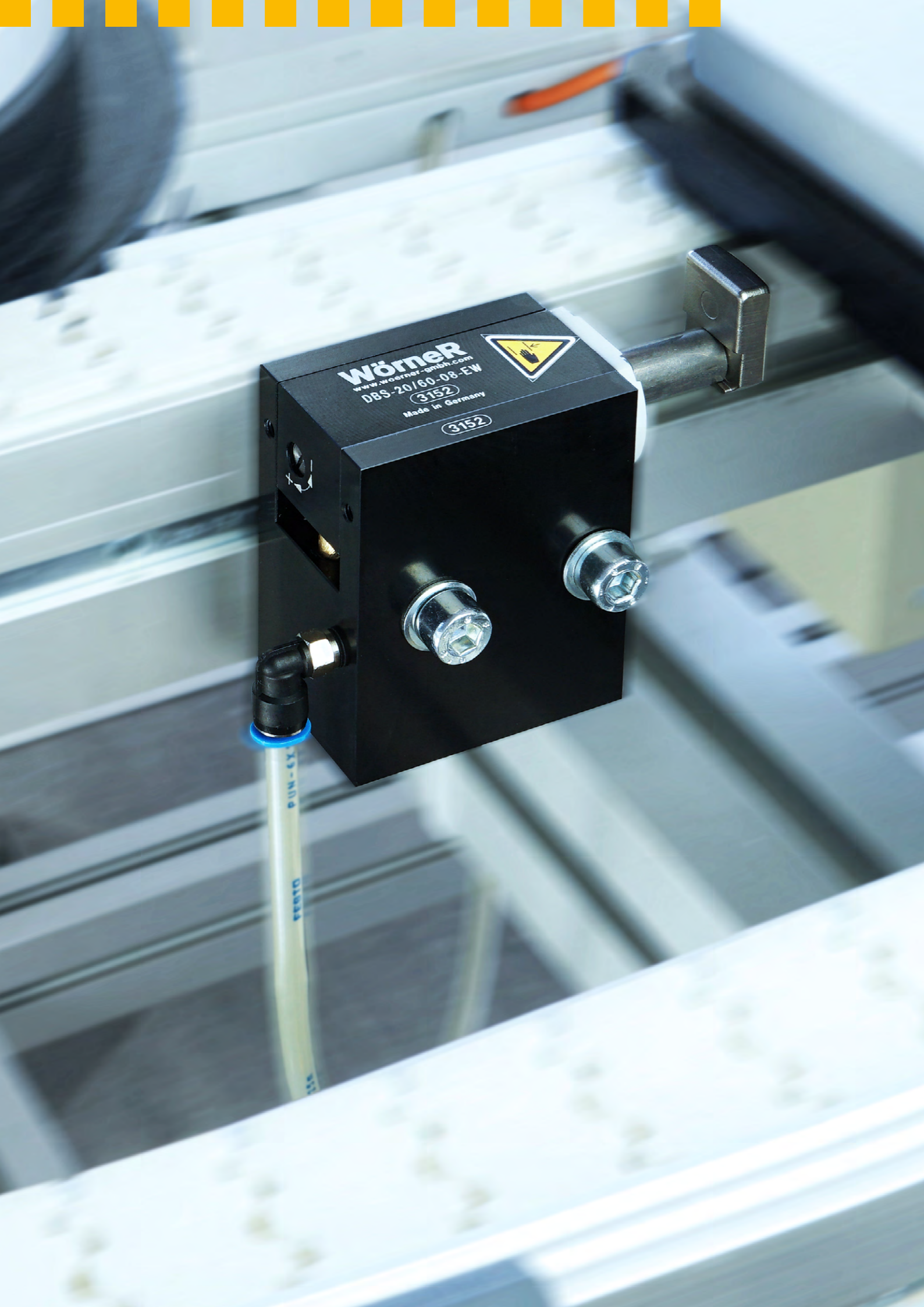

G stop plate with thread  
V extended stop plate  
W50 tilted stop plate 50°  
W90 tilted stop plate 90°

\* All specifications given for a coefficient of friction of  $\mu = 0.07$   
\*\* Scope of application highly depends on operating mode (EW/DW) and stop plate design (W50/W90), see data sheet

Note: The scope of application for undamped stoppers is highly dependent on the conditions of use, in particular on the coefficient of friction between the conveyor equipment and pallet and on the rigidity of the conveyor. We can provide you with detailed technical advice when making your choice - just ask us!

## Pneumatic damped stoppers



Basic product	Lowering stroke	Damping stroke	max. propelling force*	Scope of application*		Variants
				at	Weight	
 <b>DBS-18</b> 	7 mm	10 mm	15 N	06 m/min 09 12 18 24 30 36	0,25-22 kg 0,25-20 0,25-13 0,25-7 0,25-4 0,25-3 0,25-2	EW/DW H/K E KU cust.-spec. solutions var. access.
 <b>DBS-20/60</b> 	8 mm 13 mm	21.5 mm	41 N	06 m/min 09 12 18 24 30 36	3.5-60 kg 3.5-40 3.5-35 3.5-30 3.5-24 3.5-18 3.5-10	EW/DW H/K E KI/KU/KA/V S cust.-spec. var. access.
 <b>PND-65</b> 	8 mm	24 mm	45 N	06 m/min 09 12 18 24 30 36	3.5-65 kg 3.5-44 3.5-38 3.5-33 3.5-26 3.5-19 3.5-11	KI
 <b>DBS-140</b> 	8 mm	30 mm	103 N	06 m/min 09 12 18 24 30 36	5-150 kg 5-140 5-100 5- 80 5- 50 5- 40 5- 30	EW/DW H/K E cust.-spec. solutions var. access.
 <b>DBS-150</b> 	15 mm	20 mm	103 N	06 m/min 09 12 18 24 30 36	5-170 kg 5-140 5-100 5- 80 5- 50 5- 40 5- 25	EW/DW H/K KI cust.-spec. solutions var. access.

EW single-acting  
DW double-acting  
H heat-resistant  
K cold-resistant

E prepared for electronic position sensor  
KI tilt stop  
KU plastic stop

KA plastic stop antistatic  
V extended stop plate  
S prepared for stop position sensing

\* All specifications given for a coefficient of friction of  $\mu = 0.07$



## Pneumatic damped stoppers

Image	Basic product	Lowering stroke	Damping stroke	max. propelling force*	Scope of application*		Variants	Image	Basic product	Lowering stroke	Damping stroke	max. propelling force*	Scope of application*		Variants
					at	Weight							at	Weight	
	<b>DBS-170</b> 	8 mm	27.5 mm	200 N	06 m/min	5-200 kg	EW/DW H/K E KI/S19/S50 cust.-spec. solutions var. access.		<b>DBS-300</b> 	11 mm	24 mm	206 N	06 m/min	12-300 kg	EW/DW H/K S cust.-spec. solutions var. access.
	<b>DBS-150-T4</b> 	11.5 mm	20 mm	103 N	06 m/min	5-150 kg	EW/DW H/K cust.-spec. solutions var. access.		<b>DBS-410</b> 	15 mm	21 mm	700 N min.: 12 N	06 m/min	325 kg**	EW/DW KI/KU S cust.-spec. solutions var. access.
	<b>DBS-240</b> 	9 mm	24 mm	165 N	06 m/min	10-240 kg	EW/DW H/K KI/S20/S50/ S100 cust.-spec. solutions var. access.		<b>DBS-450</b> 	15 mm	40 mm	700 N min.: 12 N	06 m/min	610 kg**	EW/DW H KI/KU S cust.-spec. solutions var. access.
	<b>DBS-240-R</b> 	9 mm	24 mm	165 N	06 m/min	10-240 kg	EW/DW K rustproof cust.-spec. solutions var. access.		<b>DBS-1150</b> 	15 mm	21 mm	700 N min.: 30 N	09 m/min	700 kg**	EW/DW KI/KU S cust.-spec. solutions var. access.
	<b>DBS-255</b> 	9 mm	38 mm	186 N	06 m/min	1 - 270 kg	EW/DW H/K E S21/S35 cust.-spec. solutions var. access.		<b>DBS-2000</b> 	15 mm	25 mm	700 N min.: 130 N	06 m/min	2000 kg**	EW/DW KI/KU S cust.-spec. solutions var. access.

EW single-acting  
DW double-acting  
H heat-resistant  
K cold-resistant

E prepared for electronic position sensor  
KI tilt stop  
KU plastic stop

S prepared for stop position sensing

S19 steel stop, 19 mm wide  
S20 steel stop, 20 mm wide  
S21 steel stop, 21 mm wide

S35 steel stop, 35 mm wide  
S50 steel stop, 50 mm wide  
S100 steel stop, 100 mm wide

\* All specifications given for a coefficient of friction of  $\mu = 0.07$   
\*\* Exceptionally, these values apply at a coefficient of friction of  $\mu = 0.02$

## Pneumatic damped stoppers

Image	Basic product	Lowering stroke	Damping stroke	max. propelling force*	Scope of application*		Variants	Image	Basic product	Lowering stroke	Damping stroke	max. propelling force*	Scope of application*		Variants
					at	Weight							at	Weight	
	<b>DBS-3000</b> 	15 mm	46 mm	2060 N	09 m/min 12 18 24	110-3000 kg 110-3000 110-2350 110-1900	EW/DW S cust.-spec. solutions var. access.		<b>DBSST-35</b> 	7 mm	15.2 mm	29 N	06 m/min 09 12 18 24 30 36	1 - 42 kg 1 - 28 1 - 24 1 - 18 1 - 17 1 - 12 1 - 7	EW/DW H/K cust.-spec. solutions var. access.
	<b>DBSS06</b> 	8 mm	6 mm	7 N	06 m/min 09 12 18 24 30 36	0.7-10 kg 0.7- 5 0.7- 5 0.7- 4 0.7- 2.5 0.7- 1.5 0.7- 1	EW/DW H/K KI/KU/KA I cust.-spec. solutions var. access.		<b>DBSST-130</b> 	7 mm	18.3 mm	90 N	06 m/min 09 12 18 24 30 36	1 - 130 kg 1 - 90 1 - 77 1 - 60 1 - 40 1 - 38 1 - 20	EW/DW H/K cust.-spec. solutions var. access.
	<b>DBSS10</b> 	8 mm	10 mm	14 N	06 m/min 09 12 18 24 30 36	0.7-20 kg 0.7-10 0.7- 8 0.7- 6 0.7- 3.5 0.7- 2.5 0.7- 1.5	EW/DW H/K KI/KU/KA, I clean room ISO cl. 5 cust.-spec. var. access.		<b>DBSU-150</b> 	9 mm	22 mm	103 N	06 m/min 09 12 18 24 30 36	5-150 kg 5-100 5-100 5- 90 5- 55 5- 35 5- 25	EW/DW H/K KI cust.-spec. solutions var. access.
	<b>DBSSI-20</b> 	8 mm	14 mm	14 N	06 m/min 09 12 18 24 30 36	1-20 kg 1-15 1-12 1-10 1- 6 1- 4 1- 2.5	EW/DW H/K I cust.-spec. solutions var. access.		<b>DBSU-270</b> 	9 mm	25.5 mm	185 N	06 m/min 09 12 18 24 30 36	10-270 kg 10-220 10-200 10-180 10-110 10- 70 10- 50	EW/DW H/K KI cust.-spec. solutions var. access.

### Custom-built:

#### DBS-1100-15-EW-011



With integrated anti-bounce stop designed to keep the pallet in position after the damping operation. A sealed cover that travels simultaneously with the damping unit protects the device against dirt and aggressive liquids. The solution also includes a retracted stop sensor (damping completed but mechanism still locked) and makes it possible to lock the stop in the lower position. Ideally suited for use in harsh environments, e.g. when linking machining centers in the automotive industry.

EW single-acting  
DW double-acting  
H heat-resistant  
K cold-resistant

I prepared for inductive position sensor  
KI tilt stop  
KU plastic stop  
KA plastic stop antistatic

S prepared for stop position sensing

\* All specifications given for a coefficient of friction of  $\mu = 0.07$











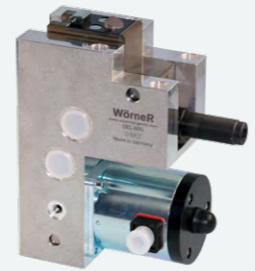
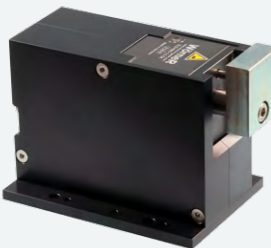

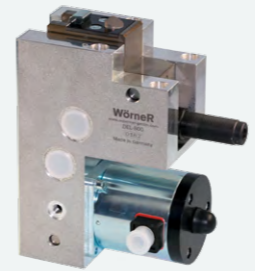

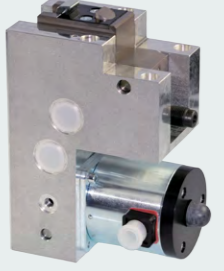

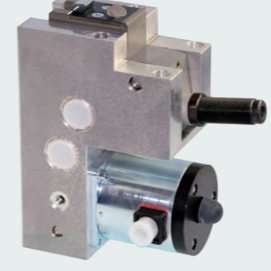

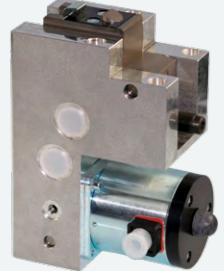
## Electric undamped stoppers / Rotary Switch

Image	Basic product	Lowering stroke	Damping stroke	max. propelling force*	Scope of application*		Variants	Image	Basic product	Lowering stroke	Damping stroke	max. propelling force**	Scope of application**		Variants
					at	Weight							at	Weight	
	<b>DELO-65</b> 	9 mm	n/a	65 N	06 m/min 09 60 12 55 18 50	65 kg	KU R cust.-spec. solutions var. access.	 	<b>ELD-40</b> 	7,5 mm	10 mm	45 N	06 m/min 09 0,25 - 30 12 0,25 - 20 18 0,25 - 11 24 0,25 - 10 30 0,25 - 8 36 0,25 - 5	0,25 - 40 kg 0,25 - 30 0,25 - 20 0,25 - 11 0,25 - 10 0,25 - 8 0,25 - 5	2x5-pin M12x1 plug KU cust.-spec. solutions var. access.
	<b>DELO-120</b> 	14 mm	n/a	206 N	06 m/min 09 140 12 80 18 35 24 20 30 13 36 9	300 kg	2x5-pin M12x1 plug, R cust.-spec. solutions var. access.	 	<b>ELD-70</b> 	8 mm	13 mm	60 N	06 m/min 09 3,5 - 45 12 3,5 - 40 18 3,5 - 29 24 3,5 - 15 30 3,5 - 10 36 3,5 - 7	3,5 - 70 kg 3,5 - 45 3,5 - 40 3,5 - 29 3,5 - 15 3,5 - 10 3,5 - 7	2x5-pin M12x1 plug KU cust.-spec. solutions var. access.
	<b>ELU-20</b> 	7 mm	n/a	20 N	06 m/min 09 12 12 7 18 3	20 kg	KI cust.-spec. solutions var. access.	 	<b>ELD-140</b> 	8 mm	15 mm	100 N	06 m/min 09 2 - 120 12 2 - 75 18 2 - 45 24 2 - 26 30 2 - 17 36 2 - 12	2 - 140 kg 2 - 120 2 - 75 2 - 45 2 - 26 2 - 17 2 - 12	2x5-pin M12x1 plug KU cust.-spec. solutions var. access.
	<b>ELU-30</b> 	7 mm	n/a	35 N	06 m/min 09 15 12 9 18 4	30 kg	KI cust.-spec. solutions var. access.	 	<b>ELD-195</b> 	8 mm	20 mm	200 N	06 m/min 09 3,5 -195 12 3,5 -170 18 3,5 -150 24 3,5 - 80 30 3,5 - 50 36 3,5 - 25	3,5 -195 kg 3,5 -170 3,5 -150 3,5 - 80 3,5 - 50 3,5 - 25	2x5-pin M12x1 plug KU cust.-spec. solutions var. access.
	<b>DELW</b> Rotary Switch 	n/a	n/a	n/a	n/a	n/a	2x5-pin M12x1 plug cust.-spec. solutions var. access.	 	<b>ELD-430</b> 	11 mm	25 mm	420 N	06 m/min 09 5 - 430 12 5 - 340 18 5 - 280 24 5 - 180 30 5 - 90 36 5 - 50	5 - 430 kg 5 - 340 5 - 280 5 - 180 5 - 120 5 - 90 5 - 50	2x5-pin M12x1 plug KU cust.-spec. solutions var. access.

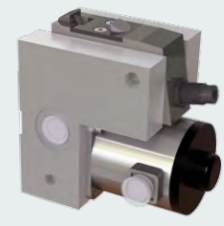
KI tilt stop  
 KU plastic stop  
 R with spring reset

\* All specifications given for a coefficient of friction of  $\mu = 0.07$

## Electric damped stoppers

EL 	Basic product	Lowering stroke	Damping stroke	max. propelling force*	Scope of application*		Variants		Basic product	Lowering stroke	Damping stroke	max. propelling force*	Scope of application*		Variants
					at	Weight							at	Weight	
	<b>ELD-660</b> 	11 mm	20 mm	450 N	06 m/min 09 12 18 24 30 36	660 kg 600 450 250 130 90 60	2x5-pin M12x1 plug KU cust.-spec. solutions var. access.		<b>DEL-800</b> 	9 mm	20 mm	419 N**	06 m/min 09 12 18 24 30	950 kg** 850** 750** 600** 450** 300**	cust.-spec. solutions var. access.
	<b>DEL-235</b> 	9.3 mm	16.1 mm	419 N** min.: 25 N**	06 m/min 09 12 18 24 30	250 kg** 190** 180** 135** 110** 55**	cust.-spec. solutions var. access.		<b>DEL-1100</b> 	9.3 mm	20.2 mm	419 N** min.: 65 N**	06 m/min 09 12 18 24	1100 kg** 1000** 850** 650** 370**	cust.-spec. solutions var. access.
	<b>DEL-400</b> 	9 mm	16 mm	419 N**	06 m/min 09 12 18 24 30	400 kg** 340** 330** 255** 190** 150**	cust.-spec. solutions var. access.		<b>DEL-350-S2</b> 	8 mm	21 mm	240 N	06 m/min 09 12	80-350 kg 80-300 80-250	cust.-spec. solutions var. access.
	<b>DEL-630</b> 	8 mm	16 mm	250 N**	06 m/min 09 12 18 24 30	45 - 650 kg** 45 - 610** 45 - 450** 45 - 300** 45 - 190** 45 - 140**	cust.-spec. solutions var. access.		<b>ELD-1200</b> 	20 mm	25 mm	750 N**	m/min 06 09 12 18	kg 500-1350** 500-1350** 500-1200** 500- 700**	3x5-pin M12x1 plug, cust.-spec. solutions var. access.
	<b>DEL-650</b> 	9.3 mm	16.1 mm	419 N** min.: 30 N	06 m/min 09 12 18 24 30	650 kg** 610** 450** 300** 200** 140**	cust.-spec. solutions var. access.								

KU plastic stop

\* All specifications given for a coefficient of friction of  $\mu = 0.07$

\*\* Exceptionally, these values apply at a coefficient of friction of  $\mu = 0.02$







## Pneumatic damped stoppers for roller systems



### Custom-built:

#### DBSR-400-15-EW-004

The unit possesses an integrated anti-bounce stop designed to keep the pallet in position after the damping operation. It is also pre-assembled with pre-adjusted clamping holders designed for the installation of inductive sensors to determine the stop positions.

Basic product	Lowering stroke	Damping stroke	max. propelling force*	Scope of application*		Variants
				at	Weight	
 <b>DBSR-30</b> 	8 mm	5.8 mm	21 N	06 m/min 09 12 18	5-30 kg 5-25 5-12 5- 8	EW/DW cust.-spec. solutions var. access.
 <b>DBSR-270</b> 	15 mm	17 mm	185 N	06 m/min 09 12 18 24 30 36	15-270 kg 15-230 15-150 15- 60 15- 30 15- 25 15- 20	EW/DW S cust.-spec. solutions var. access.
 <b>DBSR-400</b> 	15 mm 25 mm	22 mm	275 N	06 m/min 09 12 18 24 30 36	15-400 kg 15-360 15-280 15-130 15- 90 15- 60 15- 40	EW/DW cust.-spec. solutions var. access.
 <b>DBSR-550</b> 	15 mm 25 mm**	28 mm	378 N	06 m/min 09 12 18 24 30	18-550 kg 18-470 18-350 18-190 18-120 18- 85	EW cust.-spec. solutions var. access.
 <b>DBSR-1000</b> 	15 mm	21 mm	618 N	09 m/min 12 18 24 30	60-900 kg 60-750 60-550 60-250 60-180	EW/DW cust.-spec. solutions var. access.

EW single-acting  
DW double-acting  
S prepared for stop position sensing

\* All specifications given for a coefficient of friction of  $\mu = 0.07$   
\*\* Version with slightly restricted damping capacity

## Pneumatic/ electric angle dampers

Basic product	Lowering stroke	Damping stroke	max. propelling force*	Scope of application*		Variants	Image	Basic product	Lowering stroke	Damping stroke	max. propelling force*	Scope of application*		Variants
				at	Weight							at	Weight	
 	n/a	7 mm	n/a	06 m/min	0.25-15 kg	H/K W/G cust.-spec. solutions var. access.		DBSQ-270	n/a	24 mm	n/a	06 m/min	10-270 kg	H/K cust.-spec. solutions var. access.
 	n/a	21.5 mm	n/a	06 m/min	1-60 kg	H/K W/KU/KA cust.-spec. solutions var. access.		DBSQ-300	n/a	14,7 mm	n/a	06 m/min	10-300 kg	H/K cust.-spec. solutions var. access.
 	n/a	23 mm	n/a	06 m/min	1 - 65 kg	W cust.-spec. solutions var. access.		DBSQ-400	n/a	23 mm	n/a	06 m/min	7-400 kg	H/K cust.-spec. solutions var. access.
 	n/a	29 mm	n/a	06 m/min	5-220 kg	cust.-spec. solutions var. access.		DBSQ-1100	n/a	21 mm	n/a	09 m/min	40-1100 kg	H/K cust.-spec. solutions var. access.
 	n/a	24 mm	n/a	06 m/min	5-150 kg	H/K cust.-spec. solutions var. access.		ELDQ-300	n/a	14,7 mm	n/a	06 m/min	10 - 300 kg	W cust.-spec. solutions var. access.

- H heat-resistant
- K cold-resistant
- KU plastic stop
- KA plastic stop antistatic
- W angle stop
- G straight stop

\* All specifications given for a coefficient of friction of  $\mu = 0.07$

### Custom-built:





**3842545128**





This unit is equipped with a special stop.



## Index cylinders

## Anti-bounce stops

	Basic product	Stroke	Force	max. lateral force	Variants
	<b>DI-490</b> 	31 mm	490 N	170 N	H I/E cust.-spec. solutions var. access.
	<b>DI-1050</b> 	31,5 mm	1050 N	170 N	H cust.-spec. solutions var. access.
	<b>DI-2200-25-001</b> 	25 mm	2200 N	240 N	Special variant

	Basic product	Stroke	Variants
	<b>DR</b> 	8 mm	cust.-spec. solutions var. access.
	<b>DRP</b> 	8 mm	I/E cust.-spec. solutions var. access.

H heat-resistant  
I prepared for inductive position sensor  
E prepared for electronic position sensor

### Custom-built:

#### DI-1050-15-007

This unit was designed as a round construction in contrast to our usual index cylinders. It is also equipped with an integrated cover.



### Custom-built:

#### DRP-001

This unit possesses a different housing geometry: increased height, recesses at the side, and threaded holes at the bottom of the case to permit fastening from below.



## Accessories

### Product-specific accessories

We offer an extensive range of accessories to accompany our products. For details, please refer to the relevant data sheets.

By way of example, the accessories illustrated here are for the pneumatically driven, damped stopper DBS-20/60:

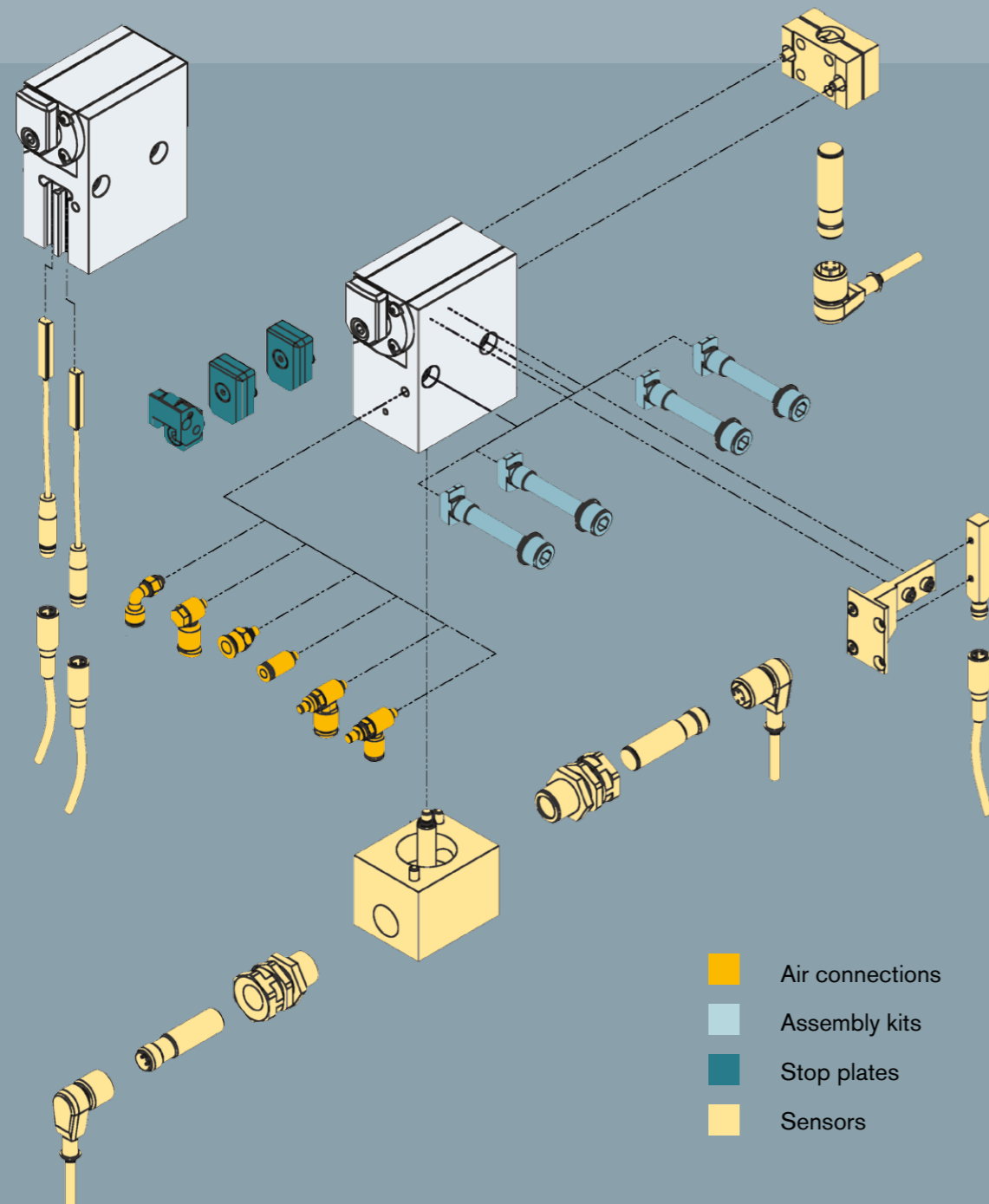

### Product-independent accessories

#### Position sensor for pallet

**DP**



**Basic product**

AU / AS  
cust.-spec.  
solutions

#### Sensor bracket

**DSA**



H/K  
cust.-spec.  
solutions

- H heat-resistant
- K cold-resistant
- AU bottom-mounted sensor
- AS side-mounted sensor



## Technical explanations

### Basic function: Lowering

#### Propelling force $F_R$

The propelling force  $F_R$  is the friction force between the conveyor equipment and the pallet. It is a function of the coefficient of friction  $\mu$ , the weight of the pallet  $m$  and acceleration due to gravity  $g$ :

$$F_R = \mu \cdot m \cdot g$$

If more than one pallet has been accumulated than the number of pallets  $n$  must also be considered:

$$F_R = n \cdot \mu \cdot m \cdot g$$

The coefficient of friction  $\mu$  is a function of the friction between the conveyor equipment and the pallet.

#### Examples for the coefficient of friction:

Belt/band:  $\mu = 0.2$  to  $0.3$   
 Plastic modular belt:  $\mu = 0.3$  to  $0.5$   
 Accumulation roller chain:  $\mu = 0.01$  to  $0.03$

#### Example calculation:

$m_{\text{workpiece}} = 5 \text{ kg}$   
 $m_{\text{pallet}} = 2 \text{ kg}$   
 $\mu = 0.2$   
 $g = 9.81 \text{ m/s}^2$   
 $F_R = (5 + 2) \text{ kg} \cdot 0.2 \cdot 9.81 \text{ m/s}^2 = 13.7 \text{ N}$

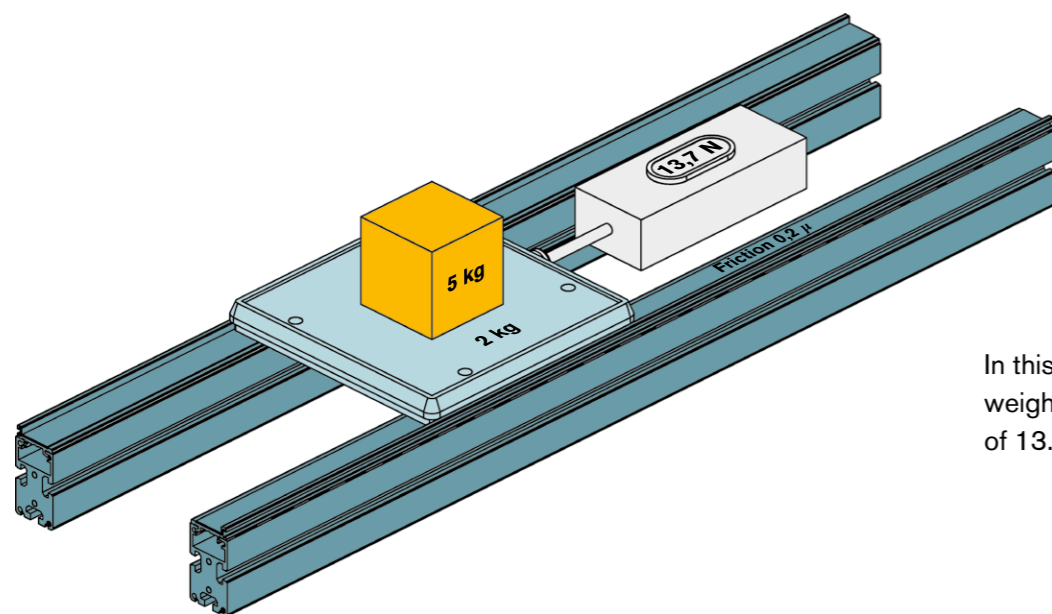

In this example, a pallet of total weight 7 kg exerts a propelling force of 13.7 N on a double belt conveyor.

The product brochure and data sheets indicate the maximum propelling force against which the stopper can reliably lower during long-term operation. The propelling force in your system must be less than the specified value.

#### Example for DBS-20/60:

(Value given for coefficient of friction  $\mu = 0.07$ ):  
 Maximum propelling force 41 N

Please note that other pallet weights can be reliably lowered at different coefficients of friction. Using the formula above, you can easily convert the maximum propelling force specified by us for other coefficients of friction.

We would be happy to advise you – just contact us!

### Basic function: Stopping

#### Deceleration force $F_v$

(by way of example for damped stopper)

The deceleration force  $F_v$  is required to slow the pallet down to a halt and dissipate the kinetic energy stored in the pallet. It consists of the damping force (at conveyor speed  $v$  and damping stroke  $s$ ) and the propelling force, which continues to have an effect even during the damping operation:

$$F_v = \frac{m \cdot v^2}{2s} + m \cdot g \cdot \mu$$

The scope of application of the various stoppers is indicated in the product brochure and data sheets. Using these tables, it is easy to determine whether the intended stopper is able to damp the expected pallet weight at your required conveyor speed.

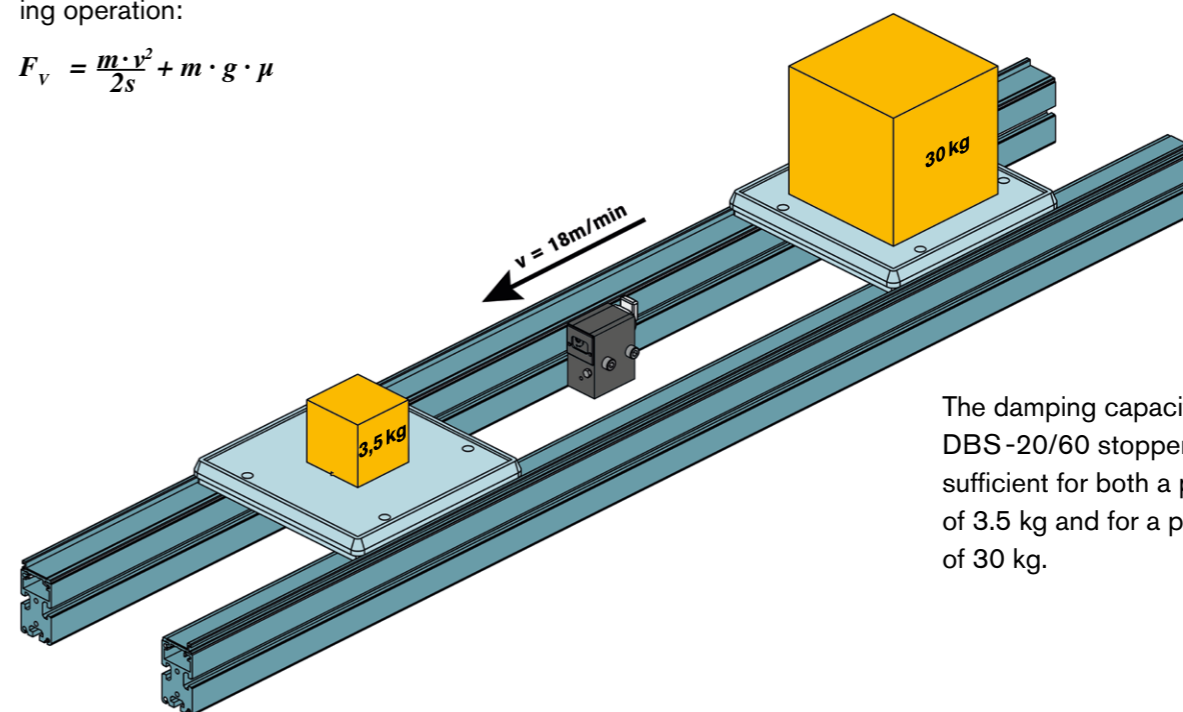

The damping capacity, e.g. of a DBS-20/60 stopper at 18m/min, is sufficient for both a pallet with a weight of 3.5 kg and for a pallet with a weight of 30 kg.

#### Example for DBS-20/60

(Values given for coefficient of friction  $\mu = 0.07$ ):

Conveyor speed	Pallet weight
6 m/min	3.5 - 60 kg
9 m/min	3.5 - 40 kg
12 m/min	3.5 - 35 kg
18 m/min	3.5 - 30 kg
24 m/min	3.5 - 24 kg
30 m/min	3.5 - 18 kg
36 m/min	3.5 - 10 kg

Please note that other combinations of the conveyor speed and pallet weight parameters are possible, or may indeed be required, at different coefficients of friction. This is true, in particular, when the propelling force accounts for a high proportion of the deceleration force, i.e. in systems with high levels of friction.

You can obtain an initial approximation of these values using the formula above.

We would be happy to advise you – just contact us!

## Overview of the Wörner product system

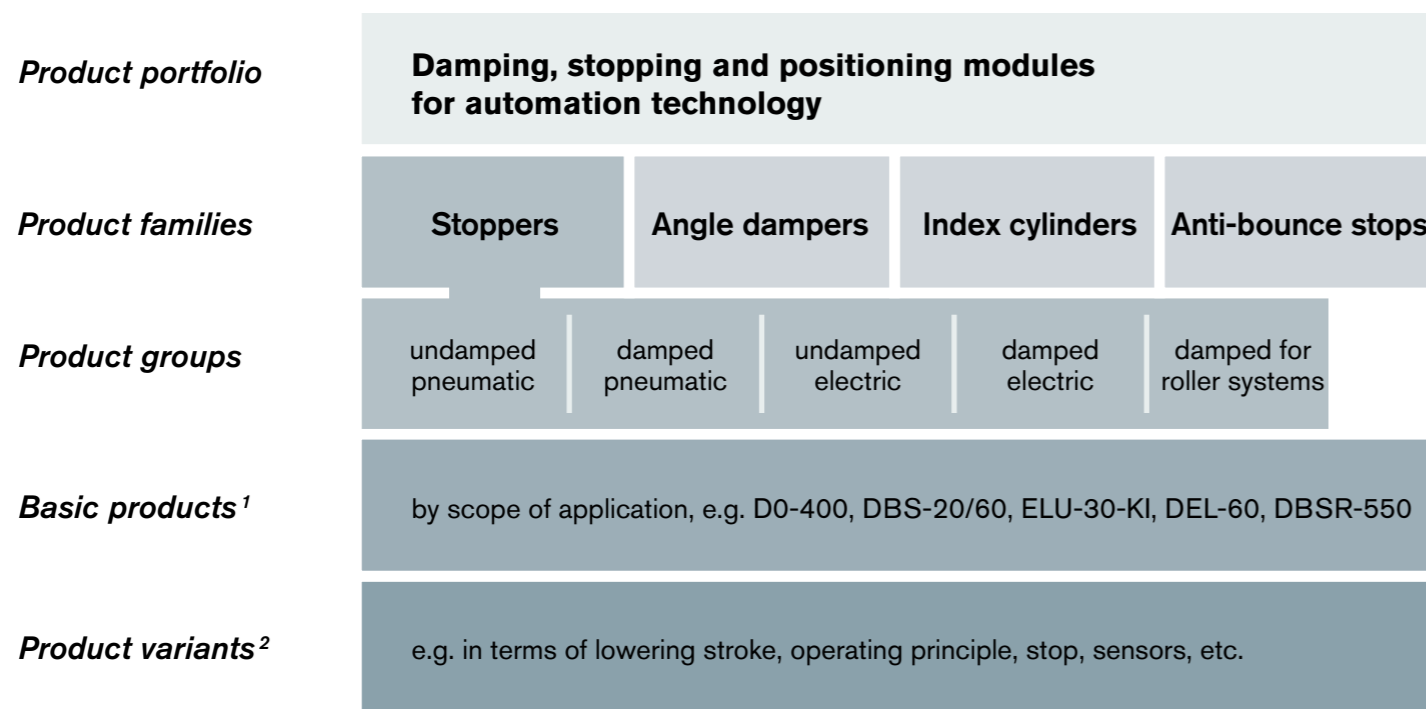

<sup>1</sup> The basic products differ in their scope of application, primarily in terms of the maximum pallet weight that can be stopped.

<sup>2</sup> The product variants – i.e. the products that can be ordered – are determined by selecting the required technical characteristics, for example in terms of lowering stroke, function, temperature range or stop design.

### Order code

You can identify the product variant that is right for your application by consulting the relevant basic product data sheet.

You can choose between the variants defined there, for example on the basis of the lowering stroke, function, temperature range or stop design.

We would be delighted to assist you in choosing your product variant or by developing a custom product tailor-made for your application.

The example opposite illustrates the composition of the order code for a pneumatically driven, damped stopper of type DBS-20/60.

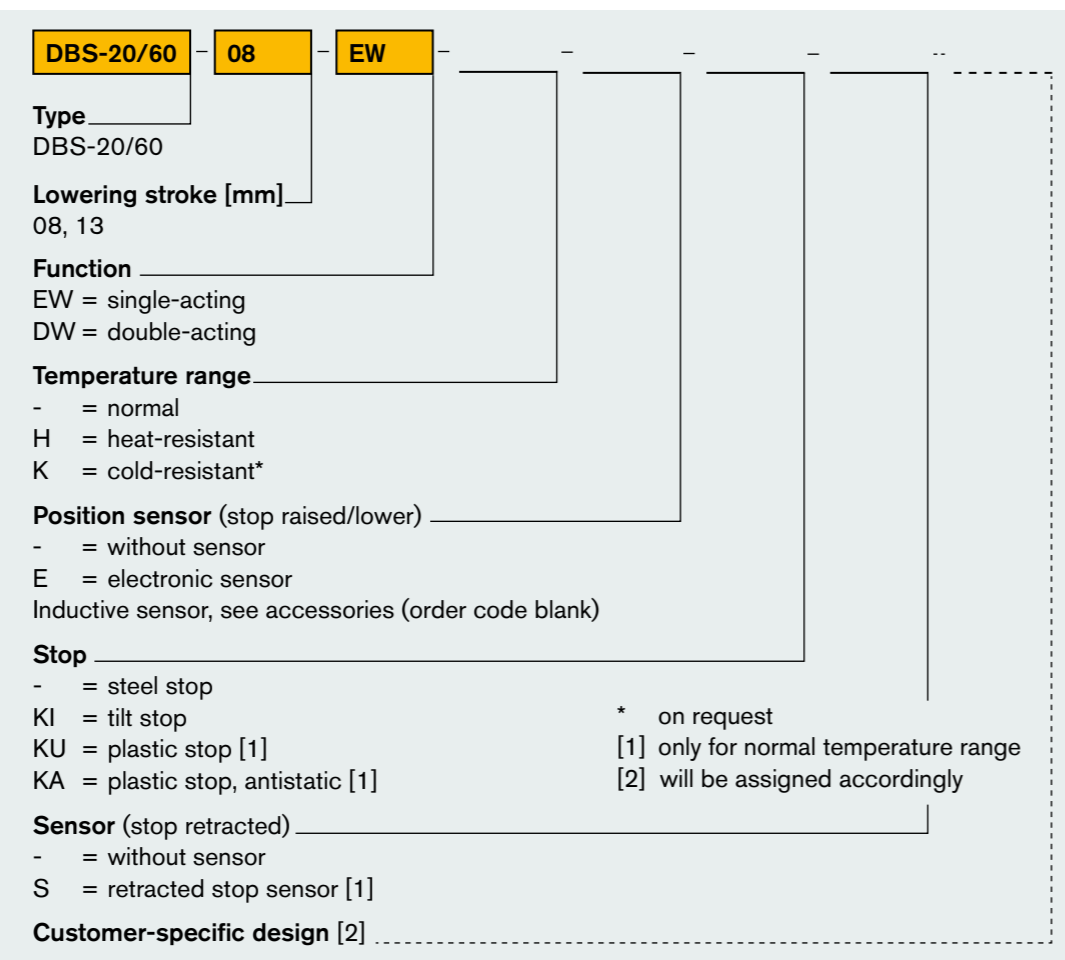

## Glossary

### Lowering stroke

Distance travelled by the stop to clear and lock (lower or raise) the pallet.

### Stop

Component that stops the pallet. Available in a number of designs (plastic stop, steel stop, tilt stop, various dimensions). The combination of pallet and stop materials is an important factor determining the achievable lowering force.

### Basic product

Similar basic products form a product group. Basic products differ in their scope of application, usually in terms of the maximum pallet weight they can stop.

### Order code

The order code reflects the composition of a product variant and uniquely identifies this. It is possible to order directly from Wörner using this code.

### Operating pressure

Working pressure of the pneumatic system. Specifications in data sheets (for the lowering force, for example) usually refer to a operating pressure of 6 bar.

### Damping stroke

Distance travelled by the stop when decelerating the pallet. The length of the damping stroke is important for the stopper's damping capacity.

### Double-acting

Both the lowering and raising of the stop (into the locking position) are pneumatically or electrically driven movements. Benefits: Closed pneumatic system, higher lowering forces because no spring force has to be overcome.

### Angle damper

For stopping with change of direction. Preferred solution for changes of direction during the conveying of shock-sensitive or fragile parts.

### Scope of application

Identifies a stopper's damping capacity. Table specifying the maximum pallet weight that can be stopped at different conveyor speeds.

### Single-acting

Lowering is a pneumatically or electrically driven movement. By contrast, the stop is raised into the locking position by spring force. Benefits: Easier to control because, for example, only one pneumatic connection is needed. When no compressed air is supplied, the stopper always moves to the locked position (safety feature).

### Electronic sensor

Electronic, non-contact sensor system for the detection of certain stop positions.

### Conveyor speed

Speed at which the pallet is transported.

### Index cylinder

For raising and positioning. Guarantees precise positioning and vertical lifting of the pallet and is ideal for rapid positioning tasks. The workpiece can be processed without vibration.

### Inductive sensor

Inductive, non-contact sensor system for the detection of certain stop positions.

### Air consumption

A unit's compressed air consumption expressed in litres per work cycle, usually at a working pressure of 6 bar.

### Pallet weight

Weight of the pallet and/or the workpiece.

### Position sensor

Accessory available for many stopper models. Can be used to determine the position of the stop. For full functionality, further accessories are required (proximity switch, for example).

### Product variant

Variant derived from a basic product (for example in terms of lowering stroke, function, temperature range or stop design). The name of the product variant corresponds to the order code that can be used to order the unit from Wörner.

### Friction

Force required to set a stationary body in motion or to continue to move a moving body in a constant way. Is a function of the coefficient of friction and weight of the body.

### Coefficient of friction

Designates the friction between the conveyor equipment and pallet. Important for the design of the stopping point because both the damping and the lowering capacity depend on the friction.

### Anti-bounce stop

For preventing rebound. Holds the pallet loaded with individual parts in position with absolute precision to prevent any rebound. Used in particular in combination with undamped stoppers.

### Stopper, undamped

For stopping and clearing pallets. Tough, economical basic design. Suitable for use wherever one or more pallets are to be accumulated at a defined position.

### Stopper, damped

For stopping and clearing pallets. For shock-sensitive, fragile parts. Pallets are gently decelerated as they arrive so that workpieces reach their final position without rebound. The forces transferred to the conveyor system are considerably reduced.

### Deceleration force

Required to slow the pallet down to a halt and dissipate the kinetic energy stored in the pallet. It consists of the damping force and the propelling force, which continues to have an effect even during the damping operation.

### Propelling force

Friction force between the conveyor equipment and pallet. Is a function of the coefficient of friction, pallet weight and acceleration due to gravity.

## Wörner worldwide

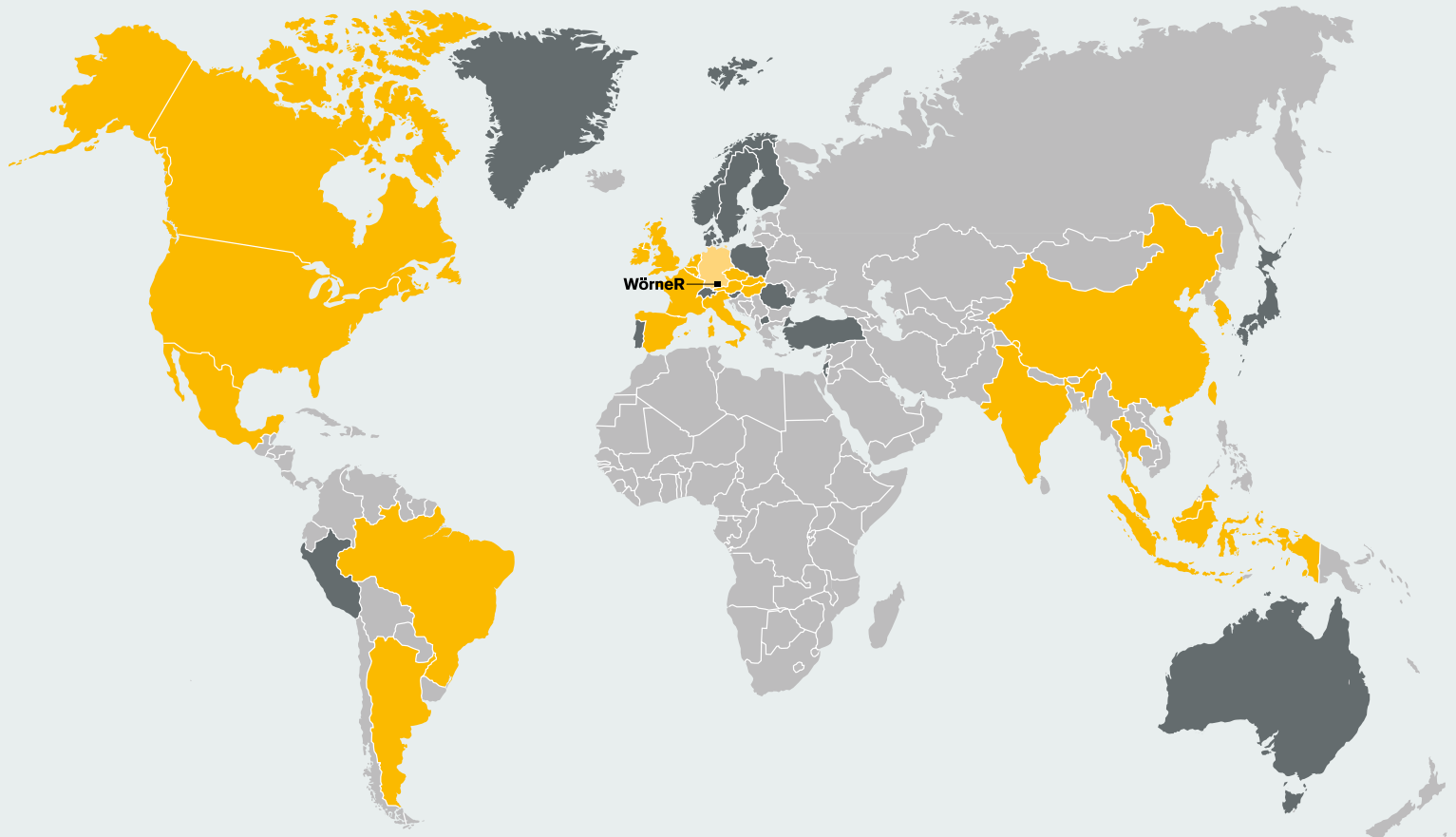

- Countries with regional sales offices or partners
- Countries with well-established customer relationships

Contact details of our international sales partners are available on our website: [www.woerner-gmbh.com](http://www.woerner-gmbh.com)

## Contact us for more

We are committed to exceptional service and support.

If you should have any questions related to products, orders or shipments, or if you should require personal advice, simply contact our headquarter in Denkendorf. We will put you in touch with a representative who understands your needs.

### Wörner Automatisierungstechnik GmbH

Rechbergstraße 50  
73770 Denkendorf  
Germany

Tel. +49 711 601 609-0  
Fax +49 711 601 609-10

[sales@woerner-gmbh.com](mailto:sales@woerner-gmbh.com)  
[www.woerner-gmbh.com](http://www.woerner-gmbh.com)