

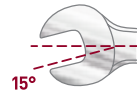

75
19 mm
3/4"

72

60
8-9 mm
3/16-5/16"

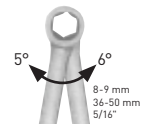

CLICKRAFT

DOUBLE RATCHET



COMBINATION

XXL LARGO



XXL LARGO 90



DOUBLE RING



REVERSIBLE



QUAD REVERSIBLE

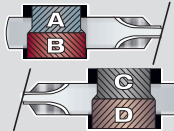

FLEX



STUBBY FLEX

DOUBLE FLEX



ANGLE

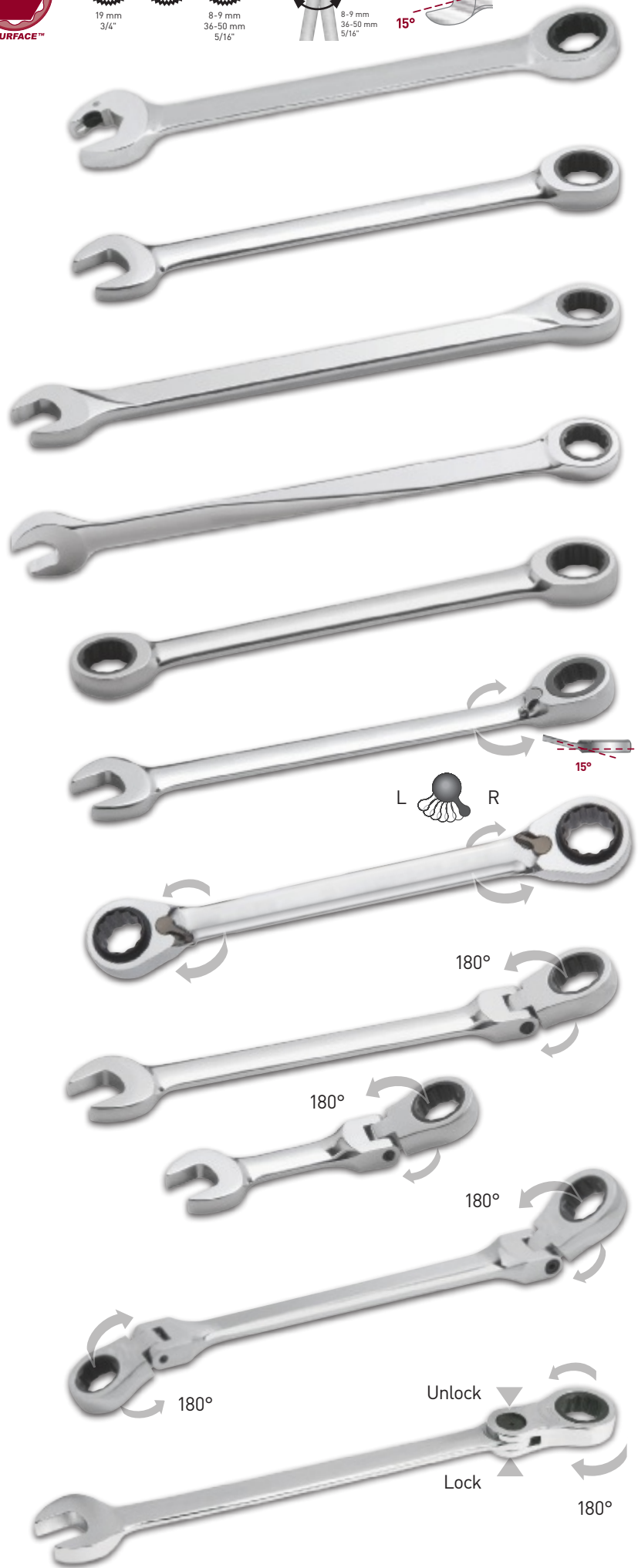

DOUBLE RATCHET CLICKRAFT

Double ratchet combination wrench

flat, with additional ratcheting function in the open end

Llave combinada doble carraca

plana, con mecanismo adicional efecto carraca en la boca abierta

Chave boca-luneta com roquete duplo

direita, com mecanismo de roquete adicional na boca

Art.	Ø mm	D mm	L mm	Ø
3401-08	8	17.7	140	60
3401-09	9	19.0	149	60
3401-10	10	21.1	159	72
3401-11	11	23.1	165	72
3401-12	12	24.5	172	72
3401-13	13	26.5	178	72
3401-14	14	27.9	190	72
3401-15	15	30.5	199	72
3401-16	16	32.4	208	72
3401-17	17	34.2	225	72
3401-18	18	35.3	236	72
3401-19	19	36.1	248	75
3401-20	20	42.3	270	72
3401-21	21	42.3	270	72
3401-22	22	42.3	291	72
3401-24	24	49.3	312	72

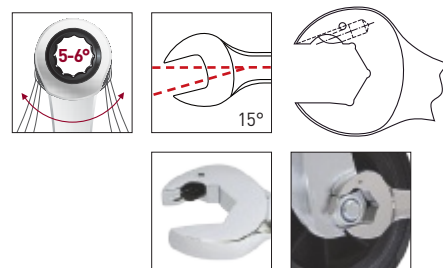

Double ratchet combination wrench set

flat, with additional ratcheting function in the open end

Juego de llaves combinadas doble carraca

planas, con mecanismo adicional efecto carraca en la boca abierta

Jogo de chaves boca-luneta com roquete duplo

direitas, com mecanismo de roquete adicional na boca

Art.	Ø mm
3401-50	10-13-17-19

4
PCS



Double ratchet combination wrench set

flat, with additional ratcheting function in the open end

Juego de llaves combinadas doble carraca

planas, con mecanismo adicional efecto carraca en la boca abierta

Jogo de chaves boca-luneta com roquete duplo

direitas, com mecanismo de roquete adicional na boca

Art.	mm
3401-54	8-9-10-11-12-13-14-15-16-17-18-19



Double ratchet combination wrench case

flat, with additional ratcheting function in the open end (except 5.5-6-7 mm)

Estuche de llaves combinadas doble carraca

planas, con mecanismo adicional efecto carraca en la boca abierta (excepto 5.5-6-7 mm)

Jogo de chaves boca-luneta com roquete duplo em mala

direitas, com mecanismo de roquete adicional na boca (exceto 5.5-6-7 mm)

*Option / Opcionales / Opção

- Art. 3691  1/4" x  10 mm
- Art. 3692  3/8" x  13 mm
- Art. 3693  1/2" x  19 mm
- Art. 2694  1/4" x  10 mm

Art.	mm
4900-40K	5.5-6-7-8-9-10-11-12-13-14-15-16-17-18-19



COMBINATION CLICKRAFT

Ratchet combination wrench

flat

Llave combinada carraca

plana

Chave boca-luneta com roquete

direita

Art.	Ø mm	D mm	L mm	Ø
3405	5.5	16.5	125	60
3406	6	17.0	125	60
3407	7	17.0	140	60
3408	8	17.0	140	60
3409	9	18.5	149	60
3410	10	20.5	160	72
3411	11	21.5	165	72
3412	12	23.0	170	72
3413	13	25.0	180	72
3414	14	28.0	190	72
3415	15	29.0	200	72
3416	16	30.0	210	72
3417	17	31.5	225	72
3418	18	33.0	235	72
3419	19	34.0	250	75
3420	20	41.0	290	72
3421	21	41.0	290	72
3422	22	41.5	290	72
3424	24	48.0	333	72
3427M	27	52.5	360	72
3430M	30	59.0	400	72
3432M	32	62.5	425	72
3434M	34	63.0	460	72
3436M	36	64.0	500	60
3441M	41	68.0	575	60
3446M	46	76.0	645	60
3450M	50	80.0	655	60

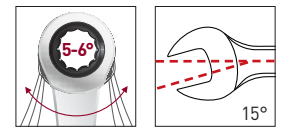
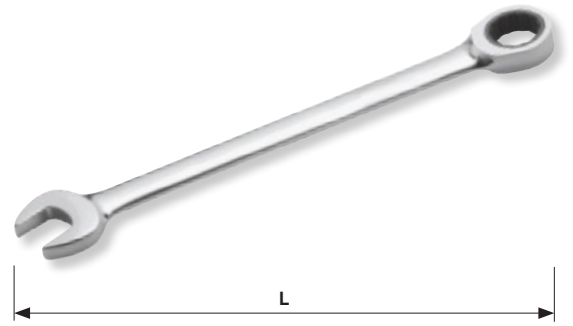

Ratchet combination wrench set

flat

Juego de llaves combinadas carraca

planas

Jogo de chaves boca-luneta com roquete

direitas

Art.	mm
3400-50	10-13-17-19

4
PCS



Ratchet combination wrench set

flat

Juego de llaves combinadas carraca

planas

Jogo de chaves boca-luneta com roquete

direitas

Art.	mm
3427	8-10-12-13-17-19

6
PCS



Ratchet combination wrench case

flat

Juego de llaves combinadas carraca

planas

Jogo de chaves boca-luneta com roquete

direitas

Art.	mm
3400-54	8-9-10-11-12-13-14-15-16-17-18-19

12
PCS



↕ 325 x 185 x 56 mm

COMBINATION CLICKRAFT

COMPLETO

19
PCS



421 x 200 x 68 mm

Ratchet combination wrench case

flat, with socket- and bit-adapters

Estuche de llaves combinadas carraca

planas, con adaptadores para llaves de vaso y puntas

Jogo de chaves boca-luneta com roquete em mala

direitas, com adaptadores para chaves de caixa e bits

* inklusiv / inclus / incluso



Art. 3691 1/4" x 10 mm

Art. 3692 3/8" x 13 mm

Art. 3693 1/2" x 19 mm



Art. 2694 1/4" x 10 mm



Art.	mm
4900-17K	5.5-6-7-8-9-10-11-12-13-14-15-16-17-18-19

Ratchet combination wrench, inch

flat

Llave combinada carraca pulgada

plana

Chave boca-luneta com roquete, polegada

direita

inch

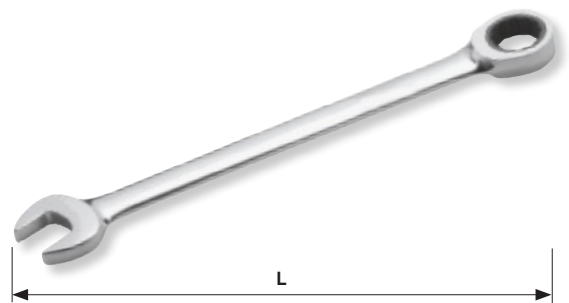

L

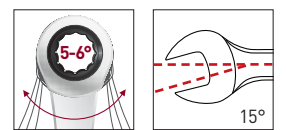

Art.	inch	D mm	L mm	mm
3431	5/16"	17.0	140	60
3432	3/8"	20.5	160	72
3433	7/16"	21.2	165	72
3434	1/2"	25.5	180	72
3435	9/16"	28.0	190	72
3436	5/8"	30.0	210	72
3437	11/16"	31.5	225	72
3438	3/4"	34.0	250	75

Ratchet combination wrench set, inch

flat

Juego de llaves combinadas carraca en pulgadas

planas

Jogo de chaves boca-luneta com roquete, polegada

direitas

8
PCS

inch



Art.	inch
3430	5/16"-3/8"-7/16"-1/2"-9/16"-5/8"-11/16"-3/4"

Ratchet combination wrench

flat, extra long

Llave combinada carraca

plana, extra larga

Chave boca-luneta com roquete

direita, extra longa



Art.	mm	D mm	L mm	mm
4402-08	8	17.5	150	60
4402-09	9	18.3	165	60
4402-11	11	22.3	195	72
4402-12	12	24.0	207	72
4402-14	14	28.2	235	72
4402-15	15	30.2	250	72
4402-16	16	32.0	260	72
4402-17	17	32.8	275	72
4402-18	18	33.6	290	72
4402-19	19	36.4	305	75
4402-20	20	41.2	318	72
4402-21	21	41.2	318	72
4402-22	22	41.2	330	72
4402-24	24	46.7	356	72

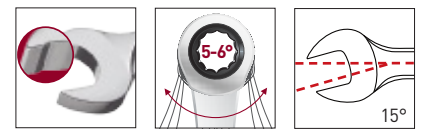

LARGO



STANDARD

LARGO

+22%

STANDARD



XXL

Ratchet combination wrench set

flat, extra long

Juego de llaves combinadas carraca

planas, extra largas

Jogo de chaves boca-luneta com roquete

direitas, extra longas

*Option / Opcionales / Opção



Art. 3691 1/4" x 10 mm

Art. 3692 3/8" x 13 mm

Art. 3693 1/2" x 19 mm



Art. 2694 1/4" x 10 mm



Art.	mm
4402-51	8-10-13-17-19

5
PCS



380 x 212 x 55 mm

Ratchet combination wrench set

flat, extra long

Juego de llaves combinadas carraca

planas, extra largas

Jogo de chaves boca-luneta com roquete

direitas, extra longas

*Option / Opcionales / Opção



Art. 3691 1/4" x 10 mm

Art. 3692 3/8" x 13 mm

Art. 3693 1/2" x 19 mm



Art. 2694 1/4" x 10 mm



Art.	mm
4402-52	8-10-11-12-13-16-17-18-19

9
PCS



380 x 212 x 55 mm

Ratchet combination wrench set

flat, extra long

Juego de llaves combinadas carraca

planas, extra largas

Jogo de chaves boca-luneta com roquete

direitas, extra longas

*Option / Opcionales / Opção



Art. 3691 1/4" x 10 mm

Art. 3692 3/8" x 13 mm

Art. 3693 1/2" x 19 mm



Art. 2694 1/4" x 10 mm



Art.	mm
4402-53	8-9-10-11-12-13-14-15-16-17-18-19

12
PCS



380 x 212 x 55 mm

LARGO 90 combination ratchet wrench

500 % more contact and press area grace to the 90° crossbeam forge of the LARGO 90-wrench. Open and ring end sided working without tender spots in your hands since you work with the handle surface and not with the thin handle edge.

Llave combinada con carraca LARGO 90

500 % de mayor contacto y area de presión gracias a su torsión a 90° de la nueva serie LARGO. La presión se realiza sobre una superficie plana en vez de sobre los bordes rectos de la llave permitiendo trabajar con una máxima ergonomía para la palma de la mano.

Chave boca-luneta com roquete LARGO 90

500 % mais área de contacto e força graças aos 90° da nova chave LARGO 90. A pressão exercida na parte plana e não na parte lateral mais fina que permite um trabalhar em perfeita ergonomia com a mão.

Art.	mm	D mm	L mm	mm
4405-08	8	17.5	148	60
4405-09	9	18.3	163	60
4405-10	10	21.3	179	72
4405-11	11	22.3	193	72
4405-12	12	24.0	204	72
4405-13	13	26.3	219	72
4405-14	14	28.2	234	72
4405-15	15	30.2	248	72
4405-16	16	32.0	259	72
4405-17	17	32.8	274	72
4405-18	18	33.6	291	72
4405-19	19	36.4	305	75

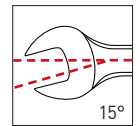
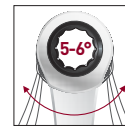
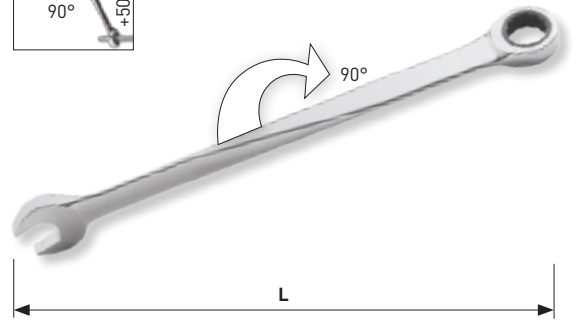
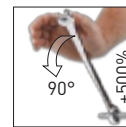

LARGO 90 combination ratchet wrench case

500 % more contact and press area grace to the 90° crossbeam forge of the wrench

Estuche de llaves combinadas con carraca LARGO 90

500 % de mayor contacto y área de presión gracias a su torsión a 90° de la llave

Jogo de chaves boca-luneta com roquete LARGO 90 em mala

500 % mais area de contacto e força graças aos 90° da nova chave

Art.	mm
4900-28K	8-9-10-11-12-13-14-15-16-17-18-19

12
PCS

COMPLETO

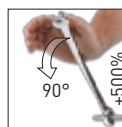

421 x 200 x 68 mm

DOUBLE RING CLICKRAFT

Double ring ratchet wrench

flat

Llave poligonal doble con carraca

plana

Chave luneta dupla com roquete

direita

Art.	○ mm	L mm	○
3441	8 x 9	130	60
3440	8 x 10	128	60 x 72
3442	10 x 11	150	72
3447	10 x 13	160	72
3443	12 x 13	170	72
3444	14 x 15	187	72
3445	16 x 18	210	72
3446	17 x 19	230	72 x 75

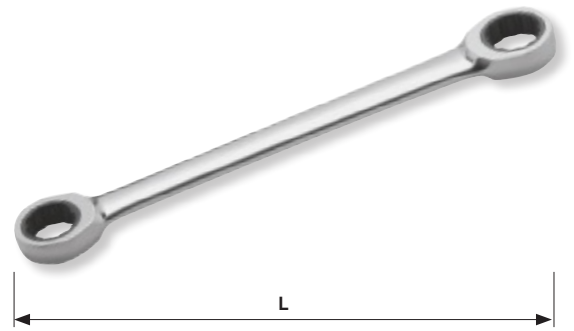

External TX double ring ratchet wrench

flat

Llave de estrella doble con carraca TX exterior

plana

Chave luneta com roquete TX exterior

direita

Art.	⊛	L mm	○
3471	E6 x E8	130	60
3472	E10 x E12	150	60
3473	E14 x E18	190	60
3474	E20 x E24	230	60

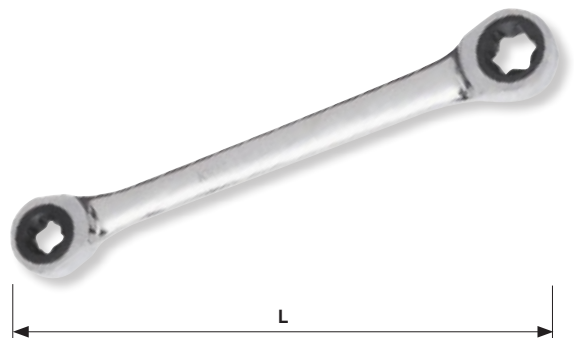

Ratchet combination wrench

reversible

Llave combinada con carraca

reversible

Chave boca-luneta com roquete

reversível

Art.	Ø mm	D mm	L mm	Ø
3404-08	8	16.8	140	60
3404-09	9	18.2	149	60
3404-10	10	20.1	159	72
3404-11	11	21.5	165	72
3404-12	12	23.0	170	72
3404-13	13	25.1	180	72
3404-14	14	27.1	190	72
3404-15	15	29.0	200	72
3404-16	16	30.6	208	72
3404-17	17	31.8	225	72
3404-18	18	32.3	236	72
3404-19	19	34.1	248	75
3404-20	20	41.7	290	72
3404-21	21	41.7	290	72
3404-22	22	41.7	290	72
3404-24	24	48.0	330	72

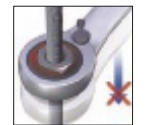
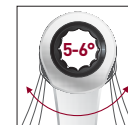
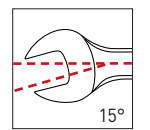
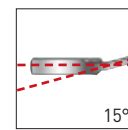
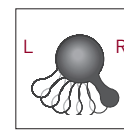

REVERSIBLE CLICKRAFT

Ratchet combination wrench set

reversible

Juego de llaves combinadas con carraca

reversibles

Jogo de chaves boca-luneta com roquete

reversíveis

Art.	mm
3404-50	10-13-17-19

4
PCS



Ratchet combination wrench set

reversible

Juego de llaves combinadas con carraca

reversibles

Jogo de chaves boca-luneta com roquete

reversíveis

Art.	mm
3404-51	8-10-12-13-17-19

6
PCS



Ratchet combination wrench set

reversible

Juego de llaves combinadas con carraca

reversibles

Jogo de chaves boca-luneta com roquete

reversíveis

Art.	mm
3404-54	8-9-10-11-12-13-14-15-16-17-18-19

12
PCS



↕ 325 x 185 x 56 mm

Ratchet combination wrench case

reversible

Estuche de llaves combinadas con carraca

reversibles

Jogo de chaves boca-luneta com roquete em mala

reversíveis

Art.	○ mm
4900-47K	8-9-10-11-12-13-14-15-16-17-18-19-22-24

4-in-1 double ring ratchet wrench

reversible

Llave poligonal doble con carraca 4-en-1

reversible

Chave luneta dupla com roquete 4-em-1

reversíveis

Art.	○ mm	L mm	○
3404-0813	8 x 10 mm 12 x 13 mm	160	72 x 72
3404-1019	10 x 13 mm 17 x 19 mm	200	72 x 75
3404-1619	16 x 17 mm 18 x 19 mm	230	72 x 75
3404-51612	5/16" x 3/8" 7/16" x 1/2"	160	72 x 72
3404-91634	9/16" x 5/8" 11/16" x 3/4"	210	72 x 75

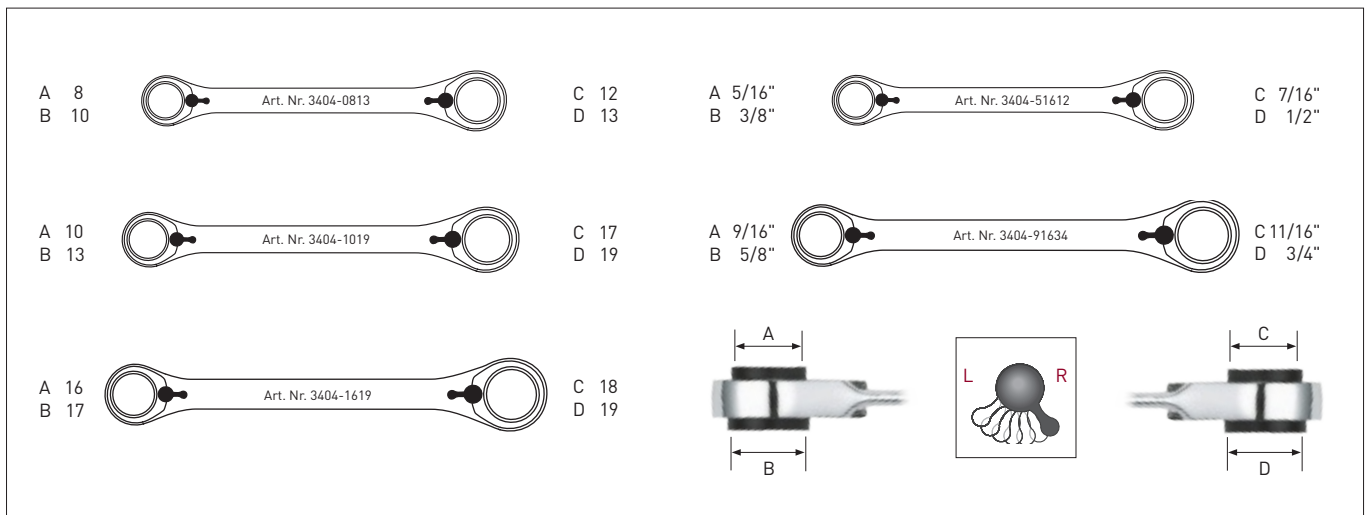

14
PCS



COMPLETO



421 x 200 x 68 mm

QUAD REVERSIBLE CLICKRAFT



4in1



QUAD REVERSIBLE CLICKRAFT

4-in-1 double ring ratchet wrench set

reversible

Juego de llaves poligonales doble con carraca

4-en-1

reversibles

Jogo de chaves luneta dupla com roquete

4-em-1

reversíveis

2
PCS



250 x 110 x 35 mm

Art.	mm
3404-4x2	8 x 10 / 12 x 13 16 x 17 / 18 x 19

Ratchet combination wrench

flexible

Llave combinada con carraca

flexible

Chave boca-luneta com roquete

flexível

Art.	mm	D mm	L mm	mm
3403-08	8	17.0	140	60
3403-09	9	19.0	149	60
3403-10	10	20.0	158	72
3403-11	11	22.0	165	72
3403-12	12	23.0	171	72
3403-13	13	25.0	176	72
3403-14	14	27.5	190	72
3403-15	15	29.0	199	72
3403-16	16	30.0	208	72
3403-17	17	32.0	225	72
3403-18	18	34.0	236	72
3403-19	19	34.3	248	75
3403-20	20	42.0	290	72
3403-21	21	42.0	290	72
3403-22	22	42.0	290	72
3403-24	24	49.0	333	72

FLEX CLICKRAFT

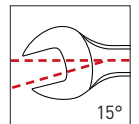
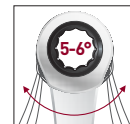

Ratchet combination wrench set

flexible

Juego de llaves combinadas con carraca

flexibles

Jogo de chaves boca-luneta com roquete

flexíveis

Art.	mm
3403-51	8-10-12-13-17-19

6
PCS



Ratchet combination wrench set

flexible

Juego de llaves combinadas con carraca

flexibles

Jogo de chaves boca-luneta com roquete

flexíveis

Art.	mm
3403-54	8-9-10-11-12-13-14-15-16-17-18-19

12
PCS



↕ 325 x 185 x 56 mm

Ratchet combination wrench case

flexible

Estuche de llaves combinadas con carraca

flexibles

Jogo de chaves boca-luneta com roquete em mala

flexíveis

Art.	mm
4900-46K	8-9-10-11-12-13-14-15-16-17-18-19-22-24

14
PCS



COMPLETO



↕ 421 x 200 x 68 mm

STUBBY FLEX CLICKRAFT

Ratchet combination wrench

flexible, Stubby

Llave combinada con carraca

flexible, corta

Chave boca-luneta com roquete

flexível, curta

Art.	mm	D mm	L mm	mm
3403-08S	8	17.0	88	60
3403-10S	10	20.0	94	72
3403-11S	11	22.0	102	72
3403-12S	12	23.0	105	72
3403-13S	13	25.0	107	72
3403-14S	14	27.5	114	72

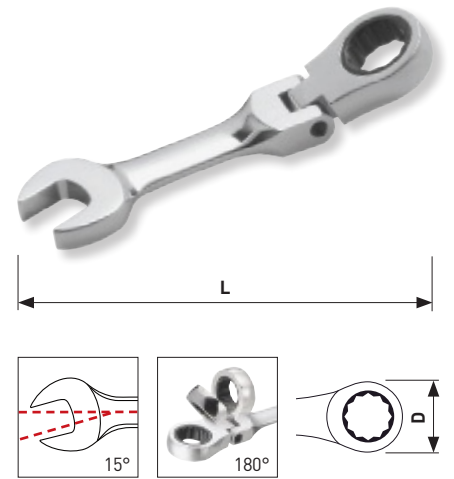

Ratchet combination wrench

swivelling laterally stepless up to 180° for ratcheting even at badly accessible places. Locking knob for fixation of the angle

Llave combinada con carraca

oscilante lateralmente sin escalonamiento hasta 180° para trabajar en sitios de muy difícil acceso. Botón de bloqueo para fijar el ángulo

Chave boca-luneta com roquete

angular sem escala até 180° lateral para trabalhar em sítios de acesso limitado. Sistema de bloqueio para o ângulo

Art.	mm	D mm	L mm	mm
3402-08	8	17.0	151	60
3402-09	9	17.9	164	60
3402-10	10	19.8	179	72
3402-11	11	21.6	194	72
3402-12	12	23.0	205	72
3402-13	13	24.7	219	72
3402-14	14	26.3	233	72
3402-15	15	28.4	247	72
3402-16	16	30.5	257	72
3402-17	17	31.8	272	72
3402-18	18	33.2	287	72
3402-19	19	34.0	303	75

ANGLE CLICKRAFT

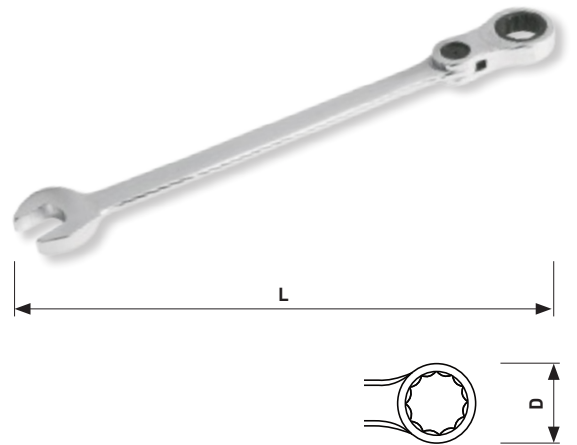

Ratchet combination wrench case

swivelling laterally stepless up to 180° for ratcheting even at badly accessible places. Locking knob for fixation of the angle

Estuche de llaves combinadas con carraca

oscilantes lateralmente sin escalonamiento hasta 180° para trabajar en sitios de muy difícil acceso. Botón de bloqueo para fijar el ángulo

Jogo de chaves boca-luneta com roquete em mala

angular e sem escala até 180° lateral para trabalhar em sítios de acesso limitado. Sistema de bloqueio para o ângulo

*Option / Opcionales / Opção



Art.	mm
4900-41K	8-9-10-11-12-13-14-15-16-17-18-19

Socket- and bit-adapter set

Juego de adaptador para llaves de vaso y portapuntas

Jogo de adaptadores para chaves de caixa e bits

Art.	mm	mm + mm	D mm
3691	10	1/4" + 1/4"	20

Socket adapter

Adaptador para llaves de vaso

Adaptador para chaves de caixa

Art.	mm	mm	D mm
3692	13	3/8"	25

Socket adapter

Adaptador para llaves de vaso

Adaptador para chaves de caixa

Art.	mm	mm	D mm
3693	19	1/2"	35

12
PCS



COMPLETO



421 x 200 x 68 mm

CLICKRAFT

1/4"

1/4"

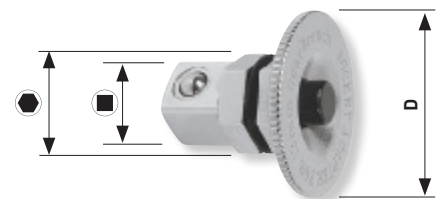

3/8"

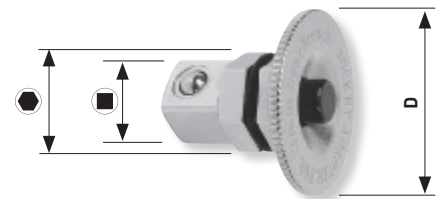

1/2"

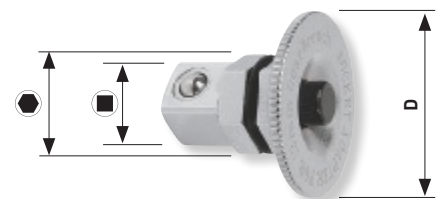

Combination wrench

mirror polished

Llave combinada

pulido brillante

Chave de boca-luneta

polida

Art.	Ø mm	L mm
3505	5.5	127
3506	6	127
3507	7	134
3508	8	140
3509	9	150
3510	10	159
3511	11	165
3512	12	172
3513	13	179
3514	14	191
3515	15	199
3516	16	206
3517	17	225
3518	18	235
3519	19	248
3520	20	272
3521	21	272
3522	22	291
3523	23	315
3524	24	315
3525	25	335
3526	26	335
3527	27	358
3528	28	402
3530	30	425
3532	32	425
3534	34	375
3536	36	395
3538	38	400
3541	41	435
3546M	46	485
3550M	50	525

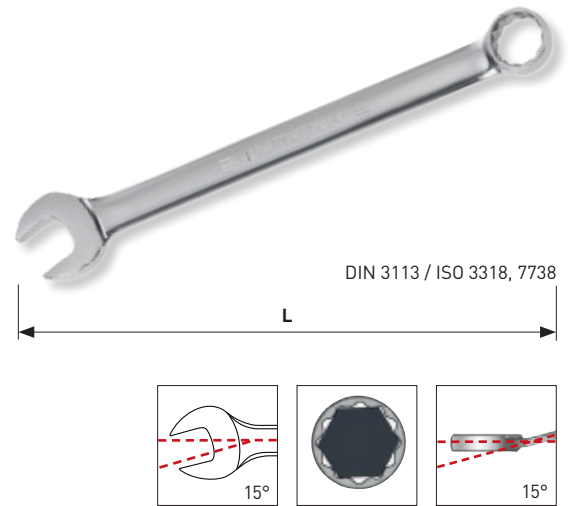

Combination wrench set

mirror polished, with plastic carrying holder

Juego de llaves combinadas

pulido brillante, en petaca con asa de material plástico

Jogo de chaves de boca-luneta

polidas, com suporte plástico

10
PCS



Art.	○ mm
3556	8-9-10-11-12-13 14-15-17-19

Combination wrench set

mirror polished

Juego de llaves combinadas

pulido brillante

Jogo de chaves de boca-luneta

polidas

13
PCS



Art.	○ mm
3550	8-9-10-11-12-13-14 15-16-17-18-19-22

Combination wrench set

mirror polished

Juego de llaves combinadas

pulido brillante

Jogo de chaves de boca-luneta

polidas

18
PCS

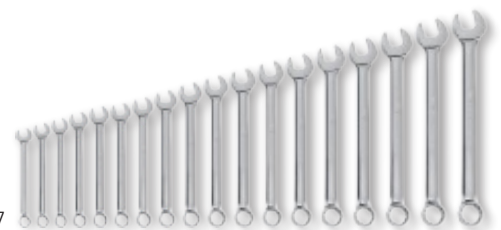

Art. 3557

Art.	○ mm
3557	5.5-6-7-8-9-10-11-12-13-14 15-16-17-18-19-20-21-22
3557R	5.5-6-7-8-9-10-11-12-13-14 15-16-17-18-19-20-21-22



Art. 3557R

Canvas

↕ 540 x 420 mm

Double open-end wrench set

mirror polished

Juego de llaves fijas

pulido brillante

Jogo de chaves de bocas

polidas

Art.	mm
3553	6x7-8x9-10x11-12x13-14x15-16x17 18x19-21x22-24x27-30x32
3553R	6x7-8x9-10x11-12x13-14x15-16x17 18x19-21x22-24x27-30x32

CrV **10**
PCS



Art. 3553



Art. 3553R

Canvas

Combination wrench set

mirror polished

Juego de llaves combinadas

pulido brillante

Jogo de chaves de boca-luneta

polidas

Art.	mm
3558	24-27-30-32
3558R	24-27-30-32

4
PCS



Art. 3558



Art. 3558R

Canvas

↕ 485 x 295 mm

Combination wrench set

mirror polished

Juego de llaves combinadas

pulido brillante

Jogo de chaves de boca-luneta

polidas

Art.	mm
3554	5.5-6-7-8-9-10-11-12-13-14-15-16-17-18-19 20-21-22-23-24-25-26-27-28-30-32
3554R	5.5-6-7-8-9-10-11-12-13-14-15-16-17-18-19 20-21-22-23-24-25-26-27-28-30-32

CrV

26
PCS



Art. 3554



Art. 3554R

Canvas

Combination wrench set
of stainless steel

Juego de llaves combinadas
en acero inoxidable

Jogo de chaves de boca-luneta
em aço inoxidável



Art.	mm
3503-56	8-10-11-12-13-14-15-17-19

inox

9
PCS



Inch combination wrench
mirror polished

Llave combinada pulgadas
pulido brillante

Chave de boca-luneta polegada
polida

Art.	inch	L mm
3587	1/4"	126
3588	5/16"	139
3589	3/8"	160
3590	7/16"	166
3591	1/2"	178
3592	9/16"	190
3593	5/8"	208
3594	11/16"	226
3595	3/4"	250
3596	13/16"	271
3597	7/8"	294
3598	15/16"	314
3599	1"	335

inch

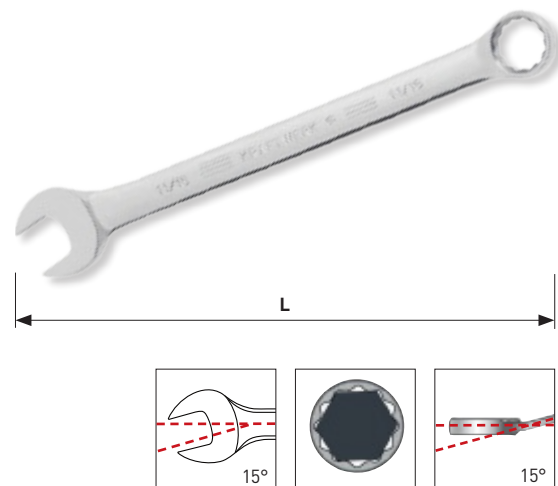

Inch combination wrench set

mirror polished

Juego de llaves combinadas en pulgadas

pulido brillante

Jogo de chaves de boca-luneta polegadas

polidas

inch

11
PCS



Art. 3585

Art.	inch
3585	3/8"-7/16"-1/2"-9/16"-5/8"-11/16" 3/4"-13/16"-7/8"-15/16"-1"
3585R	3/8"-7/16"-1/2"-9/16"-5/8"-11/16" 3/4"-13/16"-7/8"-15/16"-1"



Art. 3585R

Canvas

485 x 400 mm

Inch combination wrench case

mirror polished, with 2 reversible ring ratchet wrenches 4-in-1

Estuche de llaves combinadas en pulgadas

pulido brillante, con 2 llaves poligonales dobles con carraca reversible 4-en-1

Mala de chaves de boca-luneta polegadas

polidas, com 2 chaves luneta com roquete reversível 4-em-1

inch

15
PCS



COMPLETO

402 x 173 x 48 mm

4in1

REVERSIBLE CLICKRAFT

A 5/16" Art. Nr. 3404-51612 A 7/16"
B 3/8" B 1/2"

A 9/16" Art. Nr. 3404-91634 A 11/16"
B 5/8" B 3/4"

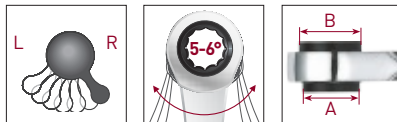

Art.	inch
4900-30K	1/4"-5/16"-3/8"-7/16"-1/2"-9/16"-5/8" 11/16"-3/4"-13/16"-7/8"-15/16"-1"

Double open end wrench

mirror polished

Llave fija

pulido brillante

Chave de bocas

polida

Art.	○ mm	L mm
3560	6 x 7	125
3561	8 x 9	137
3562	10 x 11	149
3551	10 x 13	162
3563	12 x 13	162
3564	14 x 15	188
3565	16 x 17	203
3552	17 x 19	227
3566	18 x 19	227
3567	21 x 22	252
3568	24 x 27	280
3569	30 x 32	310
3579	36 x 41	350
3583	46 x 50	440
3586	55 x 60	505

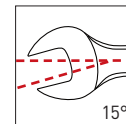

Double open end wrench set

mirror polished

Juego de llaves fijas

pulido brillante

Jogo de chaves de bocas

polidas

Art.	○ mm
3570	6x7-8x9-10x11-12x13-14x15 16x-17-18x19-21x22
3570R	6x7-8x9-10x11-12x13-14x15 16x-17-18x19-21x22

8
PCS



Art. 3570



Art. 3570R

Canvas

↕ 330 x 310 mm

Adjustable angle wrench

with scale

Llave ajustable

con escala

Chave crescente

com escala

Art.	mm	L mm / inch
2404	0 - 14	100 / 4"
2406	0 - 20	150 / 6"
2408	0 - 25	200 / 8"
2410	0 - 30	250 / 10"
2412	0 - 35	300 / 12"
2415	0 - 45	375 / 15"
2418	0 - 55	450 / 18"



Adjustable angle wrench

with specially wide adjustable jaws, slim head with ground jaws and scale in millimeter/inch. Precise and smooth-running guide rail. Parkerized finish.

Llave ajustable

con apertura extra grande, cabeza fina con escala en mm/pulgadas. Precisión y flexibilidad en la separación de las mordazas. Acabado parquerizado.

Chave crescente

Com mandíbulas especialmente longas, cabeça fina com mandíbulas e escala em milímetros/polegada. Carril guia preciso e suave. Acabamento parkerizado.

Art.	mm	L mm / inch
47122	0 - 27	150 / 6"
47123	0 - 34	200 / 8"
47124	0 - 36	250 / 10"
47125	0 - 45	300 / 12"
47120	47122 + 47123 + 47124	

CrV

HIGHTECH



3
PCS



Art. 47120

Canvas

One for many – the Duo Quick universal wrench

with quick adjustment. Release the jaw with one easy pull on the knob. Push the jaw to the screw with the thumb – the jaw is firmly and accurate fixed to the millimeter/inch and shows the screw size on the metric and the inch scale. The Duo Quick wrench replaces every conventional metric or inch wrench up to 24 mm / 1 inch.

Uno para muchos – la llave universal Duo Quick

con ajuste rápido. Libera las bocas simplemente al tirar del botón. Empuje con el dedo pulgar la boca hasta la fijación firme del tornillo, indica la medida del tornillo en escala métrica/pulgada.

La llave Duo Quick reemplaza cualquier llave convencional métrica o en pulgada, hasta 24 mm / 1".

Uma para muitas – A chave crescente Duo Quick

com ajuste rápido. Liberte a maxila com um simples carregar de botão. Acerte a maxila com o parafuso – a maxila está firme e certa na escala de milímetros/polegadas, indicando assim a medida do parafuso na escala. A chave Duo Quick substitui qualquer chave crescente métrica ou polegadas até 24 mm / 1 polegada.



Art.	mm / inch	L mm / inch
3582	0 - 26 / 0 - 1"	200 / 8"

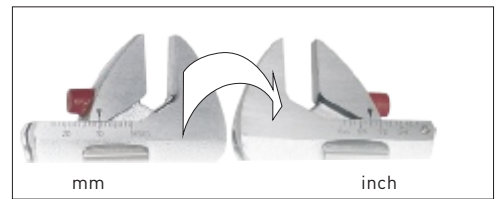
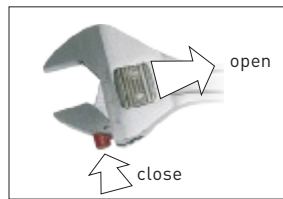

Adjustable ratchet angle wrench

for the fast tightening and loosening of 4-point and 6-point screws/nuts without disengaging the wrench while working. Ratcheting on/off switch to select movable or fixed wrench head. Ergonomic 2-component handle.

CrMo

ERGOKRAFT

Llave ajustable con carraca

para apretar o aflojar los tornillos de 4-6 puntos sin retirar la llave mientras se trabaja. Provisto de un sistema revolucionario para seleccionar cabeza de la llave fija o móvil. Mango ergonómico bimatérica.

Chave crescente com roquete

para apertar e desapertar parafusos com 4 e 6 lados sem retirar a chave. Com um sistema revolucionário para soltar a mandíbula. Punho ergonómico em bi-matéria.

Art.	mm / inch	L mm / inch
3577	0 - 25 / 0 - 1"	210 / 8.27"

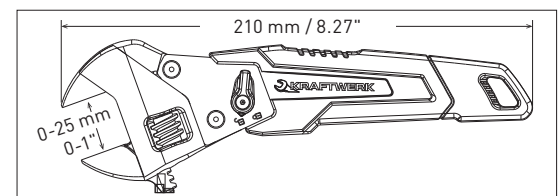
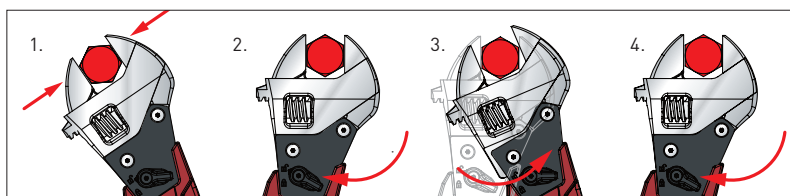

Double offset ring wrench

mirror polished

Llave estrella dos bocas

pulido brillante

Chave de luneta

polida

Art.	mm	L mm
3480	6 x 7	165
3481	8 x 9	180
3482	10 x 11	199
3483	12 x 13	218
3484	14 x 15	238
3485	16 x 17	262
3486	18 x 19	287
3487	20 x 22	317
3488	21 x 23	329
3489	24 x 27	346
3491	30 x 32	369
3492	36 x 41	460
3493	46 x 50	520
3494	55 x 60	620

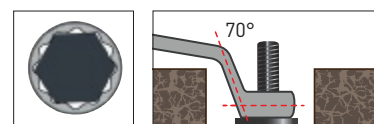

Double offset ring wrench set

mirror polished

Juego de llaves estrella dos bocas

pulido brillante

Jogo de chaves luneta

polidas

Art.	mm
3497	6x7-8x9-10x11-12x13-14x15 16x17-18x19-20x22
3497R	6x7-8x9-10x11-12x13-14x15 16x17-18x19-20x22

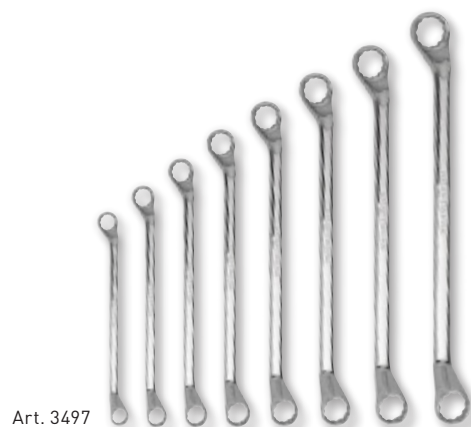

Canvas

450 x 390 mm

Double offset ring wrench set

mirror polished

Juego de llaves estrella dos bocas

pulido brillante

Jogo de chaves luneta

polidas

Art.	⊙ mm
3498	21x23 - 24x27 - 25x28 - 30x32
3498R	21x23 - 24x27 - 25x28 - 30x32

4
PCS



Art. 3498



Art. 3498R

Canvas

↕ 460 x 325 mm

Double offset ring wrench case

mirror polished

Estuche de llaves estrella dos bocas

pulido brillante

Mala de chaves luneta

polidas

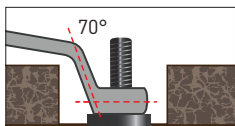

Art.	⊙ mm
4900-15K	6x7-8x9-10x11-12x13-14x15-16x17 18x19-20x22-21x23-24x27-30x32

11
PCS



COMPLETO

↕ 421 x 200 x 68 mm

External TX double ring wrench

flat, mirror polished

Llave de estrella doble TX exterior

recta, pulido brillante

Chave de luneta TX exterior

direita, polida

Art.	⊙ E	L mm
3546	E6 x E8	112
3547	E10 x E12	140
3548	E14 x E18	180
3549	E20 x E24	223

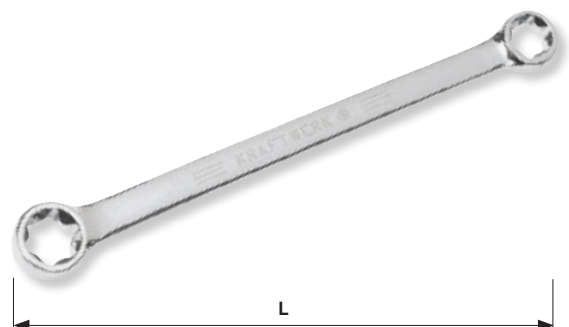

External TX double ring wrench set

flat, mirror polished

Juego de llaves de estrella doble TX exterior

rectas, pulido brillante

Jogo de chaves de luneta TX exterior

direitas, polidas

4
PCS



Art.	⊙ E
3545	E6xE8 - E10xE12 - E14xE18 - E20xE24

Flare nut wrench

mirror polished

Llave para racores

pulido brillante

Chave de luneta aberta

polida

Art.	⊙ mm	⊙ inch	L mm
3580-00	9 x 11		173
3580-01	10 x 12		175
3580-02	13 x 14		208
3580-03	15 x 17		245
3580-04		3/8" x 7/16"	173
3580-05		1/2" x 9/16"	208
3580-06		5/8" x 11/16"	250



Flare nut wrench set

mirror polished

Juego de llaves para racores

pulido brillante

Jogo de chaves de luneta aberta

polidas

7
PCS



Art.	⊙ mm / inch
3580	9x11 - 10x12 - 13x14 - 15x17 3/8"x7/16" - 1/2"x9/16" - 5/8"x11/16"

Elbow milled angle socket wrench 6 x 6 point

mirror polished

Llave de pipa abierta 6 x 6

pulido brillante

Chave de cachimbo aberta 6 x 6

polida



NF ISO 2236



Art.	Ø mm	L ± mm
2597-06	6	102 ± 3
2597-07	7	106 ± 3
2597-08	8	114 ± 3
2597-09	9	122 ± 3
2597-10	10	129 ± 3
2597-11	11	136 ± 3
2597-12	12	144 ± 4
2597-13	13	152 ± 4
2597-14	14	160 ± 4
2597-15	15	169 ± 4
2597-16	16	178 ± 4
2597-17	17	187 ± 4
2597-18	18	195 ± 4
2597-19	19	204 ± 4
2597-20	20	212 ± 4
2597-21	21	221 ± 5
2597-22	22	230 ± 5
2597-23	23	240 ± 5
2597-24	24	250 ± 5
2597-25	25	260 ± 5
2597-26	26	270 ± 5
2597-27	27	280 ± 5
2597-28	28	290 ± 5
2597-29	29	300 ± 5
2597-30	30	310 ± 5
2597-32	32	330 ± 5

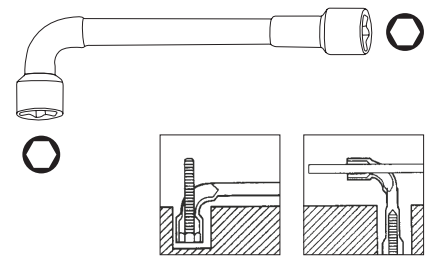

Elbow milled angle socket wrench 12 x 6 point

mirror polished

Llave de pipa abierta 12 x 6

pulido brillante

Chave de cachimbo aberta 12 x 6

polida



NF ISO 2236

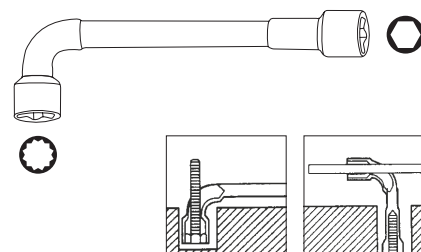

Art.	Ø mm	L ± mm
2598-06	6	102 ± 3
2598-07	7	106 ± 3
2598-08	8	114 ± 3
2598-09	9	122 ± 3
2598-10	10	129 ± 3
2598-11	11	136 ± 3
2598-12	12	144 ± 4
2598-13	13	152 ± 4
2598-14	14	160 ± 4
2598-15	15	169 ± 4
2598-16	16	178 ± 4
2598-17	17	187 ± 4
2598-18	18	195 ± 4
2598-19	19	204 ± 4
2598-20	20	212 ± 4
2598-21	21	221 ± 5
2598-22	22	230 ± 5
2598-23	23	240 ± 5
2598-24	24	250 ± 5
2598-25	25	260 ± 5
2598-26	26	270 ± 5
2598-27	27	280 ± 5
2598-28	28	290 ± 5
2598-29	29	300 ± 5
2598-30	30	310 ± 5
2598-32	32	330 ± 5
2598-34	34	350 ± 5

Elbow milled angle socket wrench set



mirror polished

Juego de llaves de pipa abiertas

pulido brillante

Jogo de chaves de cachimbo abertas

polidas

Art.			mm
2597-99	○	○	8-10-11-12-13-14-16-17-18-19
2598-99	○	○	8-10-11-12-13-14-16-17-18-19



10
PCS



Elbow milled open socket wrench case

mirror polished



Estuche de llaves de pipa abiertas

pulido brillante

Mala de chaves de cachimbo abertas

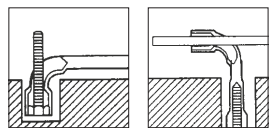
polidas



Art.			mm
4900-48K	○	○	8-9-10-11-12-13-14-15 16-17-18-19-22
4900-18K	○	○	8-9-10-11-12-13-14-15 16-17-18-19-22



13
PCS



COMPLETO

421 x 200 x 68 mm

Double flexible socket wrench

mirror polished

Llave de vaso doble articulada

pulido brillante

Chave de caixa articulada

polida

Art.	mm	L mm
2590-0809	8 x 9	176
2590-1011	10 x 11	200
2590-1213	12 x 13	216
2590-1415	14 x 15	240
2590-1617	16 x 17	255
2590-1819	18 x 19	270

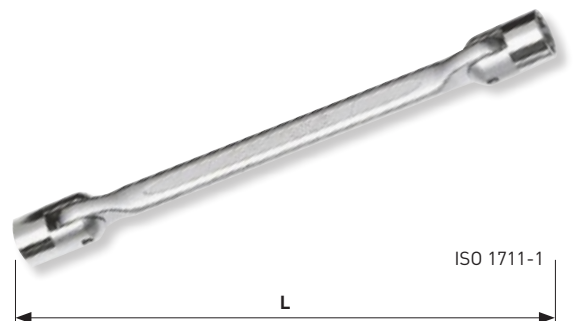

ISO 1711-1

L



Double flexible wrench for sockets

mirror polished

Llave doble articulada para llaves de vaso

pulido brillante

Chave dupla articulada para chaves de caixa

polida

Art.	■	L mm
2590-3814	1/4" x 3/8"	255

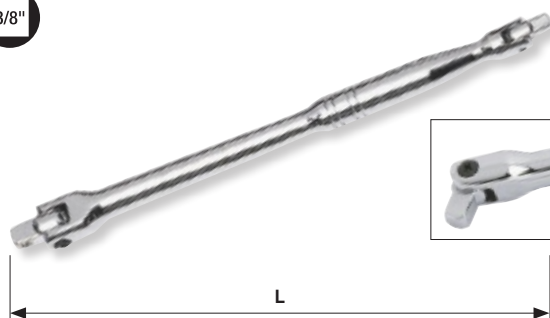

Universal joint spark plug wrench

Llave de bujía articulada

Chave de velas articulada

Art.	○ mm	L mm
2591-16	16	240
2591-21	21	245

AUTOMOTIVE

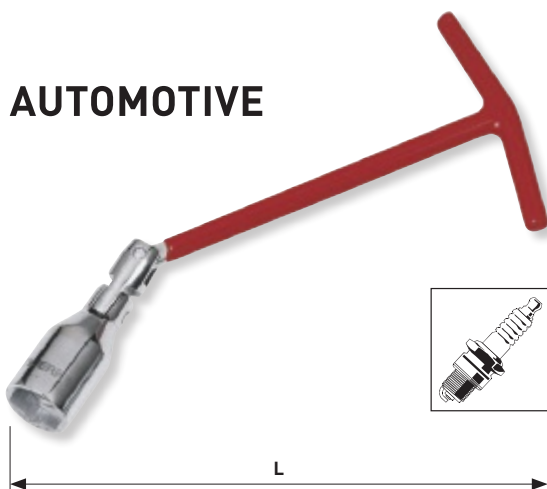

L-type wheel wrench with double socket

extensible

Llave ruedas en L con llave de vaso doble

extensible

Chave de rodas tipo L com chave dupla

extensível

Art.	○ mm	L 1 mm	L 2 mm
2585-1719	17 x 19	365	525
2585-1721	21 x 22	365	525

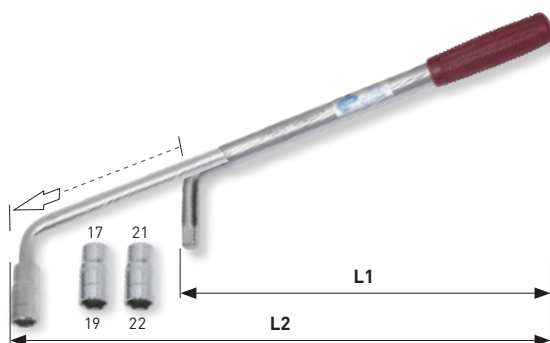

Cross rim wrench

Llave ruedas cruz

Chave de rodas em cruz

Art.	○ mm	■	L mm
2585-12	17-19-22	1/2"	375
2585-34	24-27-32	3/4"	625



T-type universal socket

extra long

Llave de vaso en T muletilla

extra larga

Chave de caixa cabo em "T"

extra longa

Art.	⊙ mm	L mm
2592-08	8	390
2592-09	9	390
2592-10	10	495
2592-11	11	495
2592-12	12	495
2592-13	13	495
2592-14	14	495
2592-15	15	495
2592-16	16	495
2592-17	17	495
2592-18	18	495
2592-19	19	495

XXL

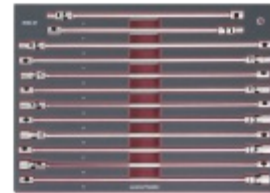
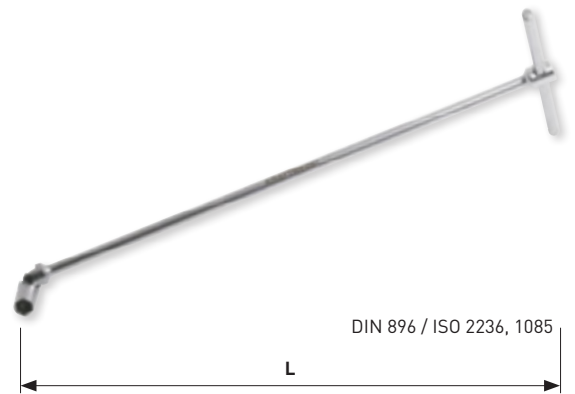

Art. 4902-07
95

Double end tubular socket wrench

light serie

Llave de tubo de dos bocas

serie ligera

Chave de tubos direita

série ligeira

Art.	⊙ mm	∅ mm	L mm
2589-0607	6 x 7	5	108
2589-0809	8 x 9	5	110
2589-1011	10 x 11	5	122
2589-1213	12 x 13	5	142
2589-1415	14 x 15	8	143
2589-1617	16 x 17	10	146
2589-1819	18 x 19	10	158
2589-2022	20 x 22	10	175
2589-2123	21 x 23	12	175
2589-2427	24 x 27	12	185
2589-2528	25 x 28	12	190
2589-3032	30 x 32	12	205

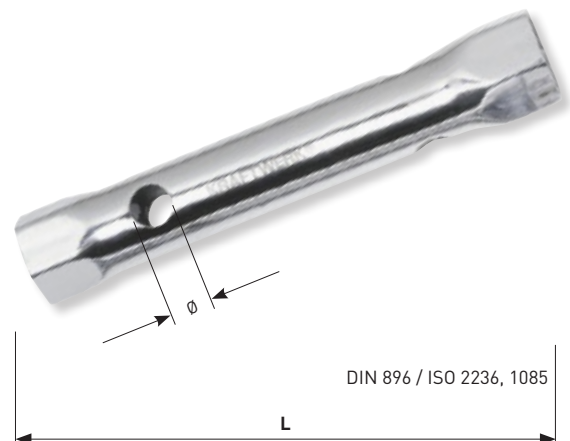

Double end tubular socket wrench set

light serie

Juego de llaves de tubo de dos bocas

serie ligera

Jogo de chaves de tubos direita

série ligeira

Art.	∅ mm	∅ mm
2589-01	6x7-8x9-10x11-12x13 14x15-16x17-18x19-20x22	5-8-10

9
PCS



Canvas

↕ 325 x 240 mm

Double end tubular socket wrench set

light serie

Juego de llaves de tubo de dos bocas

serie ligera

Jogo de chaves de tubos direita

série ligeira

Art.	∅ mm	∅ mm
2589-02	21x23 - 24x27 - 25x28 - 30x32	12+14

6
PCS



Canvas

↕ 370 x 345 mm

Stepped tommy bar

for double end tubular socket wrenches

Pasador

para llaves de tubo de dos bocas

Barra T escalonada

para chaves de tubos direita

Art.	∅ mm	L mm
2599-3457	3.5 - 4.5 - 5.5 - 7.5	165
2589-5810	5 - 8 - 10	190
2599-1012	10 - 12	210

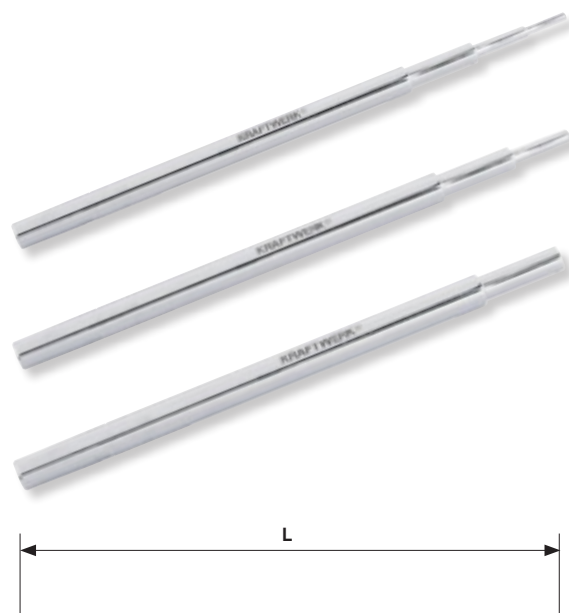

Double end tubular socket wrench

heavy duty serie, made by CNC-machining

Llave de tubo de dos bocas

serie fuerte, fabricada con precisión CNC

Chave de tubos direita

série maciça, fabricada com precisão CNC

Art.	mm	Ø mm	L mm
2599-0607	6 x 7	3.5	105
2599-0809	8 x 9	3.5	110
2599-1011	10 x 11	4.5	120
2599-1213	12 x 13	5.5	138
2599-1415	14 x 15	5.5	145
2599-1617	16 x 17	8	152
2599-1819	18 x 19	8	162
2599-2022	20 x 22	10	175
2599-2123	21 x 23	10	185
2599-2427	24 x 27	12	195
2599-2528	25 x 28	12	205
2599-3032	30 x 32	12	210

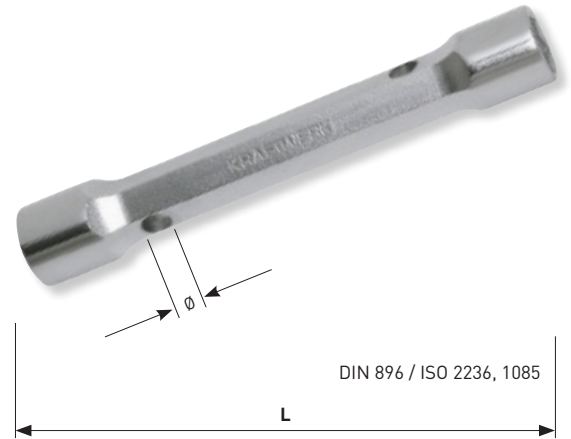

Double end tubular socket wrench set

heavy duty serie, made by CNC-machining

Juego de llaves de tubo de dos bocas

serie fuerte, fabricada con precisión CNC

Jogo de chaves de tubos direita

série maciça, fabricada com precisão CNC

Art.	mm	Ø mm
2599-01	6x7-8x9-10x11-12x13 14x15-16x17-18x19-20x22	5-8-10

9
PCS



Canvas

325 x 240 mm

Double end tubular socket wrench set

heavy duty serie, made by CNC-machining

Juego de llaves de tubo de dos bocas

serie fuerte, fabricada con precisión CNC

Jogo de chaves de tubos direita

série maciça, fabricada com precisão CNC

Art.	○ mm	∅ mm
2599-02	21x23 - 24x27 - 25x28 - 30x32	10+12

6
PCS



Canvas

↕ 370 x 345 mm

Ring ratchet wrench set for tubes

Juego de llaves poligonales con carraca para racores

Jogo de chaves luneta com roquete para racores

Art.
2586

CrMo 8
PCS



Canvas

Reversible ratchet head

Cabeza carraca reversible

Cabeça de roquete reservível

Art.	■
3584-U14	1/4"
3584-U38	3/8"

