

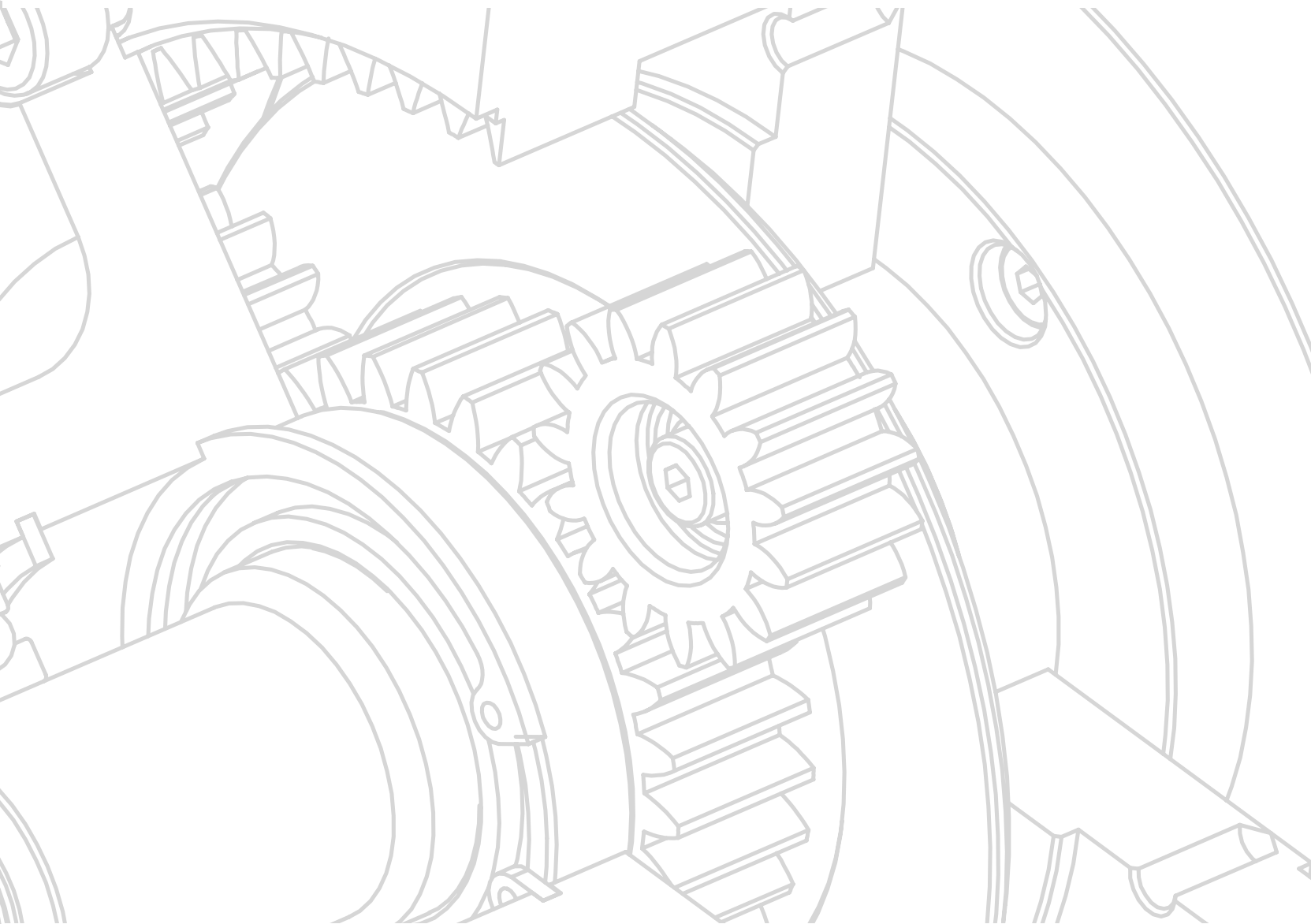

Drive and stirring technology for

FOOD | PHARMACEUTICALS | CHEMICALS | COSMETICS | AUTOMATION



WE GENERATE MOVEMENT IN SPECIAL ENVIRONMENTS.

**FULL-SERVICE PROVIDER
FOR DRIVE AND
STIRRING TECHNOLOGY.**

PREFACE	2 / 3
COMPANY HISTORY	4 / 5
FULL SERVICE, STANDARD AND CUSTOMISED SOLUTIONS	6 / 7
ENERGY-EFFICIENCY	8 / 9

STIRRING TECHNOLOGY	22 / 23
System agitators	24 / 25
Drum agitators	26 / 27
Accessories drum agitators	28 / 29
Stirring stations	30 / 31
Container agitators	32 / 33
Stainless-steel agitators	34 / 35
Hand-held agitators	36 / 37
Laboratory agitators	38 / 39
Impellers	40
Simulation	41
Suction lances & quick-change systems	42 / 43

DRIVE TECHNOLOGY	44 / 45
BASIC motor	46 / 47
ATEX motor	48
IP68 waterproof motor	49
Stainless-steel motor	50
Ferrite-free motor	51
Accessories motors	52 / 53

INDUSTRIES	11
CHEMICALS	12 / 13
FOOD	14 / 15
PHARMA	16 / 17
COSMETIC	18 / 19
AUTOMATION	20 / 21

SUSTAINABILITY & ENVIRONMENT	54 / 55
NOTES	56 / 57

PRE
PRE
PRE

FACE
FACE
FACE



DEAR READER,

A GOOD PRICE, A HIGH PRODUCT DURABILITY,
„IT DOES WHAT IT IS SUPPOSED TO DO“... IS THAT
REALLY WHAT MAKES A PRODUCT A GOOD PRODUCT?
THAT SOUNDS SOLID ENOUGH, BUT IS THAT
REALLY SUFFICIENT?

WE, THE PTM MECHATRONICS TEAM, ARE
COMMITTED TO THE MISSION
OF BEING MORE THAN JUST THE SIMPLE
ANSWER TO A QUESTION.

OUR ASPIRATION IS TO NOT ONLY PROVIDE
OUR CUSTOMERS WITH THE PRODUCT THEY EXPECT,
BUT WE STRIVE TO EXCEED THEIR
EXPECTATIONS. SPECIAL FEATURES, INNOVATIVE IDEAS.
REGARDING NOT ONLY OUR PRODUCTS BUT ALSO
OUR CONSULTING AND SERVICES AS WELL AS
OUR PROJECT MANAGEMENT AND COMMUNICATION.

THINKING AHEAD, THINKING OUTSIDE THE BOX, BREAKING
NEW GROUND, MAKING THINGS BETTER - THAT IS OUR
PASSION, THAT IS WHAT DRIVES US EVERY DAY.

PTM MECHATRONICS
- WE GENERATE MOVEMENT IN SPECIAL ENVIRONMENTS.

BEST REGARDS,
SARAH & CARSTEN ANGERMEYER



1988

- 1989
- 1990
- 1991
- 1992

1993

- 1994
- 1995
- 1996
- 1997
- 1998
- 1999

2000

2001

2002

2003

2004

2005

2006

2007

2008

2009

2010

2011

2012

2013

2014

2015

2016

2017

2018

2019

2020

2021

2022

2023

2024

2025

2026



COMPANY HISTORY

PTM mechatronics was founded over 30 years ago. The company's roots are in pneumatic drive technology for which the company's first of many patents was registered in 1993. In 2002, the pneumatic radial piston motor was developed and has been at the center of PTM mechatronics's business ever since. Over the years it has proven to be a reliable high-performance and energy-efficient motor and is therefore today at the heart of our pneumatic stirring technology eco-Series. Continuously expanding our product range, our product portfolio today is completed by electric components and drives.

Years of practical experience from numerous projects make us experts in the realisation of customised solutions, ATEX, clean room, protection class IP68, food-safety, stainless steel and the compliance with all occupational safety requirements. Besides ISO 9001:2015, PTM mechatronics has a quality management system for the manufacturing of Ex products according to ISO/IEC80079-34:2018-08 since 2017. Thereby, we

are entitled to develop ATEX-certified serial products of ATEX zone 0 and, after a type examination conducted by TÜV Süd, manufacture them in series and distribute them without any further TÜV conformity assessment.

In 2019, the stirring technology eco-Series with its GENERATION 2.19 (see pages 23ff.) was honoured with the Red Dot Design Award for its clear-cut shape and its pioneering functional details. Honoured as well was the quick-change system for agitator shafts eco-Quick for its practical functionality and its high problem-solving competence (see page 43).

Today the team of PTM mechatronics is your professional partner in all fields of drive and stirring technology. Regarding customised solutions, our experts accompany you through all project steps supported by our structured project management system:

Consulting, development, production, installation and continued reliable support also after your project has been finished. We offer you a suitable standard product portfolio and trendsetting technologies.

FULL SERVICE – 360°

Whether it is a standard product or a customised solution, which expectations do you have when it comes to the fulfilment of your requirements? Us here at the PTM mechatronics team save you long hours of searching the internet, the cumbersome assembling of different components and the time-consuming collecting of information. We offer you a comprehensive service to cover all aspects:

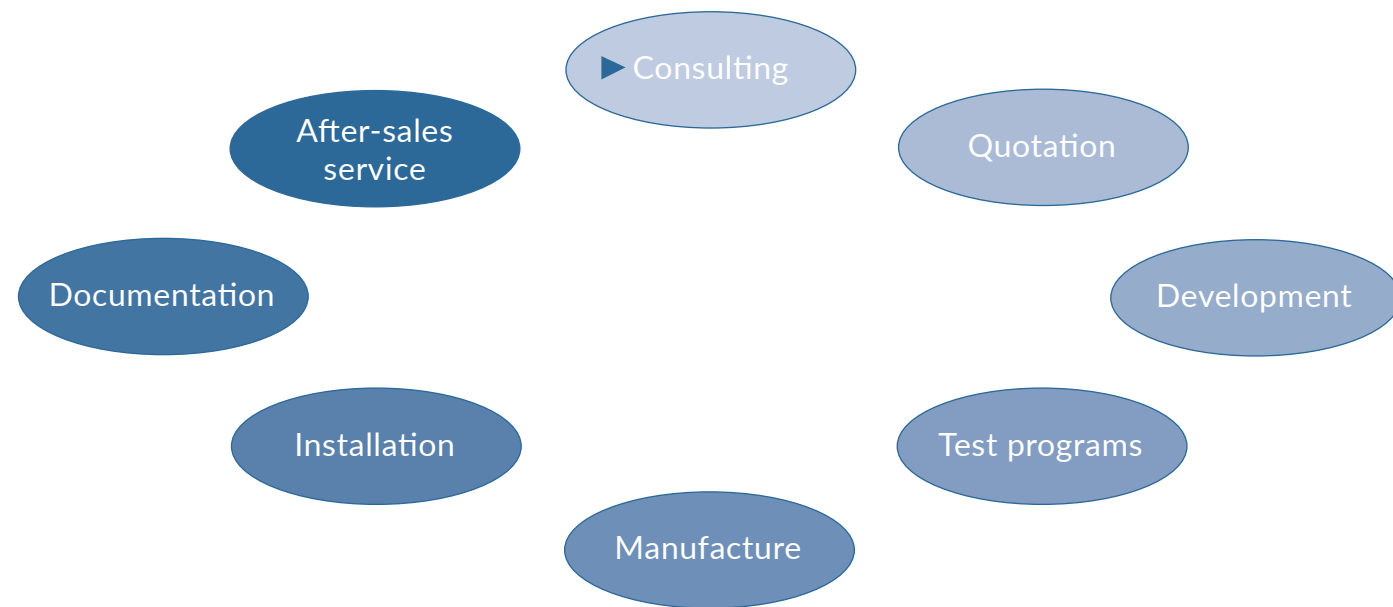

STANDARD SOLUTIONS

Our product range includes stirring and drive technology products:

STIRRING TECHNOLOGY (see page 23):

Our stirring technology is perfectly tailored to the different needs and stirring processes of our customers. Our portfolio includes flexible stirring drives, hand-held agitators, drum agitators, IBC container agitators and laboratory agitators. Our technologies facilitate processes and make them functionally safe. All this is complemented by diverse accessories such as lifting stations or caps and a wide range of impellers.

DRIVE TECHNOLOGY (see page 45):

Our motors are designed for diverse requirements making them highly flexible and versatile: ATEX-certified, IP68 waterproof, clean room-classified, stainless steel, ferrite-free.

CUSTOMISED SOLUTIONS

Not all requirements can be met by buying off the shelf or searching the internet. Especially in the fields of stirring and drive technology, no product resembles the other. This is why we offer innovative and customer-specific solutions to all customers with special requirements. We advise you in detail which certifications are necessary, which requirements must be met related to ATEX and occupational safety and regarding special conditions such as clean room classification, food-safety and protection class IP68.

OUR COMPETENCES:

- Development of pneumatic and electronic drive and agitator systems in our in-house development department
- Systematical project management
- Consulting by experienced experts
- Consulting with regards to occupational safety
- Broad know-how in special fields like ATEX, clean room, food hygiene, stainless steel, magnetically sensitive areas, IP68, GLP
- Process simulation and application tests
- Manufacture in in-house production (machining, rolling, grinding, assembly)
- Final assembling on site
- Comprehensive documentation
- After-sales service after termination of the project

EXAMPLES OF CUSTOMISED SOLUTIONS:

DRIVE TECHNOLOGY:

- Pneumatic drive of cleaning brushes for paint robots
- Machine drive for the production of explosive dynamite ignitors
- Sealing of bottles and glasses in automated lines
- Pneumatic drive of wheelchairs
- Emergency locking system in pipe systems
- Operation of blood pumps for babies to enable diagnosis in MRI devices

STIRRING TECHNOLOGY:

- Filling unit with integrated agitator
- Stirring of alcohol in 20 000 litres tank
- Special agitator for oleochemical industry
- Movable agitator for several containers
- Equipping of large paint supply rooms
- Stirring in IBC high racks

OUR USP, YOUR ADVANTAGE:



INNOVATION –
by our market experts



ACCURACY –
by our structured project management



INFORMATION –
by comprehensive documentation



FLEXIBILITY –
due to our in-house development and production



QUALITY PROMISE –
due to our in-house production



SUPPORT –
by our reliable after-sales service



UP
TO
90%
LESS
ENERGY



EFFICIENCY TEST at our customer Plakor

The company Plakor, internationally well-known supplier of visible plastic components in the interior and exterior of cars, replaced 120 vane motors by PTM stirring drives.

The situation:
120 agitators for 200l drums in continuous operation, speed approx. 100 rpm

The results:
Energy cost saving per year of 350 000€

EXTREME TEST at largest paint manufacturer in Germany

The situation:
Vane motor vs. PTM agitator motor
Test in 30l hobcock at idling speed, under full load and at standstill

The result:
Consumption at idling speed:
Vane motor: 250l/min.
PTM radial piston motor: 21l/min

Consumption under full load:
Vane motor: 200l/min.
PTM radial piston motor: 10l/min

Consumption at standstill:
Vane motor: 250l/min
PTM radial piston motor: 0l/min



The radial piston motor is the best the market of pneumatic drives has to offer. A high-quality, energy-efficient and cost-saving product. Definitely no better option out there.



József Cseh
Exclusive supplier of Robert Bosch and Suzuki Conpart Ker. és Szolg. Kft.



Vane motors seem to be cheaper when only considering their purchase price. This still steers some companies in the wrong direction. With a simple amortisation calculation we demonstrated that, after only one year of operation, the radial piston motor is more economic solely due to energy cost savings.



Vratislav Šrám
Exclusive supplier of Hyundai and Hella LPW kovo s.r.o.

ENERGY-EFFICIENCY

Our pneumatic agitators and compressed air motors are highly effective products. Every bit of the energy used is transformed into maximum power. Our drives need up to 90% less energy compared to other systems, for example the vane motor. This is why our drives are the pioneering technology for the future.

The technology of our motors is based on the radial piston principle. Compressed air is pressed into the small cylinders of the pistons. The air expansion inside the cylinders presses the pistons outward. The pistons roll along the wave-like housing wall and thus generate

the rotation movement. This process only needs as much air as can fit into the small cylinders of the pistons. At standstill, the motor consequently does not consume any compressed air at all.

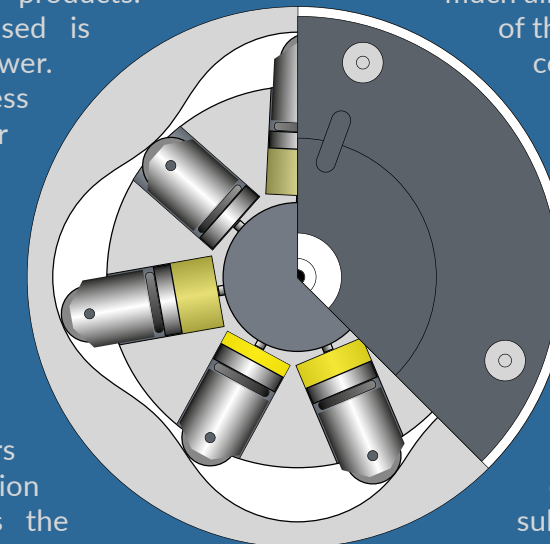

Do you know how much energy your system consumes?

We can gladly visit you on site to check your energy consumption. With facts and figures we realistically and reliably verify your possible energy savings. We are happy to subsequently advise you on how to save energy and money - of course without commitment from your side.

INDUSTRIES



CHEMICALS	12
FOOD	14
PHARMA	16
COSMETIC	18
AUTOMATION	20

TECHNOLOGIES



ATEX-CERTIFIED BY TÜV SÜD

Zone 1: II 2 G Ex h IIC T5 Gb X / II 2 D Ex h IIIC T100°C Db X;
Zone separation for zone 0/1: Ex II 1/2 G Ex h IIC T6 Ga/Gb X, Ex II 1/2 D Ex h IIIC T85°C Da/Db X.



RESISTANT TO CHEMICALS AND ACIDS

for the application with aggressive substances such as acetone.



OIL- AND SILICONE-FREE

to avoid contamination.



COMPRESSED AIR DRIVES
>> see pages 45 ff.



LABORATORY AGITATOR
>> see pages 38 / 39



AGITATOR DRIVES,
DRUM AND
IBC CONTAINER
AGITATORS
>> see pages 23 ff.
STAINLESS-STEEL AGITATORS
>> see pages 34 / 35

CHEMICAL INDUSTRY

The chemical industry is one of the most important industries in Germany. Its products can be found in numerous products from detergents through LED lights to smartphones.

Processes in the chemical and laboratory industry often involve the existence of special environments, for example due to the development of explosive atmospheres or the special requirements which often are obligatory in laboratories.

As technology supplier, it is important for us to know all these special circumstances and to include them in all our considerations with regard to product and project requirements. We therefore focus on your individual situation and support you in achieving optimum results. If necessary, all relevant certifications of approved testing facilities build the basis for your occupational safety procedures.

PTM mechatronics has a quality management system for the manufacturing of ATEX products according to ISO/IEC 80079-34:2018-08. For our stirring technology as well as our drive technology we have all necessary certifications up to ATEX zone separation 0/1.

For laboratories, we offer our ATEX-certified laboratory agitator eco-Lab with its broad accessory range.

Our drives and agitators are approved for the highest clean room class ISO 1 according to DIN 14644.

eco-Inox, our stainless-steel stirring and drive technology, is highly resistant to aggressive substances such as detergents, sterilisable with hydrogen peroxide, IP68 waterproof and ATEX-certified.



CASE STUDY
For the stirring of highly viscous substances used for the coating of wind turbines, Piper replaced vane by PTM radial piston motors.



CASE STUDY
Stirring of highly viscous substances in containers of different sizes with customer-specific filling concept.

TECHNOLOGIES



STAINLESS STEEL
sterilisable, robust, resistant to acids and chemicals.



FOOD-SAFE SEALING CONCEPTS
for hygienic applications.



CLEAN ROOM
classified for clean room class ISO 1 according to DIN 14644.



STAINLESS-STEEL MOTORS
>> see page 50



STAINLESS-STEEL AGITATORS
>> see pages 34 / 35



AGITATOR DRIVES,
DRUM AGITATORS
AND IBC CONTAINER
AGITATORS
>> see pages 23 ff.

FOOD INDUSTRY

In the food and beverage industry, hygiene is the paramount. The industry has to meet the highest requirements with regard to cleanliness and a hygienic work environment, purity of food components and compliance with legal food standards. Processes must therefore be fast, easy and secure.

For us, as technology supplier, and our products, the selection of suitable materials is very important. Many processes require the resistance against aggressive substances, such as detergents or hydrogen peroxide, or against acids. We minimise corners in which dirt could be collected, which makes cleaning much easier. Additionally, our products are IP67/68 waterproof.

To meet the high hygienic requirements, we offer our energy-efficient stirring technology eco-Series completely made of high-quality stainless steel: extremely resistant, waterproof, ATEX-certified. Also our compressed air drives are available in a stainless steel version.

For clean rooms, our agitators and drives are classified for the highest clean room class ISO 1 according to DIN 14644 and guarantee a particle-free operation.

4th GENE

CASE STUDY
*Stirring of aromas
with stainless-steel agitators
and TriClamp connections
for unlimited flexibility.*

TECHNOLOGIES



ATEX-CERTIFIED BY TÜV SÜD
 Zone 1: II 2 G Ex h IIC T5 Gb X / II 2 D Ex h IIIC T100°C Db X;
 Zone separation for zone 0/1: Ex II 1/2 G Ex h IIC T6 Ga/Gb X, Ex II 1/2 D Ex h IIIC T85°C Da/Db X.



FERRITE-FREE/FREE OF MAGNETIC FIELDS
 made exclusively from non-magnetic materials for magnetically sensitive applications.



CLEAN ROOM
 classified for clean room class ISO 1 according to DIN 14644.



STAINLESS-STEEL MOTORS
 >> see page 50



FERRITE-FREE MOTORS
 >> see page 51



LABORATORY AGITATOR
 >> see pages 38 / 39



STAINLESS-STEEL AGITATORS
 >> see pages 34 / 35

PHARMA INDUSTRY

Companies in the pharmaceutical industry undergo strict guidelines, for example the GLP (good laboratory practice) with regard to their quality management system. High quality and purity of their products is of vital importance. Research plays a major role compared to other industries. Special environments, such as clean rooms and laboratories are rather common. We consider your application as a whole and are oriented towards your optimum result. Additionally, we gladly advise you on extra topics like comfortable handling or facilitating of work processes.

Both, our stirring technology eco-Series and our drive technology, are classified for the highest clean room class ISO 1 according to DIN 14644. All our products are also available in a stainless-steel version – hygienic and resistant to acids and chemicals.

Thanks to our in-house development department, we are able to offer our agitators in special versions which are typically needed in the pharmaceutical industry, for example with TriClamp or DN flange.

Especially designed for laboratories, our ATEX-certified laboratory agitator eco-Lab with its accessories guarantees secure and easy handling with reliable results.

For applications that react sensitively to magnetic fields, such as MRI applications, our ferrite-free motor provides a drive without magnetic fields or disturbing sensors and electronics.

ETH zürich

CASE STUDY
Ferrite-free motor for the drive of blood pumps for babies to enable diagnosis with MRI devices.

TECHNOLOGIES



ATEX-CERTIFIED BY TÜV SÜD

Zone 1: II 2 G Ex h IIC T5 Gb X / II 2 D Ex h IIIC T100°C Db X;
Zone separation for zone 0/1: Ex II 1/2 G Ex h IIC T6 Ga/Gb X, Ex II 1/2 D Ex h IIIC T85°C Da/Db X.



STAINLESS STEEL

sterilisable, robust, resistant to chemicals and acids.



CLEAN ROOM

classified for clean room class ISO 1 according to DIN 14644.



STAINLESS-STEEL MOTORS

>> see page 50



LABORATORY AGITATOR

>> see pages 38 / 39



STAINLESS-STEEL AGITATORS

>> see pages 34 / 35

COSMETICS

For the production of cosmetic products, no matter if care products or decorative cosmetics, stability during the production process and clean and gentle processing play a major role. The process involves the development of the substances in the laboratory, production, filling of bottles, jars, tubes or pump dispensers and labelling. In each of these processing steps, the products of PTM mechatronics are in use. Additionally, our engineers gladly inspire you with innovative ideas in regard to your individual requirements.

Especially for the laboratory, we developed our ATEX-certified agitator eco-Lab. Combined with its accessory portfolio, it is immediately operable and stirs liquid, creamy or powdery substances of any viscosity and density gently and evenly.

For the production, we developed our high-torque industrial agitators which stir liquid substances as well as substances with high density and viscosity. The eco-Series is ATEX-certified and applicable in explosive areas up to ATEX zone 0/1. The eco-Series is also available completely made of high-quality stainless steel, the eco-Inox series.

In the field of drive technology, for example the drive of conveyor belts or the closing of screw caps, we offer our drives in a stainless-steel version, IP68 waterproof and ATEX-certified.

PURE GREEN

CASE STUDY

IBC agitator solutions for the stirring of cosmetic raw materials used for certified natural cosmetics in high racks.

TECHNOLOGIES



ATEX-CERTIFIED BY TÜV SÜD

Zone 1: II 2 G Ex h IIC T5 Gb X / II 2 D Ex h IIIC T100°C Db X;
Zone separation for zone 0/1: Ex II 1/2 G Ex h IIC T6 Ga/Gb X, Ex II 1/2 D Ex h IIIC T85°C Da/Db X.



STAINLESS STEEL

sterilisable, robust, resistant to acids and chemicals.



CLEAN ROOM

classified for clean room class ISO 1 according to DIN 14644.



IP68 WATERPROOF

for applications with water and underwater.



COMPRESSED AIR MOTORS

>> see pages 45 ff.

AUTOMATION

To the automation industry belong suppliers of machines and systems who provide process automation. Their products can be found in all industries that need or wish to have a certain automation degree, for example to make processes easier, faster, more secure, more regular and reliable or cheaper.

PTM mechatronics has its roots in the automation technology. Numerous projects in mechanical engineering and automation technology make us your reliable and professional partner when it comes to individual requirements with regard to machines and systems of the drive technology. Our approach is to consider your individual requirements as a whole and from different perspectives in order to find your optimum solution. We are your idea provider, consultant, developer, manufacturer and installer – all under one roof.

A selection of projects at a glance:

- Drive of friction wheels on balance systems
- Rotary drives and tables
- Drive of conveyor belts
- Automated sealing of screw caps
- Automated opening and closing of rolling gates of all kinds
- Controlling of actuators in safety systems
- Drive of cleaning brushes
- Drive of linear axes

Agitators in their most efficient form

The stirring process is a core process in many industries. Be it to mix substances, to maintain a specific physical state, for heat transfer, among many other uses. Which stirring process is appropriate for my application? Which impeller provides the best performance with regard to the intended result and the respective substance? Which special criteria must be taken into consideration?

For many years, the PTM mechatronics team has been dealing with the intricacies of stirring processes of all kinds in many different industries, mainly the food, pharma, chemical, cosmetic and automation industries. The sensitivities and requirements related therewith, for example hygiene regulations, ATEX safety or clean room capability, form the frame of our project work and our products.

The eco-Series, with its functional and efficient product portfolio, combined with the development competence of the PTM engineers provide solutions for the most requirements possible, while always keeping pace with the latest trends. Our portfolio includes drives with various flange solutions, complete agitators with equipment up to the construction of whole stirring systems with interconnected control. All eco-Series products are ATEX-certified and are applicable in ATEX zone 0/1.

The eco-Series comprises only highly efficient products. All drives and agitators consume a minimum of energy while generating the maximum power - without any transmission.

STIRRING TECHNOLOGY



System agitators

Do you already have a stirring container like a tank, vessel or reactor and only need the fitting agitator, possibly a fitting flange?

Then our system agitators are the right choice for you. Depending on your application and your already existing equipment, we complete your system with the fitting agitator regarding performance and dimensioning.

Our agitators are fixed via the PTM bore pattern either directly to the cap or to standard flanges like **DN flange, TriClamp, threaded connectors or dairy pipe connections**. For open containers we additionally equip your agitator with a fitting cap made of high-quality stainless steel.

Our agitators are **ATEX-certified for zone 1 and, with zone separation flange, for zone 0/1** and thus are applicable in all explosive areas. We also offer a special sealing concept for **overpressure and negative pressure applications**. Thanks to our in-house production, we are able to flexibly manufacture your agitator according to your individual needs. Our experts will gladly advise you.

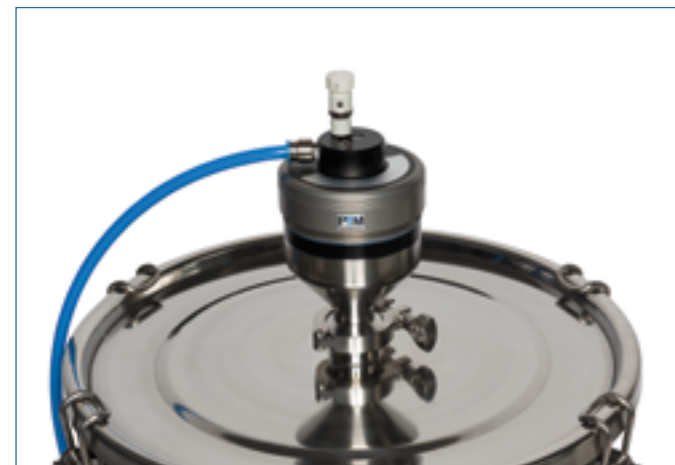

eco-Drive with DN flange

eco-Drive with TriClamp



DRIVES	Torque	Air consumption at 100 rpm and average power	Diameter
eco 450	4 Nm	25 l/min	99 mm
eco 900	8 Nm	50 l/min	99 mm
eco 1800	16 Nm	100 l/min	159 mm
eco 3600	32 Nm	200 l/min	159 mm

ECO

builds the basis of all drives of our eco-Series, for applications in ATEX zone 1 with already existing flange solutions.

ECO-SEAL

provides zone separation between ATEX zone 0 and 1 with integrated sealing concept for overpressure and negative pressure.

ECO-DRIVE

designed for the application in explosive areas of ATEX zone 1 and equipped with bearing flange.

ECO-TOPDRIVE

designed for the application in explosive areas of ATEX zone 0/1 with zone separation.

eco-Drive
for ATEX zone 1



eco-TopDrive
for ATEX
zone separation 0/1



eco-Seal
for ATEX
zone separation 0/1
with gasket for
overpressure and
negative pressure



Drum agitators

Are you in search of a suitable agitator for your individual requirements such as viscosity of the mixed substance, size of the stirring container or compliance with special occupational safety characteristics? Then our drum agitators are the right choice for you.

Designed for the most common container sizes, our standard agitators facilitate the selection of the right agitator. You can see at one glance which agitator is suitable for your steel drums, plastic drums or hobocons. Just select the suitable drive from our four performance classes and the correct dimensioning for the agitator shaft and impeller depending on your container size.

By means of our **broad accessory portfolio** with lifting stations, stainless-steel caps, traverses, impellers, etc., we set up your agitator according to your specifications.

Our agitators are ATEX-certified for **ATEX zone 1** (eco-Drive) and with zone separation for **ATEX zone 0/1** (eco-TopDrive) and can be operated in all explosive areas. Equipped with an additional gasket (eco-Seal), our agitators can also be applied in **overpressure or negative pressure applications**. All of our agitators are exceptionally easy to handle and operable immediately. They are controlled easily by a stepless speed setting.

Additionally, we also meet individual requirements with regard to dimensioning and performance. You can set up your customer-specific system with us, from one single agitator up to complete systems consisting of various stirring stations including accessories and implementation. Our experts will gladly advise you regarding the dimensioning of your system and suitable accessories.

Of course, all our products comply with **occupational safety requirements**.

DRIVES	Torque	Air consumption at 100 rpm and average power	Diameter
450	4 Nm	25 l/min	105 mm
900	8 Nm	50 l/min	105 mm
1800	16 Nm	100 l/min	169 mm
3600	32 Nm	200 l/min	169 mm

STANDARD DIMENSIONS stirring container	LENGTH AGITATOR SHAFT from top edge cap	IMPELLER eco-Cup
30 liter HOBBOCK	360 mm	Ø 170 mm
60 liter HOBBOCK	535 mm	Ø 210 mm
100 liter DRUM	740 mm	Ø 260 mm
200 liter DRUM	775 mm	Ø 320 mm

eco-Traverse

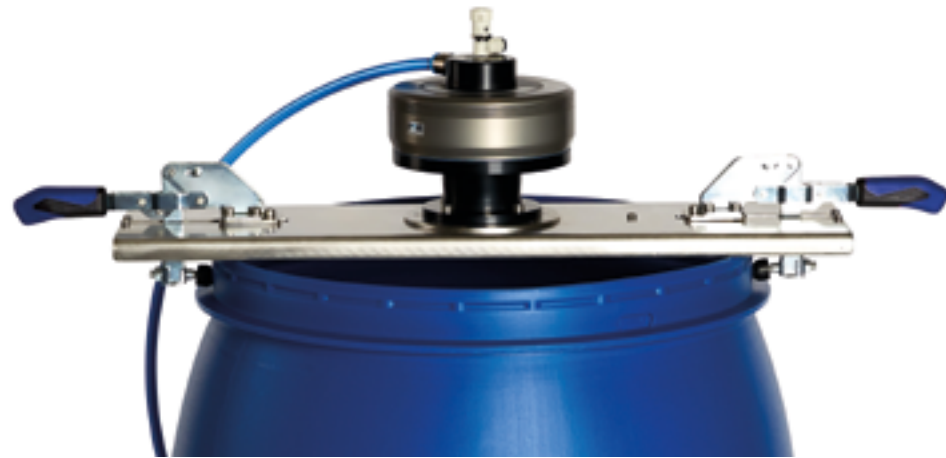

Our eco-Traverse is especially designed for an easy and quick mounting of agitators on all common stirring containers. It is made of **high-quality stainless steel** and therefore **resistant to aggressive substances** which makes its **cleaning very easy** and guarantees safe handling of all kinds of substances.

The eco-Traverse is available in two sizes, each additionally adjustable to slightly varying container sizes. Due to its easy handling, the mounting and removing process can be conducted by just one person.



Suitable for metal and plastic drums



Inclined traverse suitable for 2" tight-headed drums

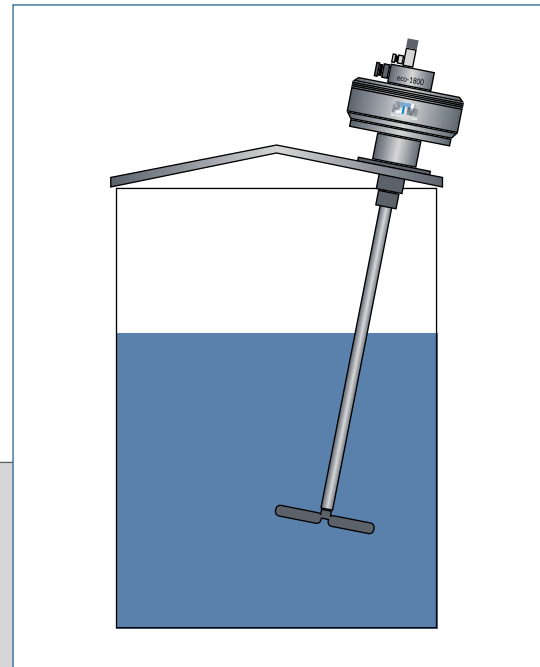

ECO-TRAVERSE

eco-Traverse 500

eco-Traverse 600

Inner diameter drum

300-490 mm

460-640 mm

Drum agitators Accessories



eco-Cap

Our eco-Cap, made of **high-quality stainless steel**, is standardly available in three different versions for three different container sizes, each available as **plain cap** or **with circumferential edge**. Of course, we also adapt our eco-Cap to your individual requirements with regard to size and equipment.

To comply with possible occupational safety regulations, a **safety grid** can be attached to the hatch. The **optional safety switch-off** eco-Stop switches off the agitator as soon as the hatch is opened.



eco-Cap with 1/4 hatch



eco-Cap with two 1/4 hatches



eco-Cap with eco-Stop



eco-Cap with safety grid

CAPS

eco-Cap 10

eco-Cap 30

eco-Cap 200

Inner diameter drum

262-286 mm

310-370 mm

460-600 mm

Hatch

NONE

ONE 1/4

TWO 1/4

OCCUPATIONAL SAFETY – AN EXCURSUS

„Occupational safety measures within the meaning of this act are measures for the prevention of accidents at work and work-related health risks including measures for humane working conditions...“. That is the translated definition of the German Federal Office. Occupational safety these days plays an even more important role. Industries

take all necessary steps to guarantee the safety of their employees. Due to our practical experience, we know what is important with regard to our products and the occupational safety they have to provide. We thus are able to reliably assist our customers in taking the necessary measures. We develop our products observing the following aspects:

AVOIDANCE OF

- injuries caused by touching of moveable parts or bruising,
- sparks or explosions,
- unintended contact with substances, for example due to splashes in the eyes.

OBSERVING OF

- MAK-values at work
- maximum noise emission values
- maximum energy values for environmental care
- technical rules for hazardous substances TRGS27

EU-conformity Machinery Directive 2006/42/EG • EU-conformity ATEX manufacturer's guideline 2014/34/EU
Observing of DGUV safety requirements for tripod and suspended agitators



Stirring stations



Cap with safety grid



- As standing version or wall-mounted
- Control panel with two-hand control and emergency stop
- Switch-off for agitator when cap is lifted
- Moveable and equipped with drum trolleys optional

With the stirring station eco-Station containers can be exchanged easily and cleanly by just one person without any exertion by means of an automatic system. As the station and the permanently fixed agitator move up and down in a straight vertical direction, smudges around the station are avoided.

ATEX-certified, the eco-Station is applicable in explosive areas of ATEX zone 1 and, with zone separation, of ATEX zone 0/1. As an additional safety measure, the **safety switch-off eco-Stop** switches off the agitator as soon as the cap is lifted. The **two-hand control eco-Two** prevents the operator from reaching into moving parts of the station with a free hand. Our stations comply with all **occupational safety requirements**.

Besides our three standard sizes, we are happy to design stirring stations according to your **individual requirements** with regard to dimensioning and performance. We offer stirring stations for IBC containers/ tote tanks as well.

STANDARD SIZES	For standard containers	Lifting height	W / H / D
eco-Station 30	30 - 60 l	500 mm	440 / 1335 / 600
eco-Station 200	100 - 200 l	1000 mm	700 / 2344 / 800
eco-Station IBC	600 - 1200 l	1200 mm	1200 / 1600 / 2600

IBC container agitators

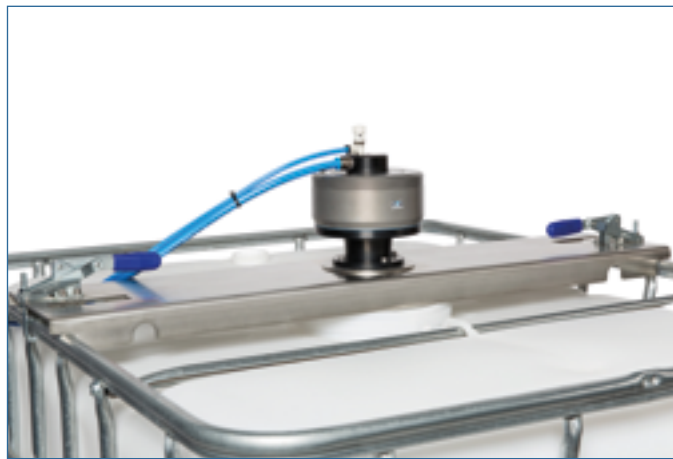

AGITATOR WITH TRAVERSE

Our eco-Traversal IBC is especially designed for an easy and quick mounting of agitators on IBC containers of all sizes. It provides a solid construction for the stirring of all, also highly viscous, substances. The high-quality traverse is completely made of stainless steel and is thus resistant to aggressive substances.

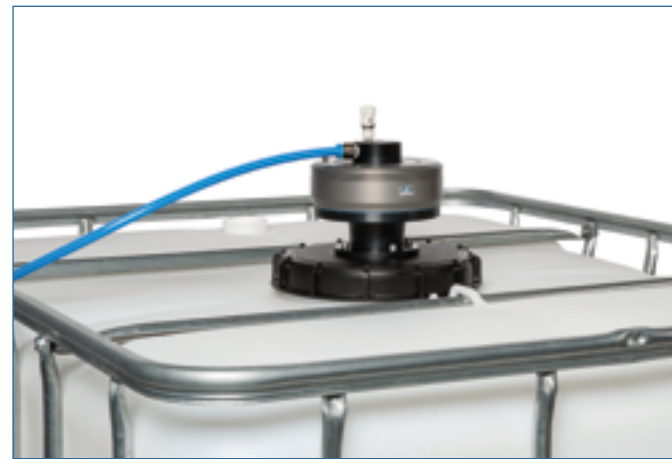

AGITATOR WITH ECO-LIGHT

Our system eco-Light is fixed directly to the container opening. Further fixing components are not needed. The agitator can be removed by just one person. The system is particularly suitable for the easy handling of substances of low viscosity.



FOLDABLE IMPELLERS

Many impellers are available in a foldable version to be able to insert them uncomplicatedly into the tank.



Are you in search of a suitable agitator for your IBC container and your individual specifications such as viscosity of substances or special **occupational safety requirements**?

Then our IBC container agitators are the right choice for you. We develop your customer-specific system with individual agitator shafts and impellers made of high-quality stainless steel or, for the stirring of chlorides, made of plastic. Our agitators are fixed either with our screw fastening eco-Light directly to the container opening or with our handy stainless-steel traverse.

Our systems can be **handled by just one person**. Their weight is appropriately low and their handling easy. They are operable immediately without any installation work. Our agitators, ATEX-certified for **ATEX zone 1 and, with zone separation, for ATEX zone 0/1**, are safely applicable in all explosive areas. A step-less speed setting precisely controls the operating speed.

Our portfolio comprises single agitators up to whole systems of various stirring stations including accessories and implementation. Our experts will gladly advise you with regard to dimensioning of the system, flange solutions and suitable accessory. Of course, our systems comply with all occupational safety requirements.



HYGIENIC
with FDA-compliant gaskets, sterilisable with hydrogen peroxide and oil- as well as silicone-free, the optimum for applications in areas with the highest hygiene demands.



CLEAN ROOM
classified for the highest clean room class 1 according to DIN 14644 and thus unrestrictedly applicable in all clean rooms.



IP68 WATERPROOF
and thus applicable in applications with water and underwater, mainly ideal for easy and safe cleaning.



ACID-/CHEMICAL-RESISTANT
and thus highly resistant to aggressive media for the unrestricted application with substances of all kinds and easy to clean.



ATEX-CERTIFIED
for the absolutely safe application in all explosive areas of zone 0/1.



Stainless-steel agitators



In many industries product processing underlies special standards either with regard to hygiene or safety. Whether food, pharma, cosmetic or the chemical industry, there are requirements in each of these industries such as food-safety, high resistance against aggressive substances or sterilisability.

As experts for these industries and their characteristics, we offer all of our products in **high-quality V4A stainless steel 1.4404** - the eco-Inox series with its versatile features for a **hygienic, safe and easy application** in all fields.

For flawless, hygienic surfaces, the steel is **rolled or electropolished**. Our in-house production has many years of experience in these kinds of manufacturing processes. We achieve a roughness depth between 0,1 and 0,35 µm.

As an option, we equip the agitators with **FDA-compliant gaskets** in order to meet possible food-safety requirements.

To simplify cleaning and avoid additional corners in which dust may collect, the common glued labels can be substituted by **laser engraving**.

Please let us know if you wish to have your agitator manufactured of other materials, as for example **stainless steel 1.4435 or 1.4571**.

Hand-held agitator



HELICAL RIBBON IMPELLER
with upward or downward
mixing motion optionally

- ATEX-CERTIFIED
- ERGONOMIC HANDLE
- STEPLESS SPEED SETTING
- HIGH TORQUE
- SAFE TWO-HAND OPERATION



Our hand-held agitator eco-Up allows an ergonomic and safe stirring of substances of all kinds. Despite important safety precautions, which the agitator is equipped with to make its operation completely safe, its handling is easy and comfortable due to its special features:

eco-Up is ATEX-certified for **ATEX zone 1** and operable in explosive areas. It is equipped with an **ergonomic handle** for both hands that allows the stable standing of the operator during operation and simultaneously facilitates its safe lifting. Substances of all kinds, be it liquid or highly viscous, can be stirred with powerful movements.

Its **two-hand operation** avoids accidents. As soon as one hand releases the handle, the agitator is automatically switched off. eco-Up is equipped with a **stepless speed control**. Due to its **high torque** it is capable of stirring initially highly viscous substances easily. For comfortable storage after work, a **functional hanging system** can be ordered optionally.

ECO-UP	Torque	Air consumption at 100 rpm and average power	Speed
eco-Up 450	4 Nm	25 l/min	0 - 300 1/min
eco-Up 900 G	4 Nm	50 l/min	0 - 600 1/min

Laboratory agitator eco-Lab



WITH STAND,
AGITATOR SHAFT AND
IMPELLER OPTIONALLY



The ATEX laboratory agitator eco-Lab is equipped with the energy-efficient agitator drive eco, **quick-action chuck** and **mounting bar**. It is easily integrated in each application, for example reactors or condensers. Combined with its accessory, you get a complete and immediately operable device.

With its ATEX certification for **ATEX zone 1**, it is applicable in explosive areas. Due to its low speed but **high torque**, it reliably and steadily stirs all kinds of substances, be it liquid or highly viscous. The agitator has a stepless speed control. Supply and exhaust air are attached comfortably to the integrated connector block.



EXEMPLARY APPLICATIONS

Agitators on reactors, condensers or stands
Laboratory, quality tests, development,
testing procedures
Pharmacy, medical technology,
food production
Chemical process vessels
Processing of paints, lacquers,
adhesives, fillers and sealants

AGITATORS	Torque	Air consumption at 100 rpm and average power	Speed
eco-Lab 450	4 Nm	25 l/min	0 - 300 1/min
eco-Lab 450 G	2 Nm	25 l/min	0 - 600 1/min

Impellers

The selection of the suitable impeller type is decisive for the optimal mixing result. Depending on the viscosity of the mixed substance and the mixing task (homogenisation, suspending, dispersing, etc.) one impeller might have more suitable characteristics than others. Besides our product portfolio, we will gladly advise you which impeller is the best for your application. Of course, we are able to develop your customer-specific solution according to your needs.



HOLLOW-BODY IMPELLERS

The impellers eco-Cup and eco-Disc provide an efficient mix even with low speed, also with solid materials or fibres, and thus are low-speed impellers.



PROPELLER

The propeller is a quick axial mixer with turbulent mixing characteristic. It is particularly suitable for homogenisation, suspending, dispersing and circulation.



DISSOLVER DISC

The dissolver disc is mainly used for the dispersion process, i.e. the mixing of at least two substances. It is, for example, particularly suitable for the preparation of an oil-water-emulsion.



HELICAL RIBBON IMPELLER

The helical ribbon impeller is mainly a solid material impeller with an axial flow direction and laminar characteristic. It is particularly suitable for homogenisation and heat exchange.



PITCH BLADE TURBINE

The pitch blade turbine provides an axial and radial flow direction with turbulent mixing characteristic. It is particularly suitable for homogenisation, suspending, dispersing and circulation.

Simulation

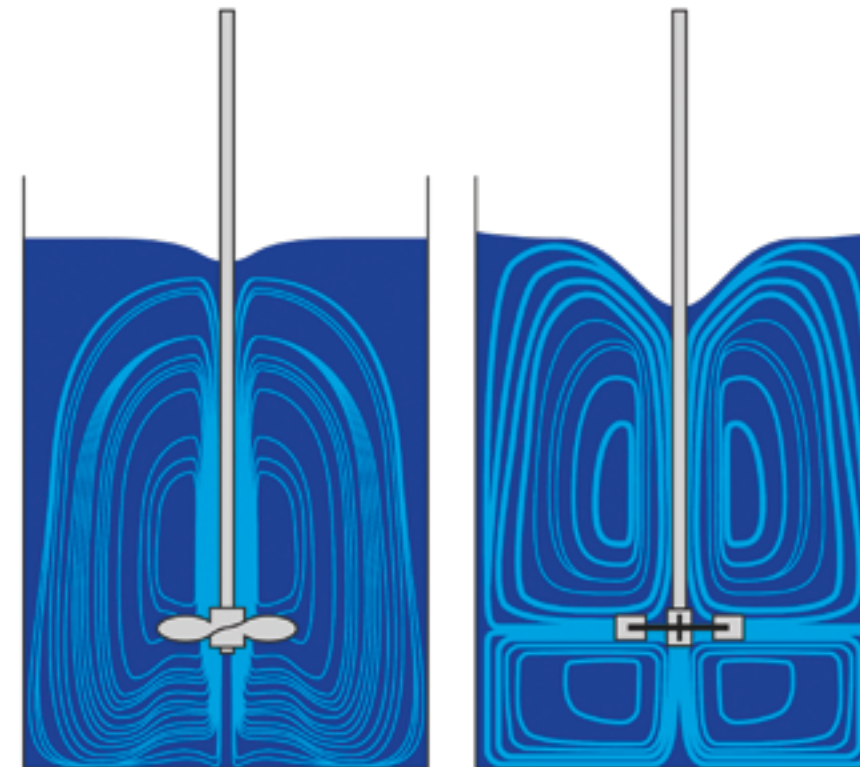

The stirring process is very complex. The challenge is to understand laminar and turbulent flows while including criteria such as the impeller used, viscosity and density of the substance mixed or the type of container.

To be able to give our customers a realistic recommendation for their application with regard to equipment required and the final mixing result, we use the computer-based flow simulation CFD (Computational Fluid Dynamics) for application tests. Based on the simulation, we are able to evaluate the appropriate drive with regard to its torque to make the application as energy-efficient as possible. The selection of the suitable impeller avoids unintended shear forces.

You can rely on us achieving the perfect results even when it comes to highly complex tasks (for example the mixing of two naturally not, or not readily, soluble substances). We gladly simulate your stirring task during the offer phase before starting the actual project.

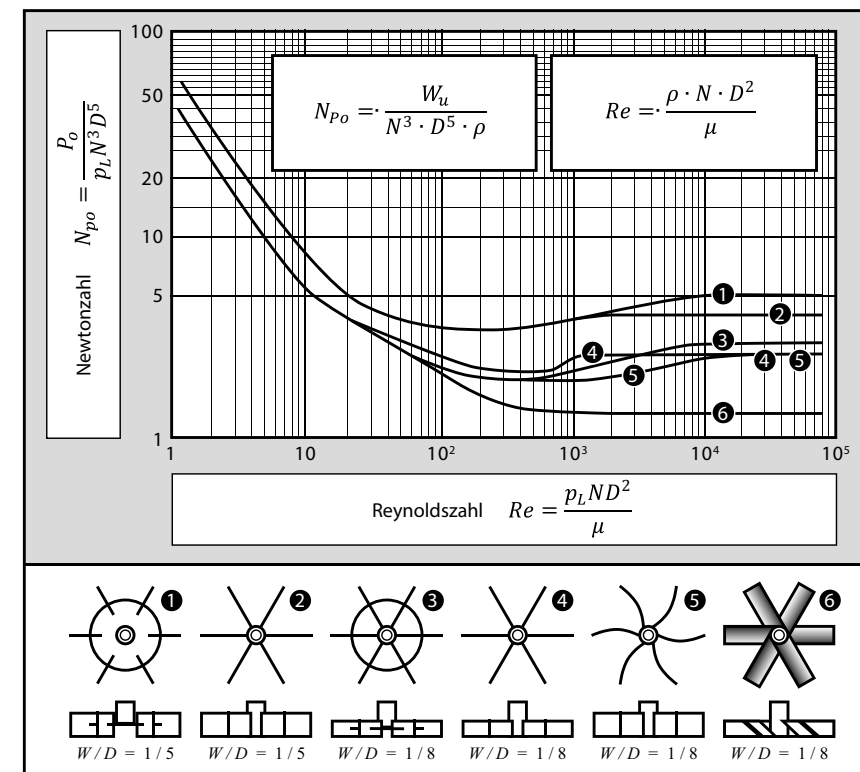

Suction lance eco-Twin

Our technology eco-Twin (ATEX zone separation 0/1) combines agitator shaft and suction lance in one component. For removal, the liquids are sucked out by means of a special construction inside the agitator shaft. The suction lance as an additional separate component inside the container is spared.

This has the following three important advantages:

First, after operation, only one component needs to be cleaned instead of two separate ones, **saving time and cumbersome processes.**

Second, sparing one component leaves **more space inside of the container.** This plays a major role in small containers with already little volume and in containers with more functions that all need sufficient space.

Third, and the most important point, eco-Twin makes processes much safer considered from the **ATEX safety** perspective. Each additional component inside a container increases the risk of collision between them. Uncontrolled sparking would be the consequence and the risk of an explosion. The combination of agitator shaft and suction lance minimises this danger.

eco-Twin is designed customer-specifically according to your individual requirements.

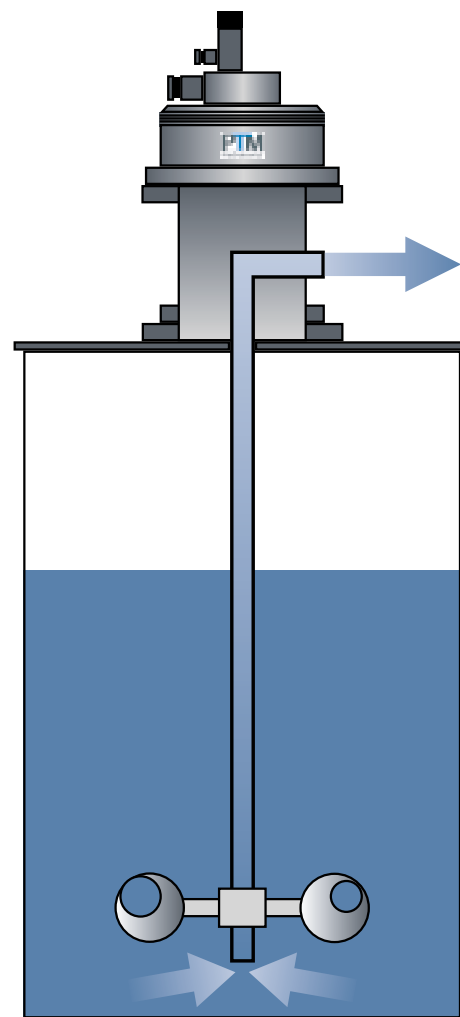

TECHNOLOGIES AGITATORS

Quick-change system eco-Quick

Our quick-change system eco-Quick reduces the effort of changing agitator shafts to a minimum. With just one hand, the agitator shaft is removed smoothly from the agitator and attached again - **without tools, without screws.** This system, suitable for all PTM agitators, makes the process **easy, clean and organised.**

The high-quality system is completely made of **stainless steel** and thus **highly robust** even against aggressive substances. A special gasket prevents the ingress of liquids into the system. The gasket is easily replaceable. The quick-change system is **durable, easy to maintain and easy to clean.**

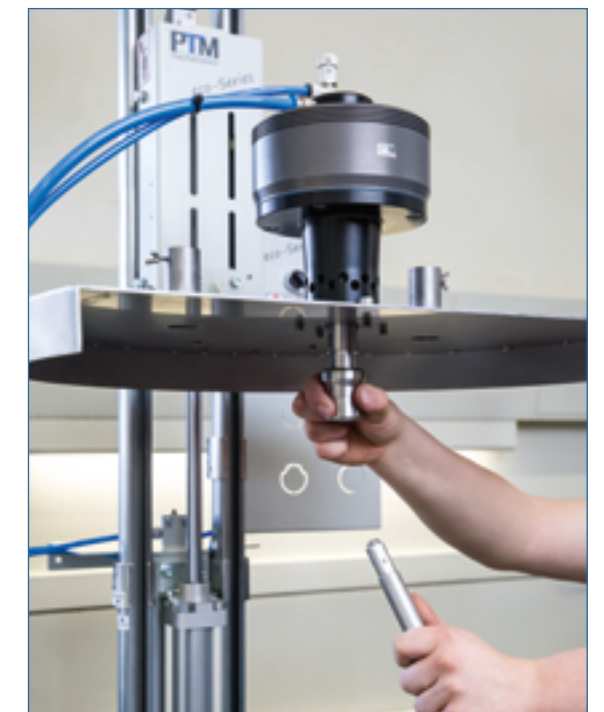
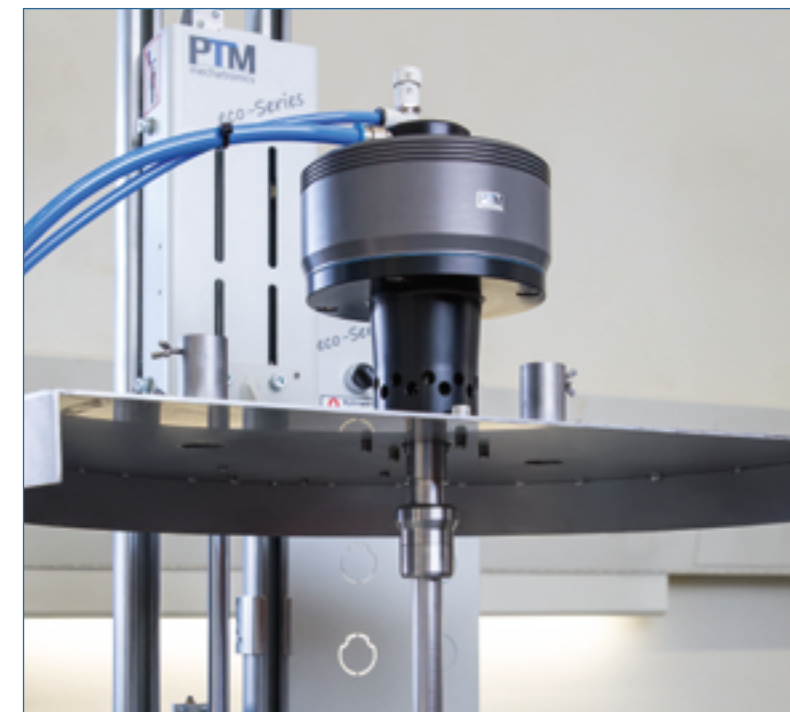

High-performance energy wonder

PTM compressed air motors are well known for their high-performance but still extremely efficient drive. In times of the energy revolution and sustainability, we have to economise on energy in general, also on compressed air.

The radial piston principle, that builds the basis of our motors, needs a minimum of compressed air to extract a maximum of power with an extremely high torque. Compared to other drive technologies our motors save up to 90% of compressed air and thus energy costs, making it the pioneering technology for the future.

The construction of our motors is purely mechanical, no electrics, no sensors. Their operation is thus extremely safe with regard to the application environment on the one hand. On the other hand, the motors are installed within a few minutes and immediately operable. You do not need any additional devices or a specialist such as an electronics technician.

Despite their high torque, PTM compressed air motors are small and compact. They are operable in clockwise as well as anti-clockwise rotation, resilient to standstill and waterproof according to protection class IP67. This means they are safely applicable in wet or dusty environments.

Each type of our motor has different characteristics. Their application spectrum ranges from the operation in medical technology devices and the control of waterpipes to the drive of production machines of dynamite ignitors in explosive atmospheres and the operation of conveyor belts in the food industry.

In all these projects, and many more, our engineers have developed completely new machines and systems in close cooperation with our customers. Please convince yourself of the versatility of our motors and the know-how of our engineers. We are curious about what we can do for you...

DRIVE TECHNOLOGY

BASIC Motor

FOR UNCOMPLICATED APPLICATIONS

EXEMPLARY APPLICATIONS

- Drive of friction wheels
- Drive of balance systems
- Drive of mining and construction machinery; processing of lime, gypsum, concrete, cement
- Drive of conveyor belts
- Sealing of screw caps
- Tension in paper, waving and winding machines



ACCESSORIES >> see pages 52 / 53

DATA	Torque	Air consumption at 100 rpm and average power	Diameter	Height
Motor 450	4 Nm	25 l/min	99 mm	50.5 mm
Motor 900	8 Nm	50 l/min	99 mm	65 mm
Motor 1800	16 Nm	100 l/min	159 mm	67.5 mm
Motor 3600	32 Nm	200 l/min	159 mm	89.5 mm

The data indicated above applies to **all** motor types.

The BASIC motor is suitable for simple applications without any special requirements. It is available optionally with three different sealing concepts:

- Viton gasket for high temperature and chemical resistance
- Acetone-resistant, solvent-resistant gasket
- Silicone-free gasket - for an oil-free application without releases

EFFICIENT



ROBUST



HIGH-PERFORMANCE



SILENT



ATEX motor

Certified by TÜV Süd with ATEX certificate II 2 G Ex h IIC T5 Gb X, II 2 D Ex h IIIC T100°C Db X, our ATEX motors are applicable in all explosive areas of ATEX zone 1. The purely mechanical construction avoids the development of heat or sparks during operation, which could inflame flammable substances such as alcohol, solvents or dusty or dust-producing substances. Furthermore, the motor does not need an additional electricity supply. (Technical data page 46)



-  ATEX-CERTIFIED
-  SILENT
-  HIGH-PERFORMANCE
-  EFFICIENT





EXEMPLARY APPLICATIONS

- Drive of conveyor belts
- Drive of machines in chemical plants
- Drive of mills and milling plants
- Drive of bulk material transport systems
- Drive of machines in explosive areas
- Drive of machines for the handling of explosive substances/components

IP68 waterproof motor

This motor is waterproof according to protection class IP68 even under extreme conditions. It can be operated permanently underwater and applied in dusty environments. This makes its cleaning very easy. It is seawater-resistant and withstands a water depth of up to 40 metres. (Technical data page 46)



- IP68 WATERPROOF 
- ROBUST 
- EFFICIENT 
- HIGH-PERFORMANCE 

EXEMPLARY APPLICATIONS

- Drive of machines in humid or wet environments
- Drive of brushes and belts in washing facilities
- Drive of rotary axes and brushes in cleaning systems
- Drive of submersibles
- Automatic closing mechanism in pipe systems
- Drive in humidification systems
- Drive in filling plants and lines

Stainless-steel motor

The stainless-steel motor is the all-rounder of our motor product portfolio. Its high resistance against acids and chemicals makes it extremely robust even when used with aggressive substances, for example for cleaning or for sterilisation with hydrogen peroxide for hygienic applications. As it is waterproof according to protection class IP68, it can be operated underwater or in wet or dusty environments. It is classified with clean room class ISO 1 according to DIN 14644 and thus is applicable in all clean rooms. ATEX-certified by TÜV Süd with certificate II 2 G Ex h IIC T5 Gb X / II 2 D Ex h IIIC T100°C Db X, it is operable safely in all explosive areas of ATEX zone 1. (Technical data page 46)



-  ATEX-CERTIFIED
-  HYGIENIC
-  IP68 WATERPROOF
-  CLEAN ROOM CLASSIFIED

EXEMPLARY APPLICATIONS

- Drive in clean rooms
- Drive of conveyor belts
- Drive of packaging machines
- Drive of brushes and belts in washing facilities
- Drive of rotary axes and brushes in cleaning systems
- Drive of submersibles
- Automatic closure mechanism in pipe systems
- Drive in humidification systems
- Drive in filling plants and lines, breweries
- Drive in the milk collection technology
- Drive of bakery and pastry machines
- Drive of machines in chemical plants
- Drive of mills and milling plants



Ferrite-free motor

Ferrite is a mixed crystal of ferric and a small proportion of carbon. It becomes magnetic under the influence of magnetic fields. That is why it is not suitable for applications which produce magnetic fields and, additionally, are influenced negatively by other magnetic fields. We therefore exclusively use non-magnetic materials such as ceramics. Additionally, the mechanical construction of our motors avoids potential interferences that may be caused by electronics or sensors. The ferrite-free drive is applicable in sensitive applications with magnetic fields such as MRI devices. (Technical data page 46)

WITHOUT MAGNETIC FIELDS



HIGH ELECTROMAGNETIC COMPATIBILITY



NO INTERFERENCE POTENTIALITY



LONG-TERM EXPERTISE

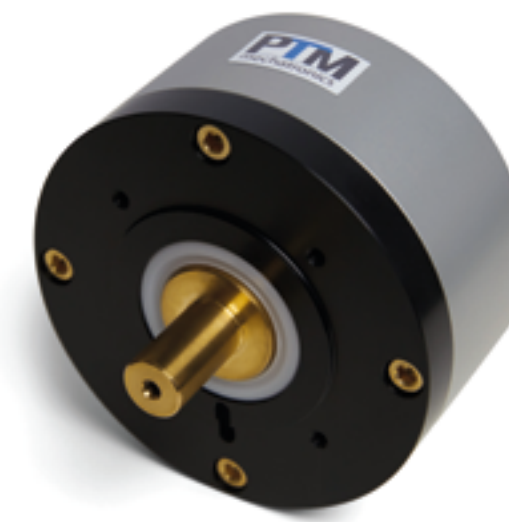

EXEMPLARY APPLICATIONS

- Medical technology
- MRI devices
- Mine detectors
- High frequency applications
- TESLA applications
- Conveyor belts or drives for the production of sensors



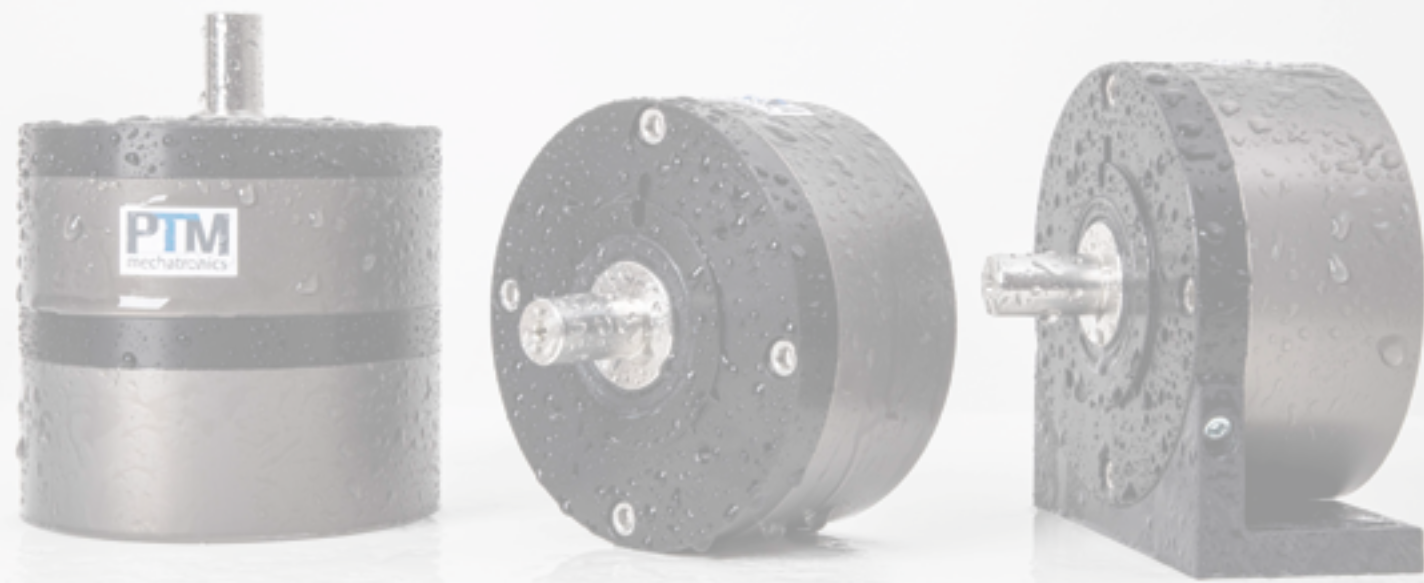

Accessory motors

AIR CONNECTION WITH 90° ANGLE



TRANSMISSION



VARIOUS SHAFT SEALS:

- **Viton** – for high temperature and chemical resistance
- **Acetone-resistant** – made of solvent-resistant EPDM for a long product durability
- **Silicone-free** – oil-free application without releases
- **FDA-conform** – made of EPDM with FDA approval for a hygienic application in food & pharma



BEARING FLANGE



MOUNTING FLANGE



MOUNTING ANGLE

SHAFT WITH FEATHER KEY IN VARIOUS DIAMETERS



SHAFT SMOOTH IN VARIOUS DIAMETERS



REV COUNTER



MAINTENANCE UNIT FOR SUPPLY AIR TREATMENT



SUSTAINABILITY & ENVIRONMENT

EDUCATION

We care for the education of the next generation by yearly training places.



ENERGY BALANCE

According to energy audit EN16247-1 our company's energy values are significantly lower than the average of our industry.



EFFICIENCY

Our compressed air motors consume little energy while providing the maximum power.



EMPLOYEES

Together we create a positive work environment with respect and equality.



SAFETY

We secure our future by regular certification audits and sound planning.



NOTES



Drive and stirring technology for
FOOD | PHARMACEUTICALS | CHEMICALS | COSMETICS | AUTOMATION

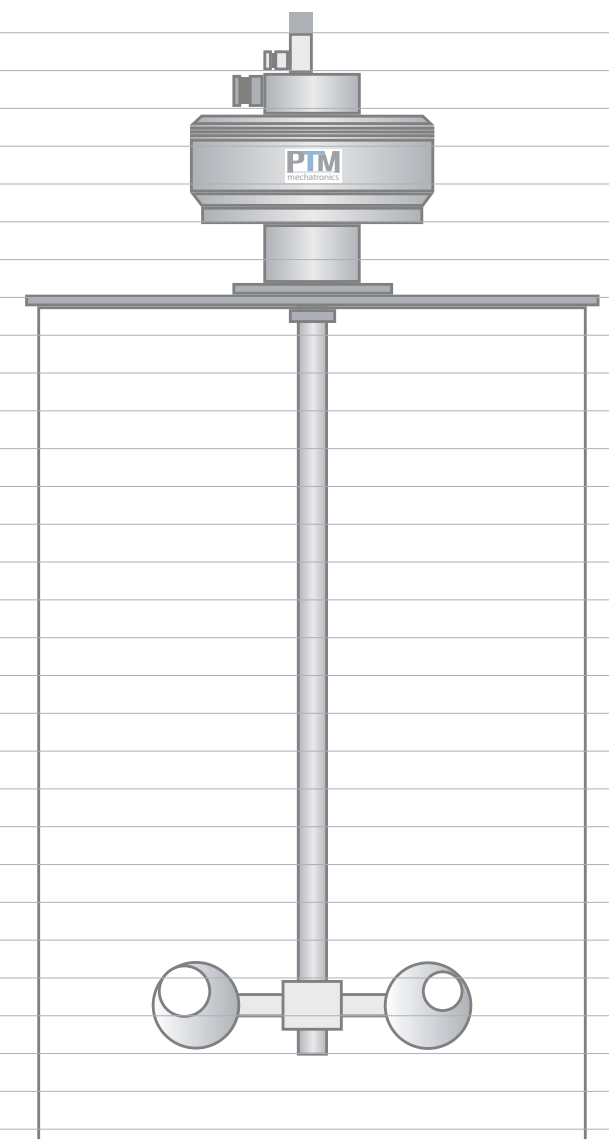

PTM mechatronics GmbH

Gewerbepark 1 | 82281 Egenhofen | Germany

Phone +49 8134 25 797 0 | Fax +49 8134 25 797 99

info@ptm-mechatronics.com | www.ptm-mechatronics.com

