



Solutions for Marine Industry



The WEG Group

WEG is a globally-accepted supplier of Premium electric products for the industry. Counting on more than 27,000 employees all over the world and a daily production of 60,000 motors, WEG became the leading electric motor manufacturer in the Americas and one of the largest suppliers of electric and electronic products and systems in the world. With exports to over 135 countries and revenues exceeding US\$ 3 billion, WEG global presence is supported through its branches established in 27 countries, manufacturing facilities and a network of distributors and representatives in the 5 continents. All WEG customers in the marine market have a long-lasting relationship with the company due to the commitment WEG has with their projects and to keep their vessels operating.



Availability = Global service network + Spare parts



Partnership = Local single contact point + Project management



Competitiveness = World class technologies + Class approvals



WEGnology = Know-how + One-stop shop

Whenever you need a reliable supplier of products for **marine applications**, count on **WEG**.





WEG Serves the Marine Industry Globally

Our global structure allows us to be closer to our customers. Over 32 subsidiaries established in key countries are prepared to provide you with technical and commercial support; our manufacturing plants strategically located in the main markets can serve you with short deliveries; and our network of over 1,250 Authorized Service Agents located in the five continents are fully equipped to give you prompt after sales and service support.



Global Presence

Marine Certifications



Company Overview

- Manufacturing plants in 9 countries
- Subsidiaries in 27 countries
- Over 1,250 Authorized Service Agents in the five continents

Global Product Certifications



One-stop Shop for t

With highly efficient and space-saving motors, generators, frequency drives, transformers, switchgears and special marine coating systems, WEG provides a complete range of innovative solutions fit for the toughest marine environments on earth.

WEG quality, cost-effective and environmental friendly products are available individually and are fully customizable, making it the perfect solution for system integrators, shipyards, engineering companies, OEMs and ship owners across the globe.

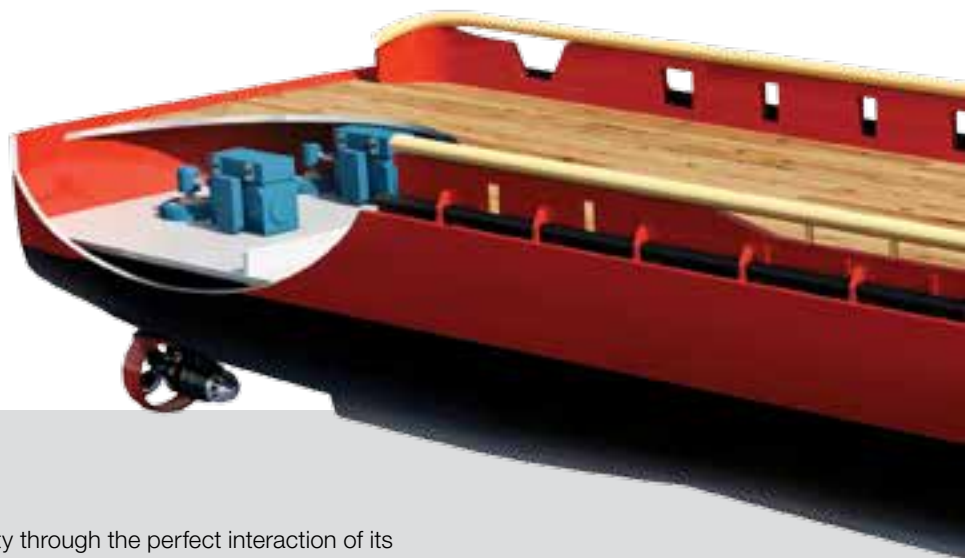
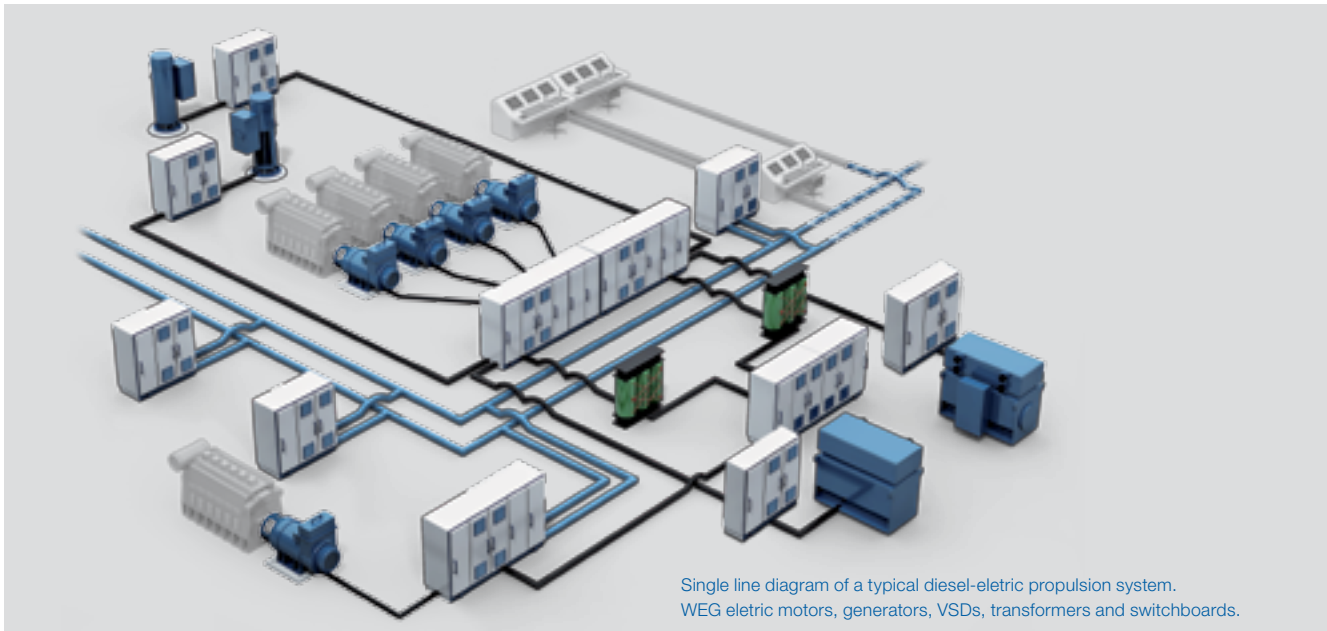

WEG marine solutions provide maximum availability through the perfect interaction of its individual components. Our portfolio also includes special applications, for example, explosion-proof motors, break motors, drives for suction and discharge pumps on dredgers, drives and motors for bow and azimuth thrusters, electrical motors and drive units for onboard pumps, fans, compressors as well as various winches and mooring systems.

the Marine Industry



Motors



Efficiency and reliability on board

Reliability is what matters when electric motors are required for extreme operating conditions: humid, salt-laden and corrosive atmospheres. WEG offers a complete line of electric motors, suitably design for several marine applications, providing premium efficiency and high power density in a compact solution that saves space on board.



WEG motors are fitted with special bearings, reinforced insulation windings, special marine coatings and stainless steel hardware, guaranteeing maximum performance and protection against damaging external effects, such as continuous vibration, heavy pitching and rolling motion under rough sea conditions and aggressive salt-laden ambient.

WGM Motors: Water Jacket Cooled

Designed for Tough Application Conditions

WEG Water Jacket Cooled Motors (WGM Line) can be used especially for driving machines that require constant torque even at low speeds, for long periods of operation (for instance during Dynamic Positioning). It is the right choice for demanding applications in tough Marine environments, with higher ambient temperature and limited space availability.



Advantages

- Low Noise Level
- Suitable for variable frequency drive operation
- Minimum thermal dissipation to the environment
- Compact construction
- Suitable for aggressive operating conditions

The motor cooling is guaranteed by a “water jacket” circulating system between the stator core and the outer frame, allowing a more effective heat exchange which results in a higher output power per weight ratio, therefore reducing the size of the motor. This system is ideal for variable speed applications since the thermal efficiency is optimized even on reduced speeds and where space is a concern.

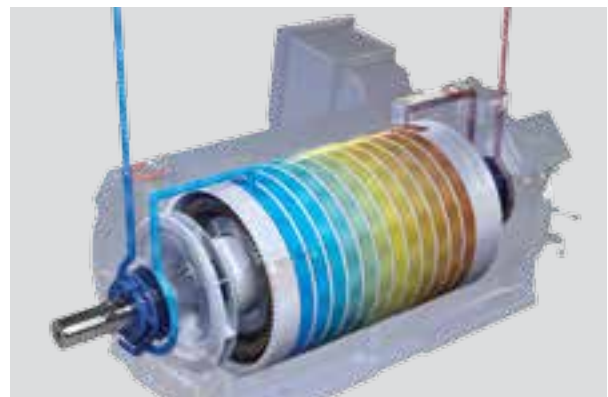

Master Line

- General Purpose Motors**
- Non-Sparking Motors**
- Increased Safety Motors**
- Pressurized Motors**

The Master line (M line) motors stand out for the flexibility of their electrical and mechanical design, adapting to the strictest operating requirements in different applications. The result of this innovative development is a product with high efficiency, meeting the requirements of international standards and in line with the world market trends.

- Output: up to 50,000 kW
 - Voltage: up to 14,400 V
 - Cooling: open, air or water cooled
- * NEMA or IEC designs



Water Cooled Motors



WEG Water Cooled motors were developed to match the increasing market demands for compact design motors with low noise level and high output power ratio per frame size. These motors meet the IE2 efficiency levels defined by IEC 60034-30:2008 Standard, thus ensuring lower energy consumption and consequently reducing their operating costs.

Standard

- Output: 18.5 to 450 kW
- Number of poles: 2 to 8 poles
- Voltage: up to 660 V
- Frequency: 50 or 60 Hz
- Service factor: 1.00 or 1.15
- Degree of protection: IP55
- Insulation class: F or H

HGF: Three Phase Induction Motor

The HGF line is differentiated by its high performance combined with low maintenance costs. This product line is ideal for operating in the toughest applications, which require increased strength and durability of motors.



Standard

- Rated output: 90 kW to 3,150 kW
- Number of poles: 2, 4, 6, 8, 10 and 12
- Frame sizes: IEC 315 to 630
- Frequency: 50 or 60 Hz
- Voltage: 380 V to 6,600 V
- Service factor: 1.00
- Insulation class: F (DT 80 K)
- Degree of protection: IP55

Electrical Motors for Special Applications

WEG develops its portfolio of products always thinking about the special features of each special application:

- Explosion-proof motors
- Break motors
- Motors for suction and discharge pumps on dredgers
- Motors for bow and azimuth thrusters, electrical motors for onboard pumps, fans, compressors as well as various winches and mooring systems



Automation Technologies



CFW11W - WEG variable speed drive (modular water series)

The CFW11W (Modular Water Cooled Low Voltage Variable Speed Drive) **is the perfect WEG solution for System Integrators.** Ideally suitable for Marine & Offshore applications, the CFW11W allows customization on the protection and speed control of AC low voltage motors.

Designed with PWM (Pulse Width Modulation) technology, vector control, output power modules type IGBT and RISC 32 bits processor, the CFW11W modular configuration gives the user great benefits.

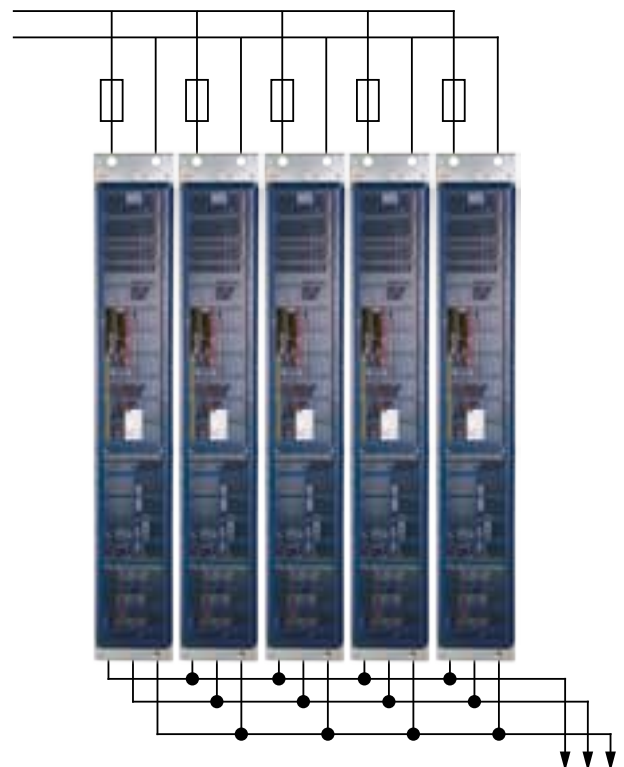
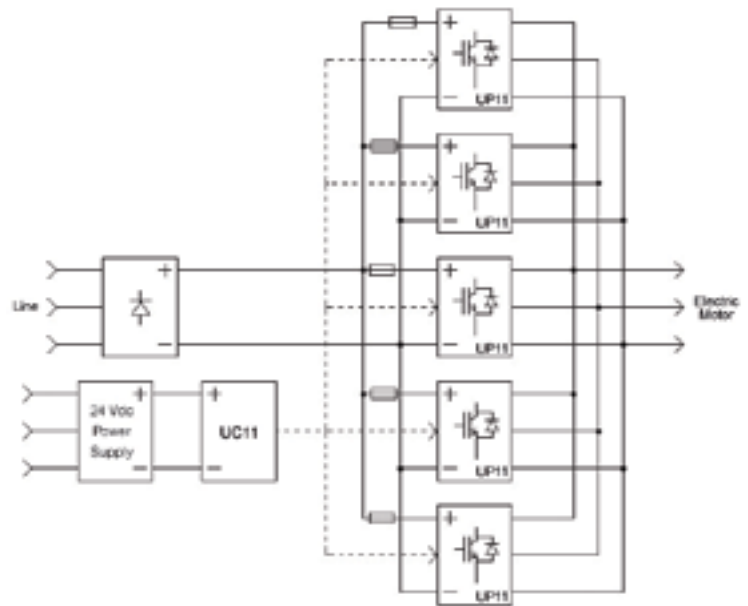

Benefits

- The vector true or sensorless control allows high torque and faster reaction even in low speeds or to start the electric motor
- Human-Machine Interface (UC11) with graphic display, backlight and soft-keys
- Protection with alarm and fault indications
- Overload protection of the motor in accordance with IEC 60947-4-2/UL 508 C
- Trace function to help on start-up and problems diagnoses
- USB Connection

Automation Technologies

On Board Technology for Full Control

WEG frequency converters are fitted with reinforced frames, vibration proof power electronics, special marine coatings as well as anti-condensation heating, guaranteeing a perfect, disturbance-free operation.



Variable Speed Drive CFW11

A new generation of stand-alone air cooled low voltage (LV) VSDs with high-tech features built in, the CFW11 is fitted with Plug and Play technology, able to automatically recognizing motor parameters and set accessories and optionals. Available in power ratings from 1,1 to 370 kW, the CFW-11 adapts itself to the customer's needs through a broad range of accessories, which are easily installed. Besides this, the product comes with the SoftPLC function that attributes PLC functions to the inverter, which allows the customer to create its own applications through the WLP.



CFW11



Low and Medium Voltage Soft-Starters

WEG soft-starters (available up to 3,400 kW and 6.9 kV) are used to protect and limit starting current of electric motors that do not require speed variation. The HMI allows easy parameter set up and makes the commissioning and operation easier.

- **Applications:** propulsion motors with variable pitch propellers, compressors, pumps, fans
- **Benefits:** low cost, less impact in the generation plant during motor start



WEG Drives for HVAC Applications

Thinking of matching energy savings with speed variation on variable torque loads, WEG has developed the CFW501 and CFW701 – a whole new series of variable-speed drives intended for driving of asynchronous motors when heating, ventilation, air conditioning and refrigeration (HVAC) applications are to be met. Offering excellent effectiveness and beyond speed control, HVAC functionalities like broken belt detection, fireman override mode, dry pump, independent PID blocks, short cycle protection (compressors) are equipping the product. Being conscious of the demand for drives with new functionalities brought by the rapid HVAC market evolution, WEG makes available through the HVAC Drives a PLC code programming environment open for users to make their own macros. By just connecting the computer to the drive with WEG Ladder Programmer (WLP) installed the user is good to go.

WEG Medium Voltage Frequency Drive MVW01

Designed to control medium voltage (MV) induction motors, the MVW01 features unique innovations, combining hardware robustness with simplicity, reliability and safety of operations in a compact solution with few components and state-of-the-art technology. Particularly suitable for Marine & Offshore applications, the WEG Medium Voltage Frequency Inverter (MVW01) can be used for the speed control of electric motors in diesel-electric propulsion systems and several other on-board applications, such as large fans, pumps, compressors and hoists.



Main Features:

- Motor voltage: 2.3 kV, 3.3 kV, 4.16 kV or up to 6.0 kV - 6.9 kV
- Power ratings up to 6,000 kW
- 12-pulse diode input rectifier (18 or 24 pulses also available)
- High efficiency (> 99%)
- High power factor (> 95%)
- Low noise level (< 75 dBa)
- Low heat dissipation

Optimal switching it reduces the motor harmonic currents to extremely low levels

- Air or water-cooled

Power Generation

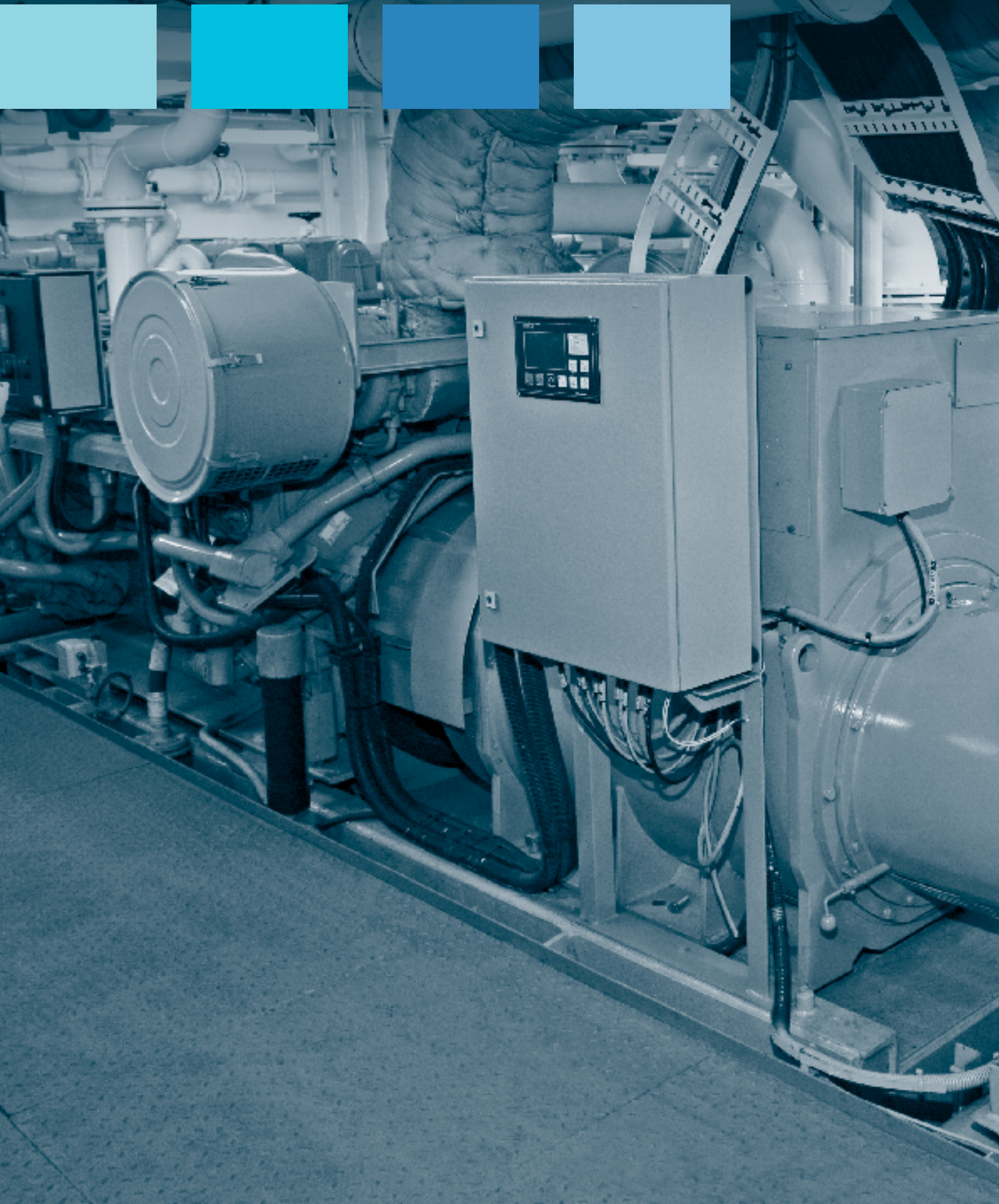

Synchronous Alternators

With extensive experience in the energy sector, WEG offers a wide range of alternators to meet the requirements of different applications in virtually any environment. WEG alternators ensure reliable on-board power supply. In accordance with international classifications societies and in line with individual customers demands WEG delivers fully customized solutions, enabling our clients to stay at the forefront of their industries.

Marine Lines



AN10 Line

- Suitable for gen-sets

Technical Data

- Powers: 1,100 to 3,000 kVA
- Frames: 450 to 560 (IEC)
- Voltage: 440, 690 and 4,160 V
- Frequency: 50 to 60 Hz
- Degree of protection: IP55W
- Insulation class: 180 (H)
- Excitation: brushless
- Number of poles: 4

Features	Benefits
Special coating, components parts and windings	High resistance to corrosion, environments with oil vapor, salt, high humidity and high temperatures
Excellent performance	
Compact	Its reduced dimensions make it suitable for vessels with strict space limitations in the engine room
Flexibility	This line can be adapted to each project
Reliability	The product has special electromechanical features which ensure durability, mechanical strength and robustness



SG10 Line

- Suitable for gen-sets and main propulsion of larger vessels, drilling rigs and FPSO

Technical Data

- Powers: 3,500 to 50,000 kVA
- Voltage: 380 to 13,800 V
- Frequency: 50 to 60 Hz
- Degree of protection: IP23 or IP55
- Insulation class: 180 (H)
- Excitation: brushless
- Number of poles: 4, 6, 8, 10 and 12

Features	Benefits
Robustness	Excellent performance in severe applications
Versatility	Can be supplied with air-air and air-water cooling or open cooling
Low reactance	Meet the main load start requirements

Coatings



Coatings Providing Full Protection

WEG coatings has a wide range of products for several marine and offshore applications, from shop primers for steel plates temporary protection to high build epoxy anticorrosive linings and high performance antifouling systems with up to 5-year docking interval.

Special WEG Marine Paint Plans and Coating Systems

WEG has developed its own line of special marine paint plans and coating systems, providing WEG products with enhanced corrosion protection. Designed for indoor or outdoor installations, WEG electrical motors can also be supplied with a special tropicalized treatment for its internal surfaces and electrical windings, guaranteeing a maximum degree of resistance to corrosion from aggressive atmospheres: salt-laden air, extreme temperatures and permanent moisture.



High Performance Antifouling Coatings Get to Know WEG Ecoloflex SPC

The WEG Ecoloflex SPC was the first hydrolytic self-polishing tin free antifouling developed in the world. Contains a copolymer with special patented technology developed by Nippon Paint Marine Coatings. ***Its performance has been proven in over 10,000 vessels during an operation period of 59-61 months.***

Main Products

- Wegzinc 401 - Weldable zinc silicate shop primer.
- Weg Tar Free 712 N 2851 - Polyamide epoxy primer/top coat.
- Wegpoxi Wet Surface 89 PW - High build surface tolerant epoxy maintenance coating.
- Wegpoxi Wet Surface 88 HT - High thickness IMO-compliant epoxy polyamine primer/top coat for humid surfaces.
- Lackpoxi Wet Surface N 2680 - High thickness solvent-free IMO-compliant epoxy polyamine primer/top coat for humid surfaces.
- Weg Ecoloflex SPC - Tin-free self-polishing antifouling.
- Wegpoxi DRD 331 - High abrasion resistant epoxy primer/top coat.
- Wegthane HPA 501 - Acrylic-aliphatic polyurethane top coat.

General Hull Paint Scheme



Transformers

Dry-Type Transformers

WEG dry-type epoxy insulating transformers are the best option to meet project criteria for safety, space availability, easy installation, and low maintenance costs. The vacuum encapsulation process and the quality of the resin prevent partial discharges and significantly increase the useful life of the transformer. WEG transformers are available with outputs from 300 to 20,000 kVA, in voltage classes up to 36.2 kV, aluminum or copper windings with degree of protection IP00 up to IP55.

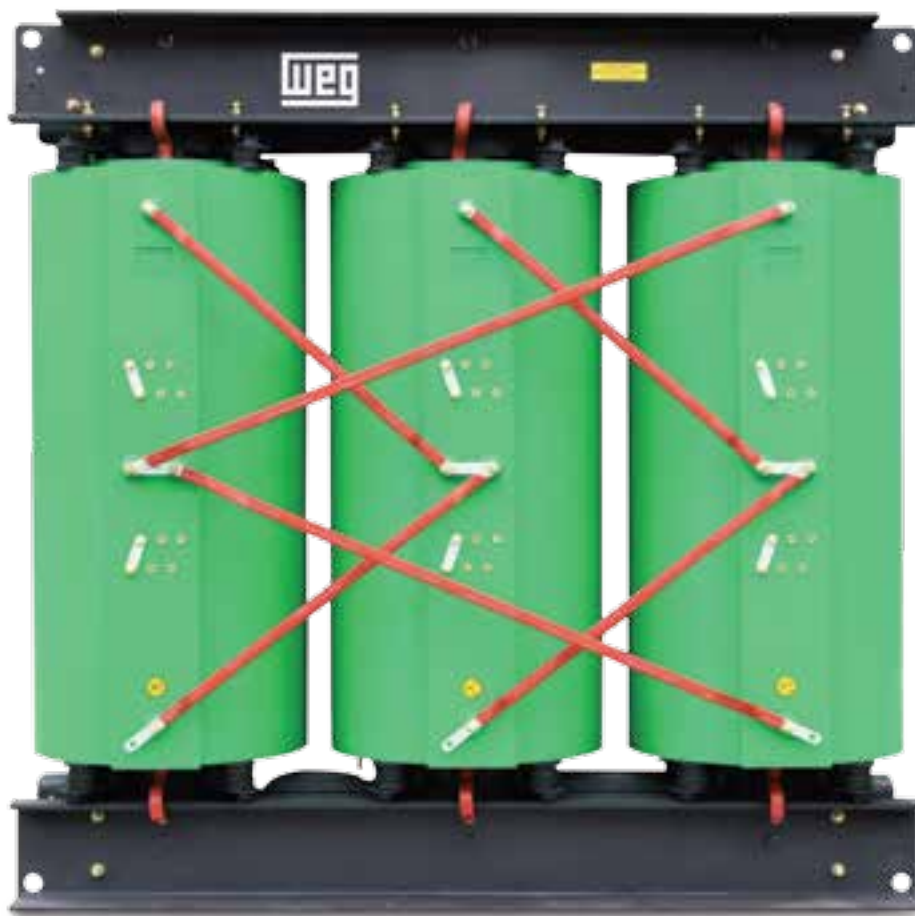

Distribution Transformers (Step-Down)

To distribute the power throughout the different systems on-board the ship.



Double Stock Transformers (Phase Shifting)

Three-phase transformers for VSD use, with multipulse configuration.

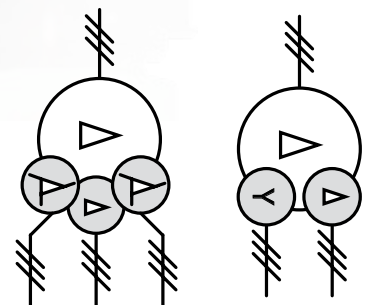

Sustainability

Sustainability has been an integrated part of WEG's philosophy since its foundation. That is why awareness with environment protection has been a major concern in the company for the correct use of natural resources and the application of efficient energetic solutions. As known by nations, the effective use of electric power reduces significantly environmental impacts with further cost savings and improvement of standard of people's life. This is the path followed by WEG's continuous investments on technological innovation as well as development of premium efficiency electric and electronic products which are suitable to operate with high performance, high productivity, low power consumption, reduced operational costs providing outstanding benefits to customers and to the environment. Along its successful history, energy has been the company's focus while manufacturing reliable and highly efficient products for the contribution of a global sustainable development.

Think Green.

We can't
predict
the future, but
we can see
it coming...

WEG Worldwide Operations

ARGENTINA

WEG EQUIPAMIENTOS
ELECTRICOS
San Francisco - Cordoba
Phone: +54 3564 421 484
info-ar@weg.net
www.weg.net/ar

WEG PINTURAS - Pulverlux
Buenos Aires
Phone: +54 11 4299 8000
tintas@weg.net

AUSTRALIA

WEG AUSTRALIA
Victoria
Phone: +61 3 9765 4600
info-au@weg.net
www.weg.net/au

AUSTRIA

WATT DRIVE - WEG Group
Markt Piesting - Vienna
Phone: +43 2633 404 0
watt@wattdrive.com
www.wattdrive.com

BELGIUM

WEG BENELUX
Nivelles - Belgium
Phone: +32 67 88 84 20
info-be@weg.net
www.weg.net/be

BRAZIL

WEG EQUIPAMENTOS ELÉTRICOS
Jaraguá do Sul - Santa Catarina
Phone: +55 47 3276-4002
info-br@weg.net
www.weg.net/br

CHILE

WEG CHILE
Santiago
Phone: +56 2 784 8900
info-cl@weg.net
www.weg.net/cl

CHINA

WEG NANTONG
Nantong - Jiangsu
Phone: +86 0513 8598 9333
info-cn@weg.net
www.weg.net/cn

COLOMBIA

WEG COLOMBIA
Bogotá
Phone: +57 1 416 0166
info-co@weg.net
www.weg.net/co

FRANCE

WEG FRANCE
Saint Quentin Fallavier - Lyon
Phone: +33 4 74 99 11 35
info-fr@weg.net
www.weg.net/fr

GERMANY

WEG GERMANY
Kerpen - North Rhine Westphalia
Phone: +49 2237 9291 0
info-de@weg.net
www.weg.net/de

GHANA

ZEST ELECTRIC GHANA
WEG Group
Accra
Phone: +233 30 27 664 90
info@zestghana.com.gh
www.zestghana.com.gh

INDIA

WEG ELECTRIC INDIA
Bangalore - Karnataka
Phone: +91 80 4128 2007
info-in@weg.net
www.weg.net/in

WEG INDUSTRIES INDIA

Hosur - Tamil Nadu
Phone: +91 4344 301 501
info-in@weg.net
www.weg.net/in

ITALY

WEG ITALIA
Cinisello Balsamo - Milano
Phone: +39 02 6129 3535
info-it@weg.net
www.weg.net/it

JAPAN

WEG ELECTRIC MOTORS
JAPAN
Yokohama City - Kanagawa
Phone: +81 45 550 3030
info-jp@weg.net
www.weg.net/jp

MALAYSIA

WATT EURO-DRIVE - WEG Group
Shah Alam, Selangor
Phone: 603 78591626
info@wattdrive.com.my
www.wattdrive.com

MEXICO

WEG MEXICO
Huehuetoca
Phone: +52 55 5321 4231
info-mx@weg.net
www.weg.net/mx

VOLTRAN - WEG Group

Tizayuca - Hidalgo
Phone: +52 77 5350 9354
www.voltran.com.mx

NETHERLANDS

WEG NETHERLANDS
Oldenzaal - Overijssel
Phone: +31 541 571 080
info-nl@weg.net
www.weg.net/nl

PERU

WEG PERU
Lima
Phone: +51 1 472 3204
info-pe@weg.net
www.weg.net/pe

PORTUGAL

WEG EURO
Maia - Porto
Phone: +351 22 9477705
info-pt@weg.net
www.weg.net/pt

RUSSIA and CIS

WEG ELECTRIC CIS
Saint Petersburg
Phone: +7 812 363 2172
info-ru@weg.net
www.weg.net/ru

SOUTH AFRICA

ZEST ELECTRIC MOTORS
WEG Group
Johannesburg
Phone: +27 11 723 6000
info@zest.co.za
www.zest.co.za

SPAIN

WEG IBERIA
Madrid
Phone: +34 91 655 30 08
info-es@weg.net
www.weg.net/es

SINGAPORE

WEG SINGAPORE
Singapore
Phone: +65 68589081
info-sg@weg.net
www.weg.net/sg

SCANDINAVIA

WEG SCANDINAVIA
Kungsbacka - Sweden
Phone: +46 300 73 400
info-se@weg.net
www.weg.net/se

UK

WEG ELECTRIC MOTORS U.K.
Redditch - Worcestershire
Phone: +44 1527 513 800
info-uk@weg.net
www.weg.net/uk

UNITED ARAB EMIRATES

WEG MIDDLE EAST
Dubai
Phone: +971 4 813 0800
info-ae@weg.net
www.weg.net/ae

USA

WEG ELECTRIC
Duluth - Georgia
Phone: +1 678 249 2000
info-us@weg.net
www.weg.net/us

ELECTRIC MACHINERY

WEG Group
Minneapolis - Minnesota
Phone: +1 612 378 8000
www.electricmachinery.com

VENEZUELA

WEG INDUSTRIAS VENEZUELA
Valencia - Carabobo
Phone: +58 241 821 0582
info-ve@weg.net
www.weg.net/ve

For those countries where there is not a WEG own operation, find our local distributor at www.weg.net.



WEG Group
Jaraguá do Sul - SC - Brazil
Phone: +55 47 3276 4000
info-br@weg.net
www.weg.net

