

MVW01 - MEDIUM VOLTAGE VARIABLE SPEED DRIVE

Efficient, reliable and safe motor control
for a wide range of industrial applications

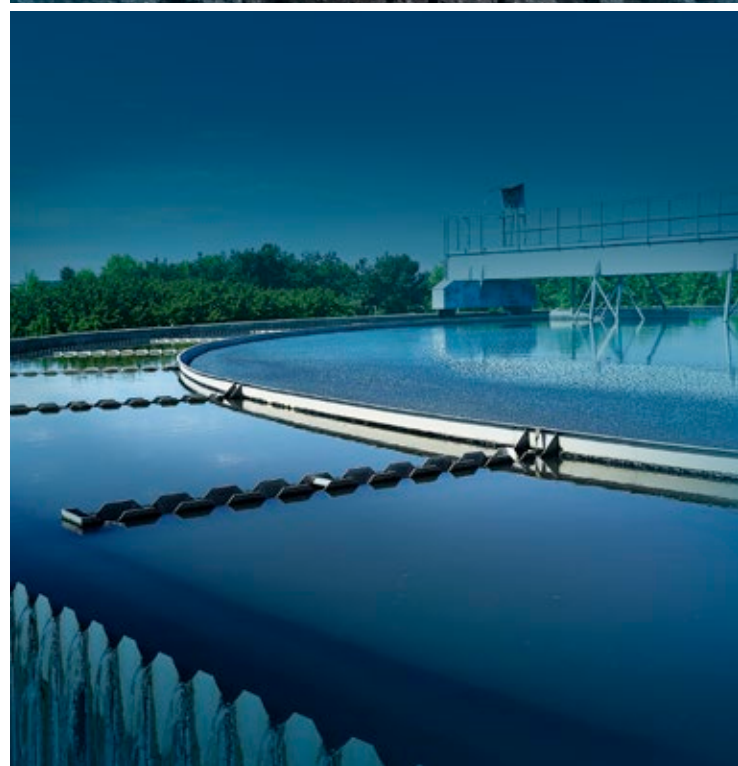

Motors | Automation | Energy | Transmission & Distribution | Coatings



MVW01 - Medium Voltage Variable Speed Drive

Summary

Introduction	04
Applications	06
MV Components	07
Benefits	08
Features	10
System Customized Solutions	16
User-Friendly HMI	17
WEG Programming Suite (WPS)	18
Fielbus Communication	18
MVW01C - Compact Integrated @ IEC	19
MVWCi/MVWMi – Compact Integrated @ UL	20
Water Cooled Version	21
Product Code	23
Dimensions	23
Models	24
Panel Dimensions and Weight	28
Technical Data	30
Testing Facilities	32



EFFICIENT, RELIABLE AND SAFE MOTOR CONTROL FOR A WIDE RANGE OF INDUSTRIAL APPLICATIONS

WEG introduces the third generation of Medium Voltage Variable Speed Drives **MVW01 G3** which offers higher power output capacity compared to the previous generation. This series of WEG Frequency Converters uses MV IGBTs that offers greater efficiency, greater robustness and better protection for the MV motor.

Friendly operator interface “touch screen” provides the operator an easy interaction to program the drive, access and read the parameters, configure the exhibition mode (letters size, languages, colors, etc.), create graphics and also, by means of pop-up windows, see text messages as alarms, trips, error log, help, etc.

MVW01 G3 is applicable for a wide range of industrial applications that need variable speed such as compressors, pumps, fans, conveyor belts, mills, etc. For new or existing installations, the **MVW01 G3** is an efficient and reliable solution that in addition to allowing process speed control, also offers energy saving and reduced operational costs.



HIGH EFFICIENCY



HIGH RELIABILITY



HIGH SAFETY

Main Characteristics

























- Voltage Source Inverter (VSI) featuring NPC topology
- Latest generation power components including MV IGBTs
- Optimum number of power and control components resulting into the highest efficiency design on the market
- High power factor over entire speed range
- Power¹⁾: 500 to 32,000 HP (400 to 24,000 kW)
- Voltage: 2.3 kV to 6.9 kV
- Output frequency: up to 120 Hz

Note: 1) Higher power under request.

Certifications



Applications

  <p>Petrochemicals</p>	<p>Downhole pumps, pipeline pumps, gas compressors, water injection pumps, blowers</p>	  <p>Pulp & Paper</p>	<p>Fans and pumps, grinders, chippers, yankee blowers, winders, refiners</p>
  <p>Mining</p>	<p>Slurry pumps, conveyors, crushers and mills</p>	  <p>Cement</p>	<p>Kiln and baghouse fans, cooler exhaust, forced draft and induced draft fans, crushers and mills</p>
  <p>Water/Waste</p>	<p>Fresh water pumps, sewage and effluent pumps</p>	  <p>Chemicals</p>	<p>Pumps, compressors, extruders</p>
  <p>Plastic & Rubber</p>	<p>Banbury mixers</p>	  <p>Infrastructure</p>	<p>Pumps, compressors</p>
  <p>Power Generation</p>	<p>Forced draft and induced draft fans, boiler feed pumps, recirculating pumps</p>	  <p>Metals</p>	<p>Descaling pumps, cooling pumps and fans</p>
  <p>Marine</p>	<p>Propulsion, thrusters, off-load pumps</p>	  <p>Sugar & Ethanol</p>	<p>Sugarcane mills, fans, blowers, centrifuges</p>

MV Components



Topology with reduced quantity of power semiconductors that increases the efficiency and reliability.

- Voltage Source Inverter (VSI) technology with Neutral Point Clamp (NPC) multilevel power topology featuring optimum number of power components with HV IGBTs
- Phase shifting transformer: 12, 18, 24, 36, 72-pulse
- Option to active front end (4 Q)
- Optimum Pulse Pattern (OPP™) PWM control to minimize current harmonics in the motor circuit
- Long life plastic film capacitors for DC link voltage source (manufactured by WEG)
- DC link voltage balance using transistor (IGBT) switching states
- Floating DC link circuit to minimize voltage stress on motor insulation
- Arc sensor for each power module
- Fuseless design for improved reliability
- Draw-out style power modules with clamp power connections that eliminates connecting or disconnecting of power cables for easy and fast servicing

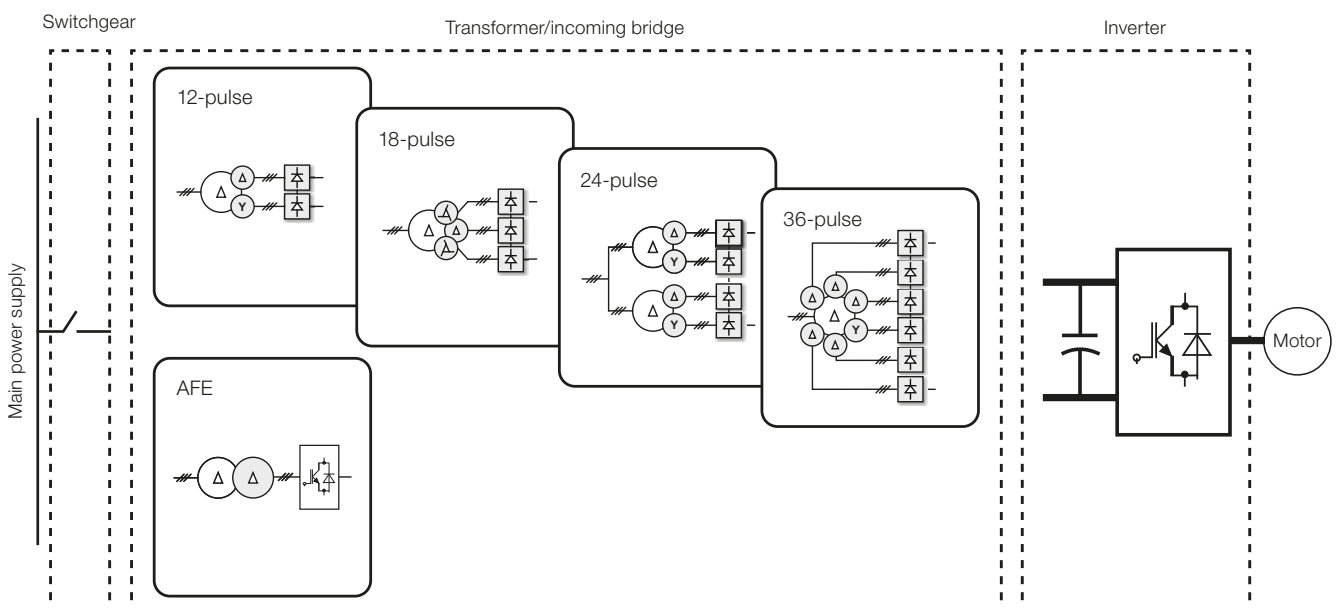

Benefits

Nine Good Reasons Why You Should Consider WEG For Your Complete MV VSD System Solution

1

WEG team delivers an aptly engineered and manufactured VSD system that provides the best solution, while its customers are free to pursue bigger business opportunities.

2

VSDs are built with standard safety features such as mechanical interlocking system, line of sight protection for louvered filter covers and arc flash detection via light sensors.

3

Motor friendly output waveform limits dv/dt , peak voltage levels, current harmonics and with choice of output filters allows use of existing motors with older insulation system, maintaining motor longevity.

4

Phase shifting transformer can be installed outside electrical room to save significantly on HVAC equipment and maintenance.

5

License free PC based software is available for download for paperless recording of parameters and events.

6

Complete system testing including MV Switchgear, Phase Shifting Transformer, MV VSD and MV Motor under full load conditions using dynamometer at largest motors & drives facility in South America.

7

Factory specialists can provide customers total assistance with quick response time when necessary and actively provide support via authorized service centers.

8

Quality Control: ISO 9001 and ISO 14000 certified factory with strict QA procedures mandate functional tests for all control boards and two hour load testing for each VSD shipped.

9

WEG R&D team dedicated exclusively for the MV VSD, helps in developing state of the art hardware and software functions.

Benefits

Input Switchgear

- System input protection
- Mechanically and electrically interlocked with VSD
- Metal clad switchgear with CB or metal enclosed with disconnect switch + vacuum contactor + MV fuses
- Opens under VSD command in less than 100ms
- Existing switchgear can also be used with basic open/close/trip signals and feedback

Phase Shifting Transformer

- Provides complete system isolation for common-mode voltage stress mitigation on the motor
- Natural harmonic reduction on the power supply
- Fault current limitation
- Voltage matching
- Flexibility of installation with dry type or oil type
- Installation can be indoor or outdoor
- Isolates the system from supply side grounding and in case of ground fault, VSD generates alarm while keeping motor operation under control or can be programmed for safe trip

MVW01 MV VSD

- Latest generation of MV power transistors (IGBTs)
- Modular rectifier section: 12P, 18P, 24P, 36P or 72P rectifier
- Long life plastic film capacitors for DC link voltage
- Optimum Pulse Pattern (OPP™) PWM control to minimize voltage harmonics in the motor circuit
- Draw-out style power modules
- Optimized for inverter duty motors
- Customized with optional filters for standard motors

WEG MV Motor

- Synchronous or induction motor control
- Standard motor voltages: 2.3 kV, 3.3 kV, 4.16 kV, 5.5 kV, 6.0 kV, 6.6 kV
- System optimization with inverter duty motors
- Possibility of working with non inverter duty motors or old motors (retrofitting)



Features



Input: 12, 18, 24, 36, 72-Pulse Rectifier Bridge or AFE (Active Front End) Option

- High power factor (>0.95)
- High power quality
- IEEE 519 compliance

Cable Connections

- Bottom cables (power and control) entry or top cables (power or control) entry

Power Arms

- Latest generation of power semiconductors and capacitors
- Simple control connection with fiber optics
- Draw-out style power modules with stab power connections that eliminates connecting or disconnecting of power cables allowing easy and fast servicing



Air-Cooling

- Redundant fans
- Low heat dissipation
- Low noise level
- No maintenance hassle of water cooled systems

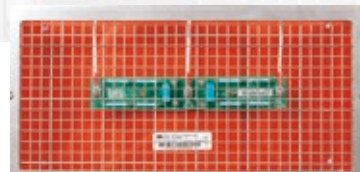
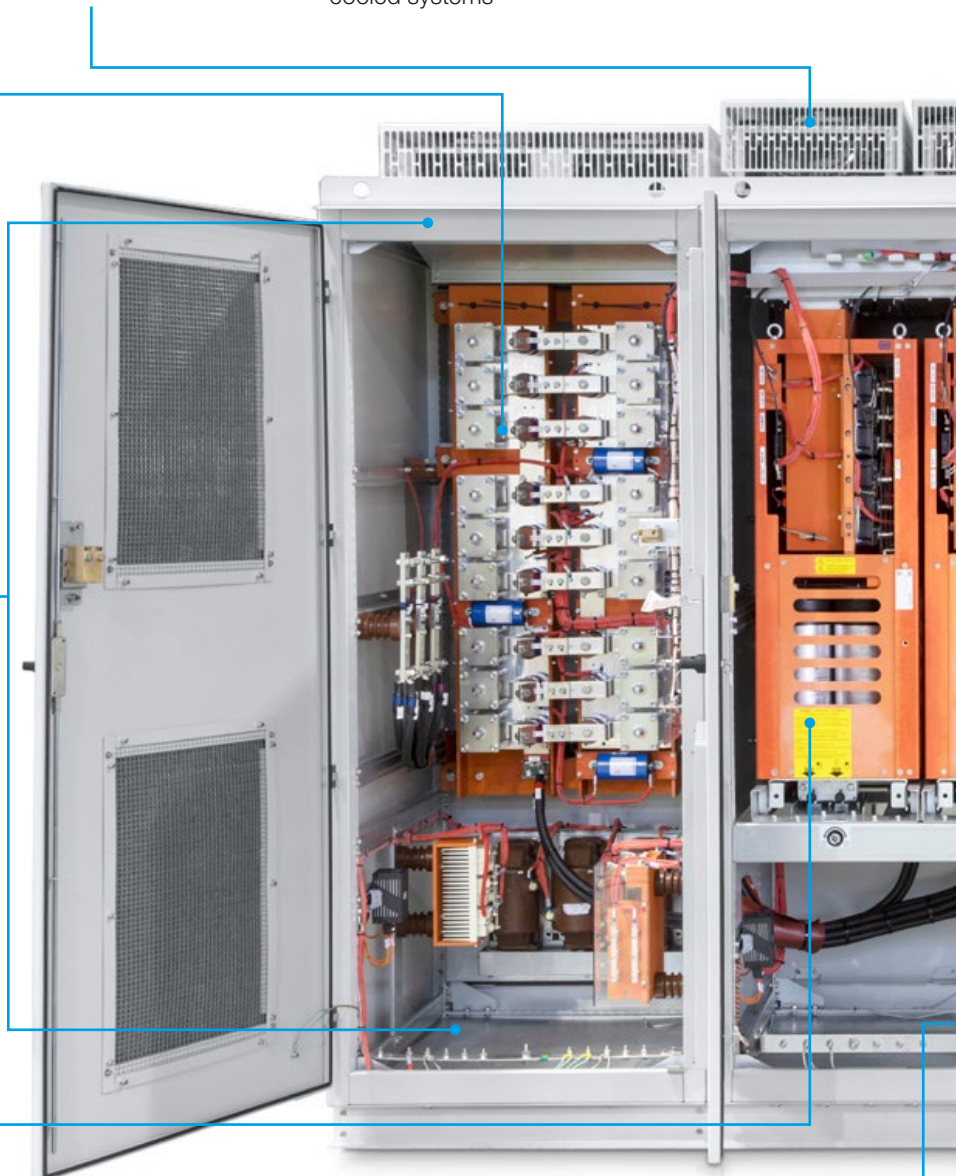

DC Link Voltage Monitoring

- Visual indication of presence of voltage on the DC link for additional personnel safety

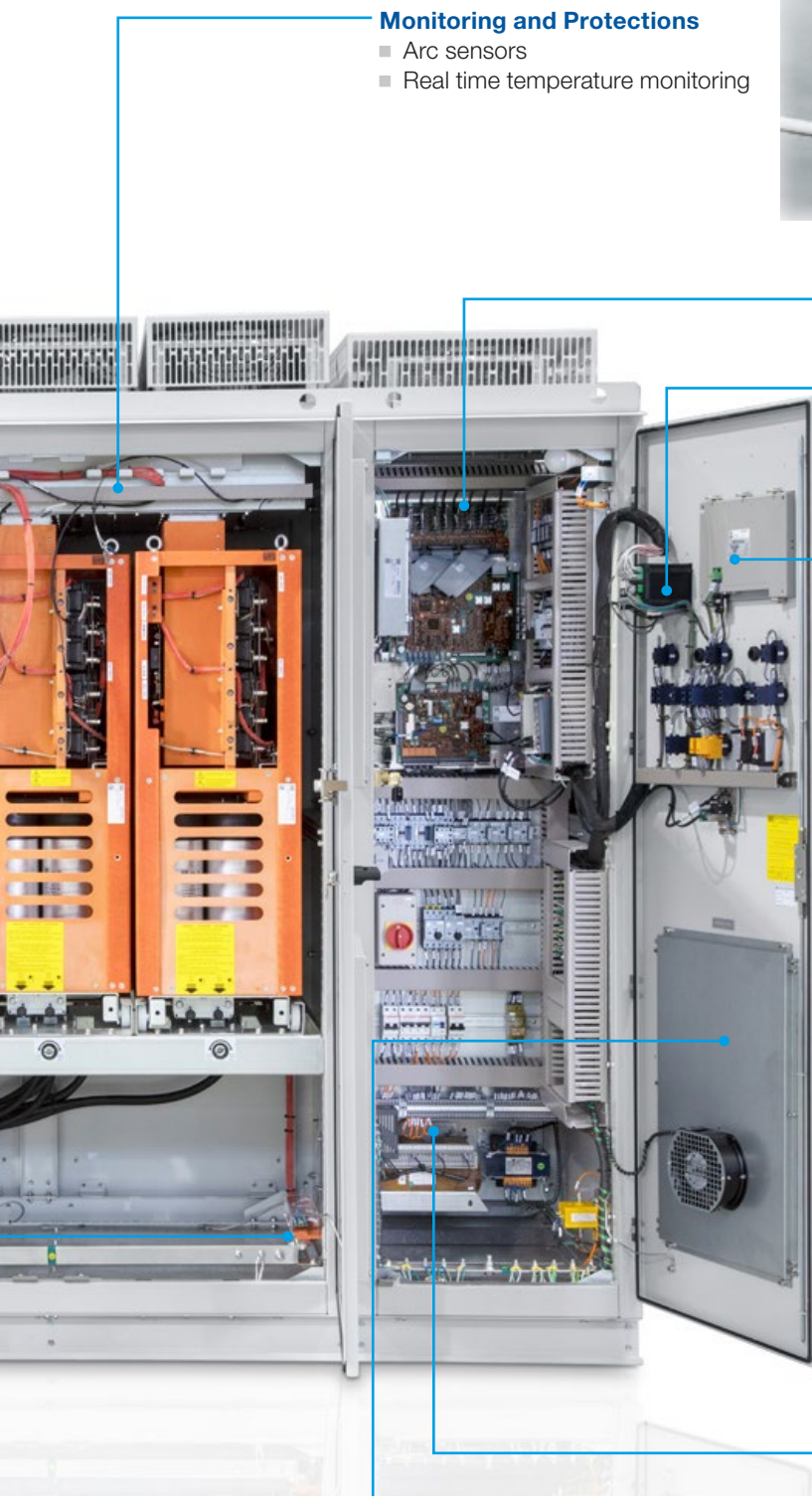

Monitoring and Protections

- Arc sensors
- Real time temperature monitoring



Thermal Protection

- Pt-100 individual monitoring for motor thermal protection (bearings and windings)



Fiber Optic Interface

- Noise immunity
- Isolation between the control and power section
- Gate drivers, temperature monitoring, feedbacks, etc.

IHM Touch Screen 10"

- Graphic display
- Full operation, navigation, programming and monitoring
- Complete parameters instructions and fault descriptions
- Numerical and/or bars display



Air Inlet Filters

- Washable and replaceable from the front without disturbing the normal operation



Mechanical Lock Safety

- Safety operation with mechanical lock for the power sections
- Electro-mechanical interlocking with the main input breaker to prevent access to MV section when the main breaker is closed

Features

Topology

The MVW01 G3 is a VSI (Voltage Source Inverter) medium voltage frequency converter NPC topology in 3/5 level (2.3 kV to 4.16 kV) or 5/9 levels (5.5 to 6.9 kV) that offers high reliability and robustness. Designed with state-of-the-art technology to control induction or synchronous motors, it has a minimum number of power semiconductors, which allows us to have a highly efficient and reliable product.

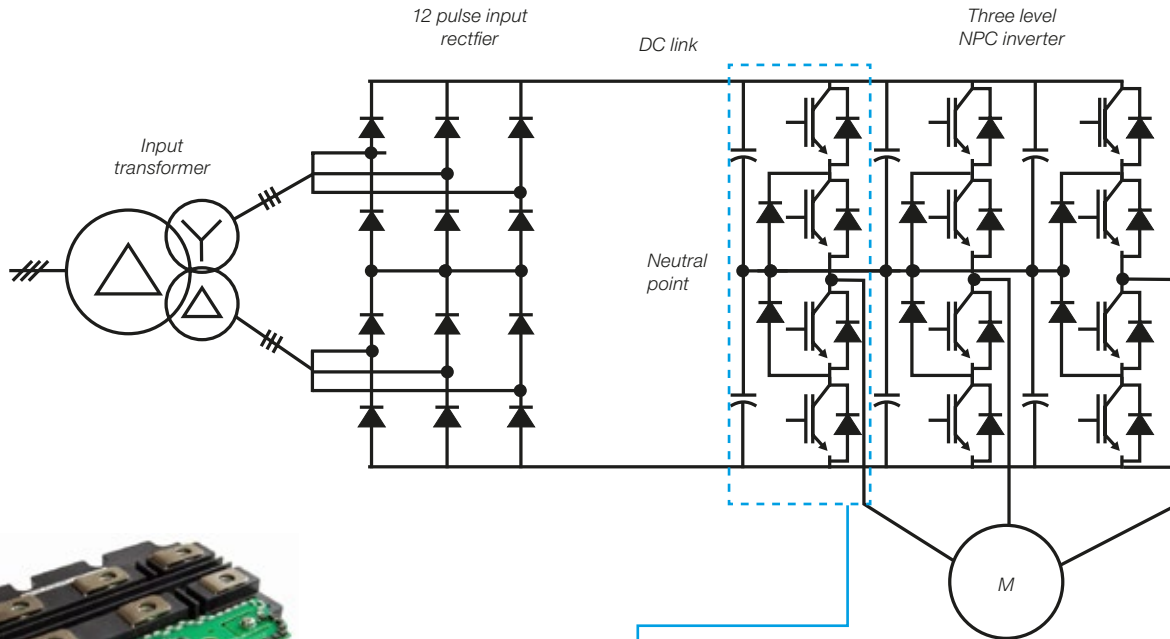

Latest generation of HV IGBTs

INVERTER POWER ARM

Optimized sandwich bus-bars to provide a high insulation and small partial discharge levels



Long life plastic film capacitors for DC link voltage source manufactured by WEG (same capacitors used by the aero-space industry in satellites)

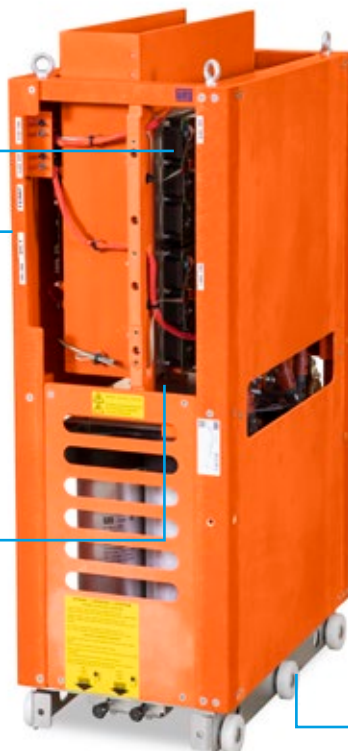

Draw-out style power modules allowing easy and fast servicing

Features

Latest Technology

The power semiconductor devices are the most important components of the Medium Voltage Variable Speed Drive and in conjunction with the electronic control circuits, it is possible to determine the efficiency and reliability of the product. Taking these characteristics into account, WEG use the latest generation of HV IGBTs available on the market in MVW01 G3, which allows the application of a low quantity of semiconductors at the power stage and allows the use of a robust and low-power electronic control circuit.

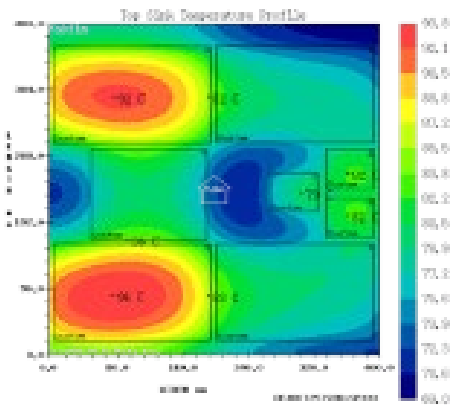

Advanced thermal studies of WEG R&D team together with one of the most important semiconductor manufacturers in the market, allowed WEG to develop the first MV VSD with the latest generation of MV IGBTs for general industrial purpose in the world.

Why Should I Choose HV IGBTs Instead of Other Power Devices?

- Natural strength against short-circuits and over-currents (other devices need extra power components)
- Simplified gate driver circuit (others are much more complex and need electrolytic capacitors for high energy commutation demand)
- Simpler for parallel configuration when compared to other power component devices
- Module with isolated base (easy and fast servicing)
- Positive temperature coefficient for saturation voltages (do not need special snubber circuits)
- IGBTs became standard for LV drives now it is the trend in MV drives with multiple manufacturers



Features



Ride Through

The MVW01 VSD is designed and manufactured to take intelligent remedial action to prevent transient supply faults or overload conditions from tripping the VSD.



Flying Start

The MVW01 VSD is capable of restarting and taking control of a motor attached to a spinning load in the forward or reverse direction.



Auto-Restart Capability

The MVW01 VSD is capable of automatically restarting in the event of a momentary loss of power, or a clearing of a drive trip.



Ground Fault Protection

In the event of a ground fault, the MVW01 is capable of annunciating the ground fault condition, safely operating and, by user selection, either trip or continue operation.

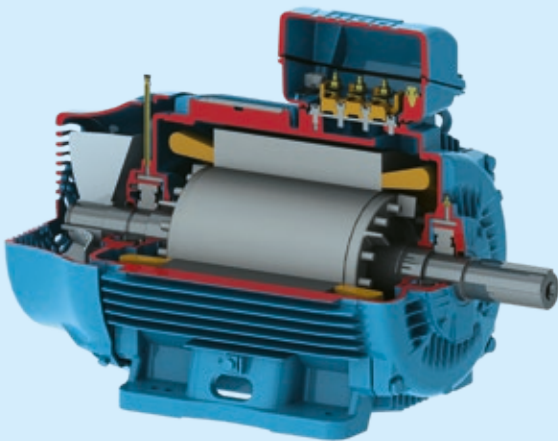

Optimal Pulse Pattern (OPP™)

Optimum synchronous PWM control minimizes voltage harmonics in the motor circuit and provides the capability to adjust PWM frequency to an optimal use at every speed for every type of application.

Main Benefits of WEG OPP

- Low commutation losses
- Low motor current THD
- Operation at very low frequency with full torque
- Low noise and vibration on the motor



Output Harmonics with OPP Modulation
MVW 01

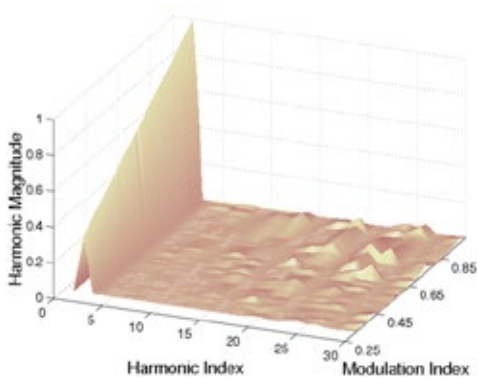

Output Harmonics with Standard SVM Modulation

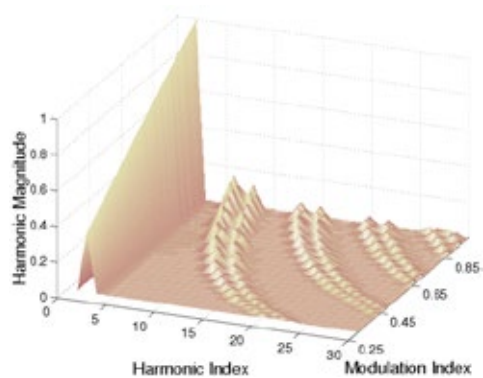

Features



Main Protections

- Overload protection (I x t)
- Over/under voltage protection
- Phase loss protection
- Pre-charge circuit fault
- Ground fault
- Optical fiber feedback circuits fault
- CPU Watchdog/EPROM
- External fault
- Speed feedback encoder loss
- Network communication failure
- "Power on" errors
- Output over current
- Input/output short-circuit
- Power supply phase fault
- DC Link checking (power on, short circuit, over/under voltage)
- IGBT fault (optical fiber problem, gate fault, firing fault, etc.) with individual identification

General Features

- Fault registers: 100 last fault and alarm records with date and time
- Slip compensation
- Adjustable speed and current limits
- Adjustable overload curve
- Copy function of the programming keypad (HMI)
- Flying Start & Ride Through
- Multi-Speed function (up to 8 speeds)
- Skip (critical) speed function
- Motor rated frequency adjustments
- 03 differential analog inputs (10 or 12 bits resolution analog input)
- 04 analog inputs (2x 0...10 V and 2x 4...20 mA)
- 08 fully programmable digital inputs
- 08 fully programmable digital outputs



System Customized Solutions



WEG customized solutions are based on standard VSD designs and experience gained through the supplying of a demanding variety of applications.



- MVW01 AFE/REGENERATIVE/4Q Version
- MVW01 WC - Water Cooled Version
- MVW01 with 2,300 V output voltage
- MVW01 with output earth switch (ground switch)
- MVW01 with output filters (reactors, dv/dt and sine)
- MVW01 with internal UPS for control power backup
- MVW01 with special painting
- MVW01 with enclosure IP21/IP41/IP42
- MVW01 with air duct for external venting of exhaust airflow
- MVW01 with redundant ventilation
- VW01 with field excitation for MV Synchronous Motors
- MVW01 with external bypass system to be connected the MV MOTOR direct to power grid
- MVW01 with special application software: Frozen Charge Function, Load Sharing Function, Synchronous Multimotor Transfer Function to power grid line, Gearless Mill Function, etc.



Gearless Mill Drive Function



Load Sharing Function



Frozen Charge Function

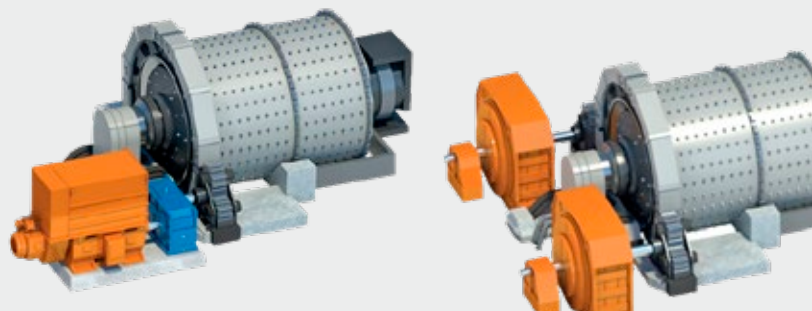

User-Friendly HMI

HMI Touch Screen

The “HMI touch screen” allows full access to the real-time operating data of the MVW01 G3, which allows the user to interact / monitor the variables, program, verify the operational status and create graphs of the variables in local mode (when installed on the front door of the electrical panel) or in remote mode (example: installed on a control table).

The extremely user friendly HMI provides the operator an easy interaction to program the drive, access and read the parameters, configure the exhibition mode (letters size, idioms, colors, etc.), create graphics and also, by means of pop-up windows, see text messages as alarms, trips, error log, help, etc.



Structure of Menu Parameters



Graphic Monitoring of Variables



Text Size Setting



Numeric Display and Bar

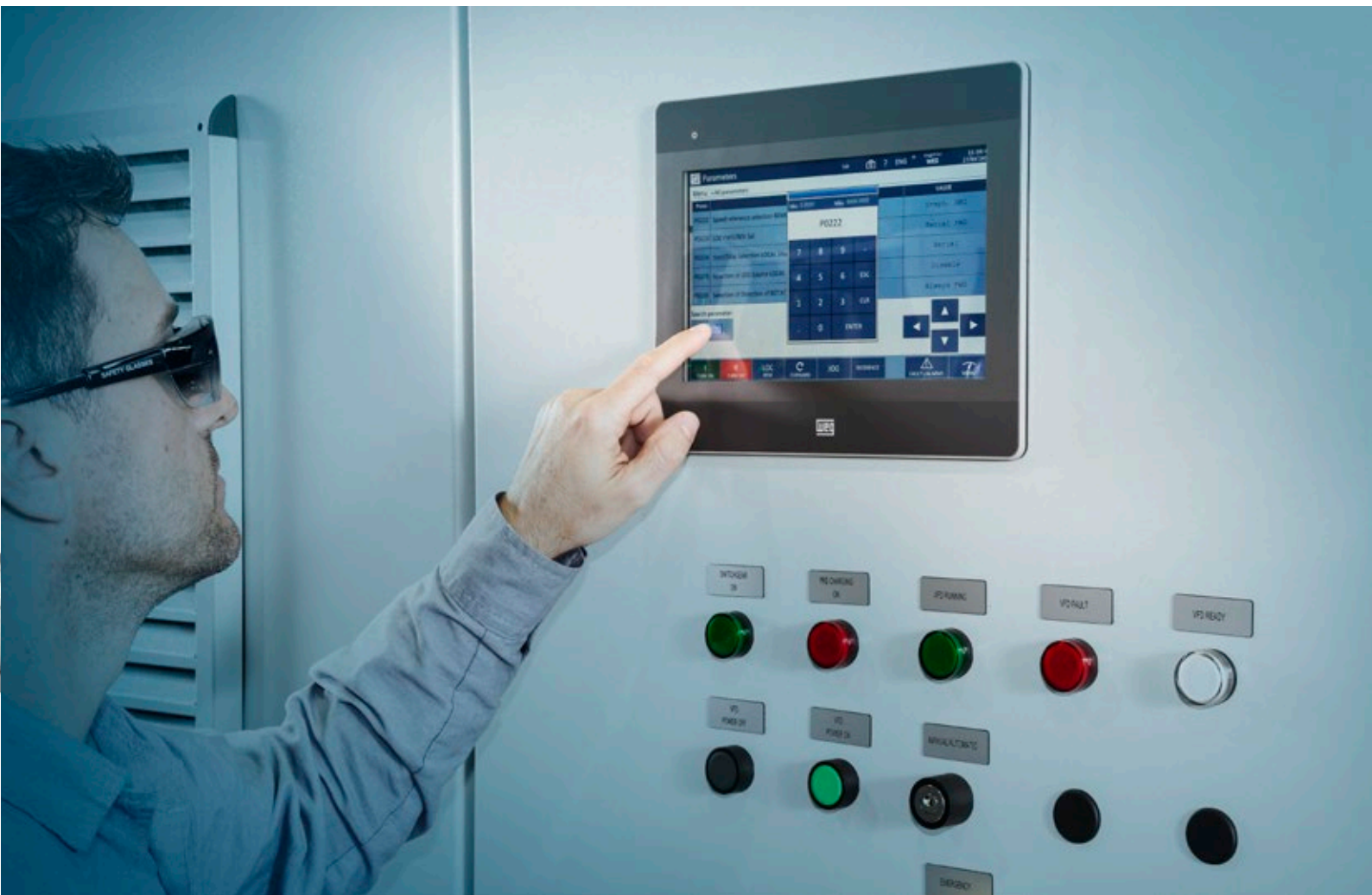

WEG Programming Suite (WPS)



Superdrive G2

License free software (available at WEG website) for total control and monitoring of WEG MVW01.

- Parameter upload and download
- VSD operation
- VSD monitoring
- On-line and off-line programming



Trace function

Fieldbus Communication

The MVW01 supports various communications protocols including Modbus-TCP (standard built-in), Modbus-TCP, DeviceNet, Profibus-DP or Profibus-DPV1, EtherNet/IP, CANopen and others, allowing total process monitoring, controlling and complete integration of the system.



MVW01C - Compact Integrated @ IEC

MVW01 integral drive system includes all components that are required for a MV VSD standard system design on a small foot print.

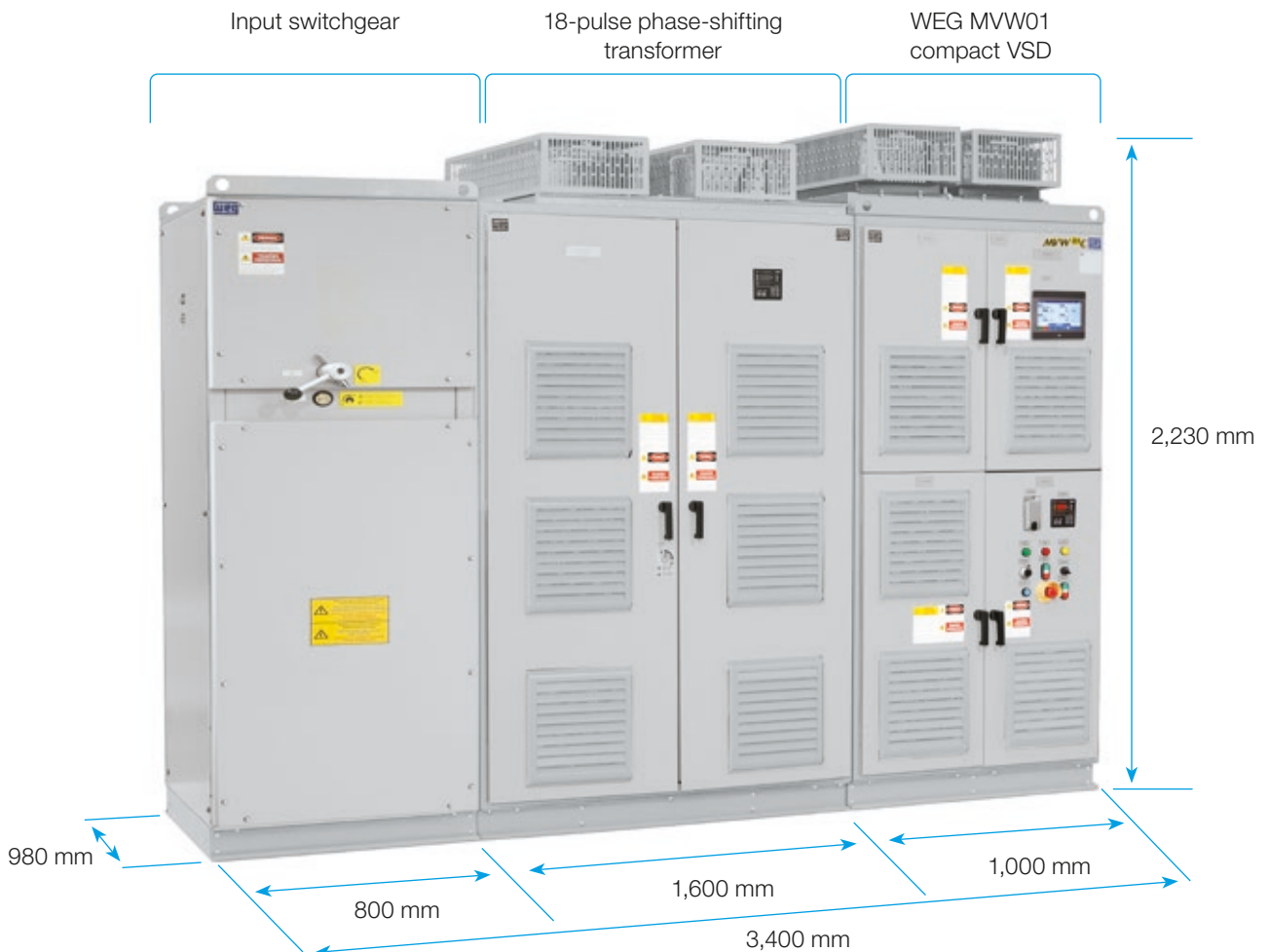

Standard Arrangement and Features

Input Switchgear

- Switch + fuse + vacuum contactor - for up to 6.9 kV, 3 Ph, 60Hz
- Mechanical interlocking to prevent access to HV section until switch is in OFF position
- Bottom cable entry or top cable entry

Phase Shifting Transformer 18-Pulse as Standard

- With surge arresters on primary HV side
- Impedance matched secondary windings to minimize line side harmonics & reduce losses
- Winding temperature monitoring (Pt-100 in windings) available via 8 channel temperature monitor

Assembly Features

- Cable connection arrangement top entry/top exit or bottom entry/bottom exit
- Mechanical Interlocking System for switchgear, dry phase shifting transformer and MV VFD

MVWCi/MVWMi – Compact Integrated @ UL

Integrated solution with 24P rectifier generates very low harmonics at Point of Common Coupling (PCC).



Variations/Features

- 400 HP - 4,000 HP, 4.16 kV, 60 Hz
- Standard NEMA1 (IP21 to IP43) panel assembly for indoor installation
- Mechanical Interlocking fused disconnect switch with vacuum contactor
- Double tier base frame for passing of power cables/control cables between sections
- VFD transformer can be installed in drive lineup or away from the lineup
- Transformer is available in VPI design for indoor installation or outdoor installation
- Transformer is also available in oil type (mineral oil or FR3) for outdoor installation (pad mount)



Motor		Nominal motor current (Amp)	MVWCi / MVWMi	Dimensions H x W x D (inches)	Approx. weight (Lbs)	Heat loss kW
kW	HP					
300	400	49	MVW Ci 0400	99 x 106 x 40	5,000	8.25
373	500	61	MVW Ci 0500	99 x 106 x 40	5,000	9.30
448	600	74	MVW Ci 0600	99 x 114 x 40	5,000	11.20
522	700	86	MVW Ci 0700	99 x 114 x 40	6,500	13.00
597	800	98	MVW Ci 0800	99 x 114 x 40	6,500	14.90
672	900	110	MVW Ci 0900	99 x 114 x 40	6,500	16.80
746	1,000	123	MVW Ci 1000	99 x 122 x 40	8,000	18.65
933	1,250	153	MVW Ci 1250	99 x 122 x 40	8,000	25.33
1,119	1,500	184	MVW Mi 1500	96 x 161 x 40	10,800	30.00
1,306	1,750	215	MVW Mi 1750	96 x 161 x 40	11,500	36.00
1,492	2,000	245	MVW Mi 2000	96 x 161 x 40	11,500	41.00
1,679	2,250	276	MVW Mi 2250	96 x 161 x 40	12,400	46.17
1,865	2,500	307	MVW Mi 2500	96 x 161 x 40	12,400	51.30
2,052	2,750	337	MVW Mi 2750	96 x 176 x 40	14,800	56.43
2,238	3,000	368	MVW Mi 3000	96 x 176 x 40	15,900	61.55
2,611	3,500	430	MVW Mi 3500	96 x 228 x 40	20,200	77.74
2,982	4,000	490	MVW Mi 4000	96 x 228 x 40	23,500	66.65

Notes: 1) Motor current is for 4P motor operating at 4.16 kV, 60 Hz, with 0.87 P.F. and 97% efficiency at full load.
 Overload 115% for 60 seconds (for 1,350 HP, overloads 110%).
 1 kW = 3,412.14 BTU/hr. for heat loss.
 Indoor heat loss can be reduced by 50% or more, with transformer installed outdoors. Consult WEG for this option.
 2) The technical characteristics informed in the table above may changes without notice.

Water Cooled Version

MVW01 water-cooled version is perfect for high power and demanding applications, such as environments with harsh conditions. It is also the ideal solution when hot air cannot be dissipated and air-conditioning is not a viable solution commercially.

Double independent water circuit consisting of internal closed loop, internal water-to-water heat exchanger and external water circuit, provides MVW01 a high efficiency cooling system to dissipate the losses away from the electrical room.

Reliable water circuits using quick release water connectors with retention avoids undesirable water drops inside the panel even in case of maintenances and redundant pumps to guarantee the continuous operation of the cooling system.

No special treatment for the external water is required.



Cooling System Features

- The primary water circuit (inside) can be installed left or right side operating in close loop (without external access)
- Exchanger heat designed to operate with fresh water (inhibited fresh water)
- Primary water circuit can be provided to operate with demineralized water or deionized water
- Primary water circuit with two redundant pumps that can be operated in manual mode or in automatic mode
- The special fluid is transported internally in the electrical panel by tubes of PVC material
- Use of the fast connectors to connect/disconnect the hoses to the power modules (semiconductors)
- Pressure, temperature and flow sensors for monitor the conditions of the coolant, alarm indication or trip indication



Primary Circuit

Secondary Circuit

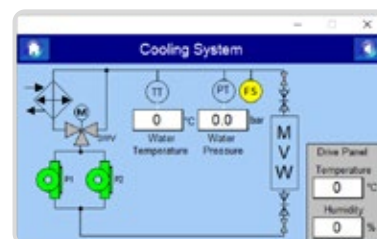

Water Cooled Version

Standard Features to MVW01 Water Cooled Version

- IP54 protection degree
- Redundant pumps for the Water Cooled system
- 10" Touch Screen HMI
- Conformal coating to all electronic cards

Bridge Rectifier Bridge in 12, 18, 24, 36 and 72 Pulses:

- High power factor (> 0.95)
- High power quality
- IEEE-519 compliance

Monitoring and Protections

- Arc sensors protection
- Real time temperature monitoring

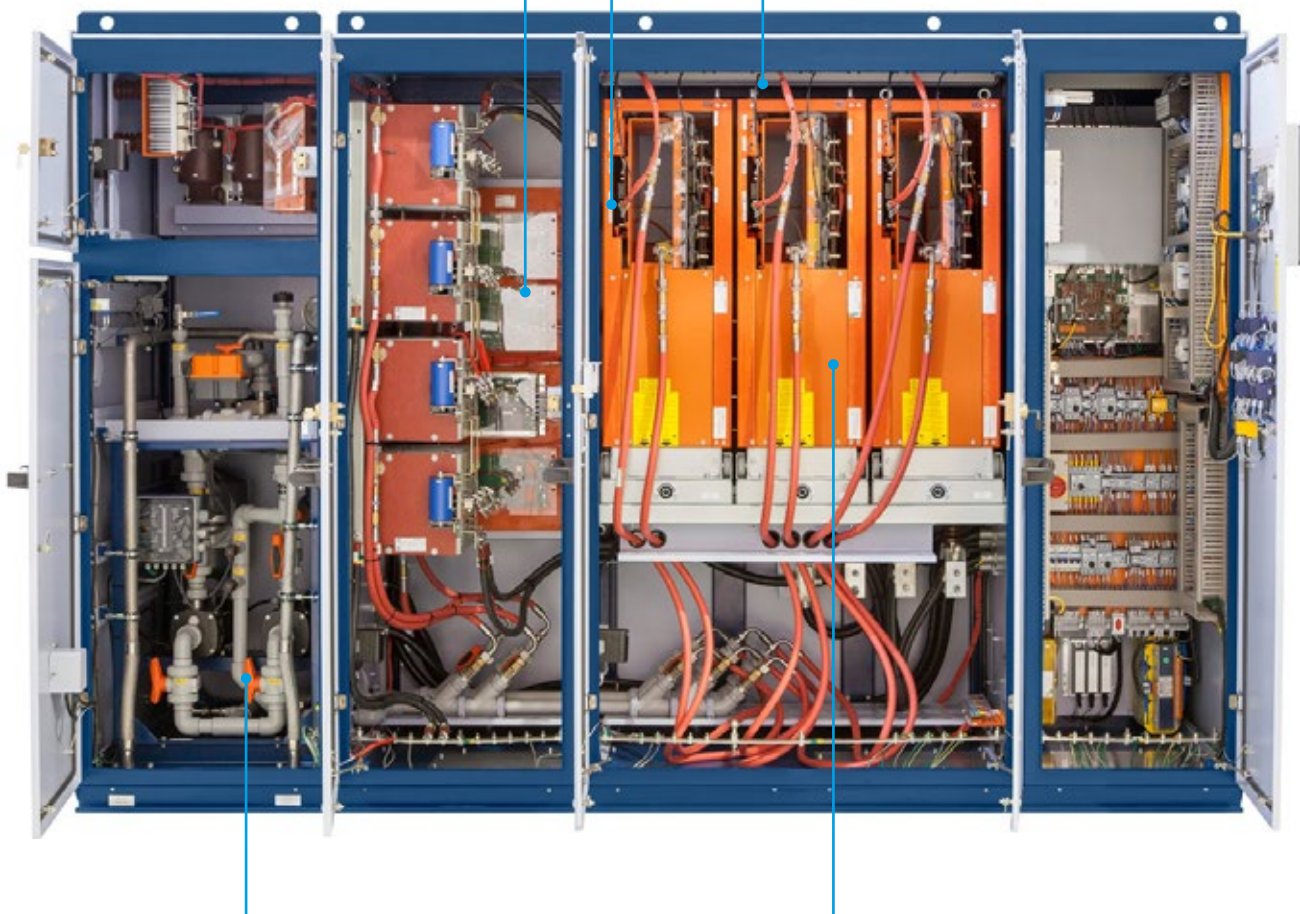

Exchanger Heat (Primary Water Circuit – Inside Electrical Panel)

- Redundancy Pumps
- Close Loop Water circuit
- Tubes of PVC material
- Fast connectors to connect /disconnect

Power Arms

- Latest generation of power semiconductors and capacitors
- Removable arms with mechanical clamps to connect to the output bus (without cables to connect, easy removal and quick maintenance)
- Special sink water-cooled version

Product Code

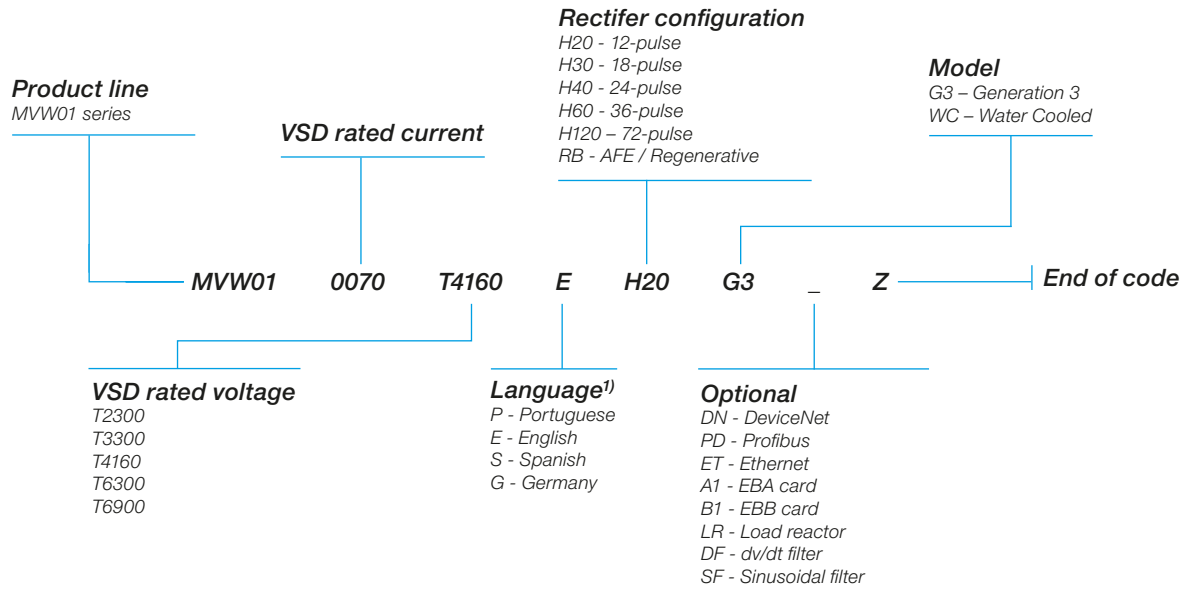

Note: 1) Other languages, please contact WEG.

Dimensions



Models

MVW01 G3 – Air Cooled VSD – 2,300 / 3,300 V & 4,160 V

Output rated current			Product	Motor power				Frame size	Rect. pulses	Phase shifting transformer
ND	HD	Mx		ND		HD				Suggested power rate in ND
A				HP	kW	HP	kW			kVA
3,300 V										
96	85	98	MVW01 C096 T3300 EHxxG3Z	600	450	500	400	A0	1x18 or 1x24	549
113	99	116	MVW01 C113 T3300 EHxxG3Z	700	500	600	450			646
131	115	134	MVW01 C131 T3300 EHxxG3Z	800	630	750	560			749
152	134	155	MVW01 C152 T3300 EHxxG3Z	900	710	800	630			869
176	155	180	MVW01 C176 T3300 EHxxG3Z	1,100	850	900	710			1,006
204	180	214	MVW01 0204 T3300 EHxxG3Z	1,250	1,000	1,100	800	A	1x12 or 1x18 or 1x24	1,166
237	208	249	MVW01 0237 T3300 EHxxG3Z	1,500	1,100	1,350	1,000			1,355
276	242	290	MVW01 0276 T3300 EHxxG3Z	1,750	1,250	1,500	1,120			1,578
322	280	338	MVW01 0322 T3300 EHxxG3Z	2,250	1,600	2,000	1,400			1,840
376	325	395	MVW01 0376 T3300 EHxxG3Z	2,500	1,800	2,250	1,600			2,149
450	390	460	MVW01 0450 T3300 EHxxG3Z	3,100	2,300	2,600	2,000			2,572
560	490	590	MVW01 0560 T3300 EHxxG3Z	3,800	2,800	3,300	2,500			3,201
607	526	639	MVW01 0607 T3300 EHxxG3Z	3,850	3,000	3,600	2,600			3,469
713	618	751	MVW01 0713 T3300 EHxxG3Z	4,500	3,550	4,000	3,000			4,075
855	741	874	MVW01 0855 T3300 EHxxG3Z	5,800	4,300	5,000	3,800			4,887
1,064	931	1,121	MVW01 1064 T3300 EHxxG3Z	7,250	5,300	6,000	4,500	6,082		
1,170	1,013	1,195	MVW01 1170 T3300 EHxxG3Z	8,000	6,000	6,900	5,200	6,687		
1,283	1,111	1,311	MVW01 1283 T3300 EHxxG3Z	8,800	6,600	7,600	5,700	7,333		
1,596	1,396	1,681	MVW01 1596 T3300 EHxxG3Z	11,000	8,200	9,600	7,100	9,122		
1,710	1,482	1,748	MVW01 1710 T3300 EHxxG3Z	11,700	8,700	10,200	7,600	9,774		
2,128	1,862	2,242	MVW01 2128 T3300 EHxxG3Z	14,600	10,900	12,800	9,500	12,163		
2,565	2,222	2,622	MVW01 2565 T3300 EHxxG3Z	17,500	13,000	15,000	11,000	14,661		
3,192	2,792	3,362	MVW01 3192 T3300 EHxxG3Z	22,000	16,000	19,000	14,000	18,245		
3,420	2,964	3,496	MVW01 3420 T3300 EHxxG3Z	23,000	17,500	20,000	15,000	19,548		
4,256	3,724	4,484	MVW01 4256 T3300 EHxxG3Z	29,000	21,000	25,000	19,000	24,326		
4,160 V										
78	70	85	MVW01 C078 T4160 EHxxG3Z	600	450	550	400	A0	1x18 or 1x24	562
92	83	101	MVW01 C092 T4160 EHxxG3Z	700	560	650	500			663
108	98	118	MVW01 C108 T4160 EHxxG3Z	850	630	750	600			778
128	115	140	MVW01 C128 T4160 EHxxG3Z	1,000	710	900	630			922
151	135	165	MVW01 C151 T4160 EHxxG3Z	1,200	900	1,100	800			1,088
181	162	195	MVW01 0181 T4160 EHxxG3Z	1,500	1,100	1,300	1,000	1,304		
216	195	233	MVW01 0216 T4160 EHxxG3Z	1,700	1,250	1,600	1,100	1,556		
260	235	280	MVW01 0260 T4160 EHxxG3Z	2,200	1,600	1,900	1,400	1,873		
294	265	312	MVW01 0294 T4160 EHxxG3Z	2,500	1,800	2,200	1,600	2,118		
330	290	350	MVW01 0330 T4160 EHxxG3Z	2,700	2,000	2,500	1,900	2,378		
400	360	430	MVW01 0400 T4160 EHxxG3Z	3,300	2,500	3,000	2,300	2,882		
500	480	530	MVW01 0500 T4160 EHxxG3Z	4,200	3,200	4,100	3,100	3,603		
627	551	665	MVW01 0627 T4160 EHxxG3Z	5,300	4,000	4,600	3,500	4,518		
760	684	817	MVW01 0760 T4160 EHxxG3Z	6,500	4,900	5,800	4,400	5,476		
950	912	1,007	MVW01 0950 T4160 EHxxG3Z	8,100	6,100	7,900	5,900	6,845		
1,140	1,026	1,225	MVW01 1140 T4160 EHxxG3Z	9,700	7,300	8,800	6,600	8,214		
1,425	1,368	1,510	MVW01 1425 T4160 EHxxG3Z	12,300	9,200	11,700	8,800	10,268		
1,520	1,378	1,634	MVW01 1520 T4160 EHxxG3Z	13,000	9,800	11,700	8,800	10,952		
1,900	1,824	2,014	MVW01 1900 T4160 EHxxG3Z	16,000	12,300	15,000	11,800	13,690		
2,280	2,052	2,450	MVW01 2280 T4160 EHxxG3Z	18,000	14,000	17,000	13,000	16,428		
2,850	2,736	3,020	MVW01 2850 T4160 EHxxG3Z	24,000	18,000	22,000	17,000	20,535		
3,040	2,756	3,268	MVW01 3040 T4160 EHxxG3Z	25,000	19,000	22,000	17,000	21,904		
3,800	3,648	4,028	MVW01 3800 T4160 EHxxG3Z	32,000	24,000	30,000	23,000	27,380		

Notes: 1) Overload capacity:

MX = Maximum current/power without overload.

ND = Normal Duty: maximum current/power with 115% overload for 60 seconds, every 10 minutes.

HD = Heavy Duty: maximum current/power with 150% overload for 60 seconds, every 10 minutes.

2) The ratings apply at 40 °C ambient temperature and 1,000 meters above sea level.

3) Motor power is for 4P motor with 0,87 P.F. and 97% efficiency at full load.

4) For 2,300 V motors, please consider 3,300 V models using motor currents.

5) VSD input number pulses can be optimized according to the harmonics requirements.

6) The technical characteristics informed in the table above may changes without notice.

Models

MVW01 G3 - Air Cooled VSD – 5,500-6,000-6,300 V & 6,600-6,900 V

Output rated current			Product	Motor power				Frame size	Rect. pulses	Phase shifting transformer
ND	HD	Mx		ND		HD				Suggested power rate in ND
A				HP	kW	HP	kW			kVA
6,000 ~ 6,300 V										
58	55	62	MVW01 0058 T6300 EH60G3Z	700	500	600	450	C1	1x36	633
73	69	78	MVW01 0073 T6300 EH60G3Z	800	630	750	560			797
91	86	97	MVW01 0091 T6300 EH60G3Z	1,000	800	900	710			993
114	108	122	MVW01 0114 T6300 EH60G3Z	1,350	1,000	1,250	900			1,244
144	136	154	MVW01 0144 T6300 EH60G3Z	1,750	1,250	1,500	1,250			1,571
180	170	181	MVW01 0180 T6300 EH60G3Z	2,250	1,600	2,000	1,400			1,964
212	198	228	MVW01 0212 T6300 EH60G3Z	2,500	1,900	2,250	1,800			2,313
251	230	269	MVW01 0251 T6300 EH60G3Z	3,000	2,250	2,750	2,000			2,739
295	267	317	MVW01 0295 T6300 EH60G3Z	3,500	2,700	3,000	2,250			3,219
348	310	373	MVW01 0348 T6300 EH60G3Z	4,000	3,150	3,700	2,800			3,797
410	360	440	MVW01 0410 T6300 EH60G3Z	4,750	3,750	4,000	3,150			4,474
480	430	500	MVW01 0480 T6300 EH60G3Z	6,000	4,500	5,000	4,000			5,238
565	496	606	MVW01 0565 T6300 EH60G3Z	7,000	5,000	6,000	4,500			6,165
664	583	713	MVW01 0664 T6300 EH60G3Z	7,500	6,000	7,000	5,000			7,246
779	684	836	MVW01 0779 T6300 EH60G3Z	9,000	7,100	8,000	6,000	8,500		
912	817	950	MVW01 0912 T6300 EH60G3Z	11,000	8,000	10,000	7,100	9,952		
1,130	992	1,212	MVW01 1130 T6300 EH120G3Z	14,000	10,000	12,000	9,000	12,330		
1,328	1,166	1,426	MVW01 1328 T6300 EH120G3Z	15,000	12,000	14,000	10,000	14,491		
1,558	1,368	1,672	MVW01 1558 T6300 EH120G3Z	18,000	14,200	16,000	12,000	17,001		
1,824	1,634	1,900	MVW01 1824 T6300 EH120G3Z	22,000	16,000	20,000	14,200	19,903		
6,600 ~ 6,900 V										
54	50	58	MVW01 0054 T6900 EH60G3Z	700	500	600	450	C1	1x36	645
67	63	72	MVW01 0067 T6900 EH60G3Z	800	630	750	560			801
86	81	92	MVW01 0086 T6900 EH60G3Z	1,000	800	900	710			1,028
109	102	117	MVW01 0109 T6900 EH60G3Z	1,350	1,000	1,250	900			1,303
139	130	149	MVW01 0139 T6900 EH60G3Z	1,750	1,250	1,750	1,250			1,661
177	165	178	MVW01 0177 T6900 EH60G3Z	2,250	1,600	2,250	1,600			2,115
205	192	221	MVW01 0205 T6900 EH60G3Z	2,750	2,000	2,500	1,900			2,450
241	223	260	MVW01 0241 T6900 EH60G3Z	3,000	2,250	3,000	2,200			2,880
283	259	305	MVW01 0283 T6900 EH60G3Z	3,700	2,800	3,500	2,500			3,382
332	301	358	MVW01 0332 T6900 EH60G3Z	4,000	3,150	3,750	2,800			3,968
390	350	420	MVW01 0390 T6900 EH60G3Z	4,750	3,550	4,500	3,550			4,661
460	404	480	MVW01 0460 T6900 EH60G3Z	6,000	4,500	5,500	4,000			5,498
538	482	580	MVW01 0538 T6900 EH60G3Z	7,250	5,000	6,500	4,750			6,430
631	566	680	MVW01 0631 T6900 EH60G3Z	8,000	6,300	7,500	5,600			7,541
740	665	798	MVW01 0740 T6900 EH60G3Z	9,500	7,400	8,000	6,500	8,844		
874	767	912	MVW01 0874 T6900 EH60G3Z	11,000	8,000	10,000	7,100	10,445		
1,076	964	1,160	MVW01 1076 T6300 EH120G3Z	14,500	10,000	13,000	9,500	12,859		
1,262	1,132	1,360	MVW01 1262 T6300 EH120G3Z	16,000	12,600	15,000	11,200	15,082		
1,480	1,330	1,596	MVW01 1480 T6300 EH120G3Z	19,000	14,800	16,000	13,000	17,688		
1,748	1,534	1,824	MVW01 1748 T6300 EH120G3Z	22,000	16,000	20,000	14,200	20,891		

Notes: 1) Overload capacity:

MX = Maximum current/power without overload.

ND = Normal Duty: maximum current/power with 115% overload for 60 seconds, every 10 minutes.

HD = Heavy Duty: maximum current/power with 150% overload for 60 seconds, every 10 minutes.

2) The ratings apply at 40 °C ambient temperature and 1,000 meters above sea level.

3) Motor power is for 4P motor with 0.87 P.F. and 97% efficiency at full load.

4) For 5,500 V motors, please consider 6,300 V models using motor currents.

5) VSD input number pulses can be optimized according to the harmonics requirements.

6) The technical characteristics informed in the table above may change without notice.

Models

MVW01 G3 – Water Cooled VSD – 2,300 / 3,300 V & 4,160 V

Output rated current		Product	Motor power				Frame size	Rect. pulses	Phase shifting transformer
ND	HD		ND		HD				Suggested power rate in ND
A			HP	kW	HP	kW			kVA
3,300 V									
265	234	MVW01 0265 T3300 EHxxWCZ	1,625	1,300	1,430	1,040	1x12 or 1x18 or 1x24	1,525	
308	270	MVW01 0308 T3300 EHxxWCZ	1,950	1,430	1,755	1,300		1,775	
359	315	MVW01 0359 T3300 EHxxWCZ	2,275	1,625	1,950	1,456		2,075	
419	364	MVW01 0419 T3300 EHxxWCZ	2,700	2,080	2,400	1,820		2,400	
460	423	MVW01 0460 T3300 EHxxWCZ	2,960	2,260	2,730	2,100		2,800	
598	533	MVW01 0598 T3300 EHxxWCZ	3,900	2,925	3,250	2,600		3,425	
672	582	MVW01 0672 T3300 EHxxWCZ	4,550	3,250	3,900	2,860		3,850	
789	684	MVW01 0789 T3300 EHxxWCZ	5,005	3,900	4,680	3,380		4,525	
874	803	MVW01 0874 T3300 EHxxWCZ	5,600	4,300	5,180	3,970		5,300	
1,136	1,013	MVW01 1136 T3300 EHxxWCZ	7,150	5,200	5,850	4,615		6,500	
1,214	1,052	MVW01 1214 T3300 EHxxWCZ	7,800	5,850	6,500	5,200		6,950	
1,311	1,204	MVW01 1311 T3300 EHxxWCZ	8,550	6,350	7,900	5,900		7,950	
1,704	1,520	MVW01 1704 T3300 EHxxWCZ	10,400	8,190	9,425	7,280		9,750	
1,748	1,606	MVW01 1748 T3300 EHxxWCZ	11,250	8,400	10,340	7,710		10,000	
1,853	1,704	MVW01 1853 T3300 EHxxWCZ	11,930	8,900	10,970	8,180		10,600	
2,272	2,025	MVW01 2272 T3300 EHxxWCZ	14,300	10,400	13,000	9,230		13,000	
2,622	2,408	MVW01 2622 T3300 EHxxWCZ	16,880	12,560	15,500	11,500		15,900	
3,409	3,039	MVW01 3409 T3300 EHxxWCZ	20,800	16,250	19,500	14,560		19,500	
3,496	3,211	MVW01 3496 T3300 EHxxWCZ	22,500	16,700	20,670	15,400	21,175		
4,545	4,051	MVW01 4545 T3300 EHxxWCZ	29,250	20,800	26,000	18,200	25,975		
4,160 V									
235	211	MVW01 235 T4160 EHxxWCZ	1,950	1,430	1,690	1,300	1x12 or 1x18 or 1x24	1,700	
281	254	MVW01 281 T4160 EHxxWCZ	2,210	1,625	2,080	1,430		2,025	
312	285	MVW01 312 T4160 EHxxWCZ	2,530	1,900	2,320	1,720		2,250	
338	306	MVW01 338 T4160 EHxxWCZ	2,860	2,080	2,470	1,820		2,450	
382	345	MVW01 382 T4160 EHxxWCZ	3,250	2,340	2,860	2,080		2,750	
392	360	MVW01 392 T4160 EHxxWCZ	3,190	2,380	2,955	2,180		2,825	
429	390	MVW01 429 T4160 EHxxWCZ	3,510	2,600	3,250	2,470		3,100	
527	475	MVW01 527 T4160 EHxxWCZ	4,280	3,200	3,860	2,950		3,800	
550	495	MVW01 550 T4160 EHxxWCZ	4,550	3,430	4,035	3,080		3,975	
642	581	MVW01 642 T4160 EHxxWCZ	5,200	3,900	4,810	3,640		4,625	
729	658	MVW01 729 T4160 EHxxWCZ	5,850	4,550	5,200	4,095		5,250	
815	741	MVW01 815 T4160 EHxxWCZ	6,500	5,200	5,850	4,615		5,875	
963	871	MVW01 963 T4160 EHxxWCZ	7,800	6,100	7,040	5,550		6,950	
1045	945	MVW01 1045 T4160 EHxxWCZ	8,530	6,550	7,690	5,940		7,525	
1,086	984	MVW01 1086 T4160 EHxxWCZ	8,820	6,890	7,880	6,260		7,825	
1,223	1,112	MVW01 1223 T4160 EHxxWCZ	10,075	7,800	9,425	7,150		8,825	
1,413	1,284	MVW01 1413 T4160 EHxxWCZ	11,800	8,980	10,740	8,100		10,175	
1,568	1,424	MVW01 1568 T4160 EHxxWCZ	12,950	9,770	11,800	8,875		11,300	
1,630	1,482	MVW01 1630 T4160 EHxxWCZ	13,200	10,400	12,220	9,230		11,750	
1,927	1,742	MVW01 1927 T4160 EHxxWCZ	15,900	12,250	14,460	11,040		13,900	
2,090	1,899	MVW01 2090 T4160 EHxxWCZ	17,650	13,250	16,050	12,040	15,075		
2,200	1,988	MVW01 2200 T4160 EH40WCZ	18,280	14,000	16,415	12,600	15,850		
2,445	2,223	MVW01 2445 T4160 EH40WCZ	20,800	15,600	18,200	14,300	17,625		
3,136	2,851	MVW01 3136 T4160 EH40WCZ	26,650	19,880	24,150	18,150	22,600		
3,260	2,964	MVW01 3260 T4160 EH40WCZ	27,650	20,700	25,110	18,900	23,500		
4,180	3,800	MVW01 4180 T4160 EH40WCZ	35,440	26,500	32,200	24,100	30,125		

Notes: 1) Overload capacity:

MX = Maximum current/power without overload.

ND = Normal Duty: maximum current/power with 115% overload for 60 seconds, every 10 minutes.

HD = Heavy Duty: maximum current/power with 150% overload for 60 seconds, every 10 minutes.

2) The ratings apply at 40 °C ambient temperature and 1,000 meters above sea level.

3) Motor power is for 4P motor with 0.87 P.F. and 97% efficiency at full load.

4) For 2,300 V motors, please consider 3,300 V models using motor currents.

5) VSD input number pulses can be optimized according to the harmonics requirements.

6) The technical characteristics informed in the table above may changes without notice.

Models

MVW01 G3 - Water Cooled VSD – 5,500-6,000-6,300 V & 6,600-6,900 V

Output rated current		Product	Motor power				Frame size	Rect. pulses	Phase shifting transformer
ND	HD		ND		HD				Suggested power rate in ND
A			HP	kW	HP	kW			kVA
6,000 ~ 6,300 V									
276	257	MVW01 0276 T6300 EH60WCZ	3,250	2,470	2,925	2,340	C2W	1x36	3,025
326	299	MVW01 0326 T6300 EH60WCZ	3,900	2,925	3,575	2,600			3,550
384	347	MVW01 0384 T6300 EH60WCZ	4,550	3,510	3,900	2,925			4,200
452	403	MVW01 0452 T6300 EH60WCZ	5,200	4,095	4,810	3,640			4,950
533	468	MVW01 0533 T6300 EH60WCZ	6,175	4,875	5,200	4,095			5,825
624	559	MVW01 0624 T6300 EH60WCZ	7,800	5,850	6,500	5,200			6,825
735	645	MVW01 0735 T6300 EH60WCZ	9,100	6,500	7,800	5,850			8,025
863	758	MVW01 0863 T6300 EH60WCZ	9,750	7,800	9,100	6,500			9,425
1,013	889	MVW01 1013 T6300 EH60WCZ	11,700	9,230	10,400	7,800			11,050
1,186	1,062	MVW01 1186 T6300 EH60WCZ	14,300	10,400	13,000	9,230			12,950
1,248	1,118	MVW01 1248 T6300 EH120WCZ	15,600	11,700	13,000	10,400	2xC2W	13,625	
1,470	1,290	MVW01 1470 T6300 EH120WCZ	18,200	13,000	15,600	11,700	2xC3W	2x36	16,050
1,726	1,516	MVW01 1726 T6300 EH120WCZ	19,500	15,600	18,200	13,000			18,850
2,026	1,778	MVW01 2026 T6300 EH120WCZ	23,400	18,460	20,800	15,600			22,100
2,372	2,124	MVW01 2372 T6300 EH120WCZ	28,600	20,400	26,000	18,460			25,900
6,600 ~ 6,900 V									
267	250	MVW01 0267 T6900 EH60WCZ	3,575	2,600	3,250	2,470	C2W	1x36	3,200
313	290	MVW01 0313 T6900 EH60WCZ	3,900	2,925	3,900	2,860			3,750
368	337	MVW01 0368 T6900 EH60WCZ	4,810	3,640	4,550	3,250			4,400
432	391	MVW01 0432 T6900 EH60WCZ	5,200	4,095	4,875	3,640			5,175
507	455	MVW01 0507 T6900 EH60WCZ	6,175	4,615	5,850	4,615			6,075
598	525	MVW01 0598 T6900 EH60WCZ	7,800	5,850	7,150	5,200			7,150
699	627	MVW01 0699 T6900 EH60WCZ	9,425	6,500	8,450	6,175			8,350
820	736	MVW01 0820 T6900 EH60WCZ	10,400	8,190	9,750	7,280			9,800
962	865	MVW01 0962 T6900 EH60WCZ	12,350	9,620	10,400	8,450			11,500
1,140	1000	MVW01 1140 T6900 EH60WCZ	14,300	10,400	13,000	9,230			13,625
1,196	1,050	MVW01 1196 T6900 EH120WCZ	15,600	11,700	14,300	10,400	2xC2W	14,300	
1,398	1,254	MVW01 1398 T6900 EH120WCZ	18,850	13,000	16,900	12,350	2xC3W	2x36	16,725
1,640	1,472	MVW01 1640 T6900 EH120WCZ	20,800	16,380	19,500	14,560			19,600
1,924	1,730	MVW01 1924 T6900 EH120WCZ	24,700	19,244	20,800	16,900			23,000
2,272	1,994	MVW01 2272 T6900 EH120WCZ	28,600	20,800	26,000	18,460			27,175

Notes: 1) Overload capacity:

MX = Maximum current/power without overload.

ND = Normal Duty: maximum current/power with 115% overload for 60 seconds, every 10 minutes.

HD = Heavy Duty: maximum current/power with 150% overload for 60 seconds, every 10 minutes.

2) The ratings apply at 40 °C ambient temperature and 1,000 meters above sea level.











3) Motor power is for 4P motor with 0.87 P.F. and 97% efficiency at full load.

4) For 5,500 V motors, please consider 6,300 V models using motor currents.

5) VSD input number pulses can be optimized according to the harmonics requirements.

6) The technical characteristics informed in the table above may changes without notice.

Panel Dimensions and Weight – Air Cooled Version

MVW	Size	Height (mm)	Width (mm)	Depth (mm)	Weight (kg)
	A0	2,316	1,000 ²⁾	980	900
	A	2,190	2,400 ²⁾	960	1,560
	B	2,190	2,600 ²⁾	960	1,700
	C	2,190	4,160 ²⁾	960	2,700
	D	2,190	7,200 ²⁾	960	4,500
	E	2,190	8,480 ²⁾	960	5,000
	2xD	2,190	7,200 ¹⁾	1,920 ¹⁾	9,000
	2xE	2,190	8,480 ¹⁾	1,920 ¹⁾	10,000
	C1	2,306	1,800 ³⁾	1,200	1,700
	C2	2,223	3,300 ³⁾	1,000	3,100
	C3	2,223	7,480 ³⁾	1,000	6,200
	2xC3	2,223	7,480 ⁴⁾	2,000 ⁴⁾	12,400

Notes: 1) Back-to-back configuration. Approximated dimensions and weight for standard product 2x 12 pulses.











2) Approximated dimensions and weight for standard product 1x 12 pulses.

3) Approximated dimensions and weight for standard product 1x 36 pulses.

4) Back-to-back configuration. Approximated dimensions and weight for standard product 2x 36 pulses.

The technical characteristics informed in the table above may changes without notice.

Panel Dimensions and Weight – Water Cooled Version

MVV	Size	Height (mm)	Width (mm)	Depth (mm)	Weight (kg)
	AW	2,200	3,200 ¹⁾	1,040	2,500
	CW	2,200	4,500 ¹⁾	1,040	3,700
	DW	2,200	6,200 ¹⁾	1,040	5,100
	EW	2,200	7,400 ¹⁾	1,040	6,200
	2xDW	2,200	12,400 ²⁾	1,040	11,000
	2xEW	2,200	14,800 ¹⁾	1,040	13,200
	C2W	2,200	6,060 ³⁾	1,040	4,600
	C3W	2,200	8,760 ³⁾	1,040	6,800
	2xC2W	2,200	12,120 ³⁾	1,040	9,200
	2xC3W	2,223	17,520 ⁴⁾	1,040	13,600

Notes: 1) Approximated dimensions and weight for standard product 1x 12 pulses.
 2) Approximated dimensions and weight for standard product 2x 12 pulses.
 3) Approximated dimensions and weight for standard product 1x 36 pulses.
 4) Approximated dimensions and weight for standard product 2x 36 pulses.
 The technical characteristics informed in the table above may changes without notice.

Technical Data

Main power supply	Voltage	Standard up to 13.8 kV ²⁾	
	Frequency	50 or 60 Hz (± 3 Hz)	
	Phase unbalance	Less than 3 %	
	Cos ϕ (power factor)	Greater than 0.97	
	Power transformer	Phase-shifting transformer, dry type or oil type (12, 18, 24, 36 or 72 pulse)	
Control power supply	Voltage	Three-phase external supply: 110 to 690 V Internal voltage command: 110, 120 or 220 V via input internal command transformer	
	Frequency	50 or 60 Hz (± 3 Hz)	
	Phase unbalance	Less than 3%	
Output	Motor voltage	From 2.3 kV up to 6.9 kV	
	Switching device	High voltage IGBT (HV - IGBT)	
	Frequency range	0...120 Hz	
	Overload capacity	150 % for 60 seconds, every 10 minutes ($1.50 \times I_{rated}$ - HD)	
		115 % for 60 seconds, every 10 minutes ($1.15 \times I_{rated}$ - ND)	
Efficiency	Up to 99 % (up to 98 % including isolation transformer)		
Enclosure	Standard	IP21/IP41/IP42 options (air cooled versions)	
		IP54 (water cooled version)	
Ambient conditions	Temperature	0...40 °C (104 °F) Up to 50 °C (122 °F) with current derating of 2.5% for every 1 °C above 40 °C	
	Humidity	5...90% non-condensing	
	Altitude	0...1,000 m Up to 4,000 m (13,100 ft) with current derating of 10% for every 1,000 m above ¹⁾	
Control	Microprocessor	32 bits	
	Control method	SVM (Space Vector Modulation) and OPP™ (Synchronous Optimal Pulse Patterns)	
	Control types	Scalar (V/F), sensorless vector control and closed loop vector control	
Performance	Speed control	Scalar (V/F)	Regulation: 1% of rated speed with slip compensation Resolution: 1 rpm (HMI reference)
		Sensorless vector control	Speed regulation: 0.5% of rated speed Speed variation range: 1:100
		Closed loop vector control	Regulation: $\pm 0.01\%$ of rated speed with analog input of 14 bits $\pm 0.01\%$ of rated speed with digital reference (keyboard, serial, electronic potentiometer, multispeed) $\pm 0.1\%$ of rated speed with analog input of 10 bits (CC9)
Inputs	Analog	2 programmable differential inputs (10 bits): 0...10 V, 0...20 mA or 4...20 mA	
		1 programmable isolated input (10 bits): 0...10 V, 0...20 mA or 4...20 mA	
		1 programmable isolated input (10 bits): 0...10 V, 0...20 mA or 4...20 mA ¹⁾	
		1 programmable bipolar input (14 bits): -10 ... +10 V, 0...20 mA or 4...20 mA ¹⁾	
	Digital	8 programmable isolated inputs: 24 V dc 1 programmable isolated input: 24 V dc ¹⁾ 1 programmable isolated input: 24 V dc (for Motor PTC Thermistor) ¹⁾	
Outputs	Analog	2 programmable outputs (11 bits): 0...10 V	
		2 programmable isolated outputs (11 bits): 0...20 mA or 4...20 mA	
		2 programmable bipolar outputs (14 bits): -10...+10 V ¹⁾	
	Relay	2 programmable isolated outputs (11 bits): 0...20 mA or 4...20 mA ¹⁾	
Transistor	5 programmable outputs, form C contacts (NO/NC): 240 V ac, 1 A 2 programmable isolated outputs (open collector): 24 V dc, 50 mA ¹⁾		
Communication	Serial interface	RS232 (point-to-point) RS485, isolated, with EBA or EBB expansion boards (multi-point up to 30 drives) ¹⁾	
	Fieldbus network	Modbus-RTU, Modbus-TCP, CANopen, EtherNet/IP, Profibus-DP or DeviceNet	
Safety	Protections (fault log of the last 100 faults/alarms with date and time)	DC link overvoltage	Output short circuit
		DC link under voltage	Output ground fault
		VSD and motor overtemperature	External fault
		Output overcurrent	Self-diagnosis fault and programming error
		Motor overload (I x t)	Serial communication fault
		Dynamic braking resistor overload	Power supply phase loss
CPU/EPROM error (Watchdog)	Keypad connection fault		

Technical Data

Finishing	Color	Epoxy powder Gray RAL 7035	
Conformities/standards	Electromagnetic compatibility	EMC directive 89/336/EEC-Industrial Environment CEI standard - IEC61800-3 (EMC - Emission and Immunity)	
	CEI - IEC61800	Adjustable speed electrical power drive system Part 4 - general requirements Part 5 - safety requirements	
	Underwriters laboratories	UL 347, UL 347A	
	European commission	CE	
Touchscreen HMI	Commands	Start/stop, general functions programming	
		Increase/decrease speed	
		JOG, FWD/REV and local/remote	
	Monitoring	Speed reference (rpm)	Output current (A)
		Motor speed (rpm)	Output voltage (V)
		Speed proportional value (Ex: ft/min)	Drive status
		Output frequency (Hz)	Status of digital inputs
		DC link voltage (V)	Status of digital outputs
		Motor torque (%)	Status of relay outputs
		Output power (kW)	Analog inputs value
Motor running hours (h)	100 last faults with date and time		
VSD enabled hours (h)	Fault/alert messages		
Control features	Standard	Touchscreen HMI	
		Password to protect drive programming	
		LCD display language selection: English, Spanish, French, Deutsch and Portuguese	
		Fault auto-diagnosis and auto-reset	
		Parameters reset to factory or user default	
		Specific unit indication (Ex: l/s, t/h, %, etc.)	
		Slip compensation (V/Hz mode)	
		Manual and automatic torque boost - I x R (V/Hz mode)	
		Adjustable V/Hz curve (V/Hz mode)	
		Minimum and maximum set-points for speed, current, and DC-link voltage	
		Adjustable motor overload protection	
		Adjustable digital gain and offset for the analog inputs	
		Adjustable digital gain for the analog outputs	
		JOG +/-JOG - function (momentary speed increase/decrease)	
		Copy-paste/backup function (drive ↔ HMI)	
		Comparison functions for the digital outputs: N ¹ > Nx; N > Nx; N < Nx; N = 0; N = N ¹ ; Is > lx; Is < lx; T > Tx and T < Tx Where: N = Motor speed; N ¹ = Speed reference; Is = Output current and T = Motor torque	
		Linear and "S type" ramps and double ramp	
		Independent acceleration and deceleration ramps	
		Multi-speed function (up to 8 preset speeds)	
		Special indicators (hour meter and wattmeter)	
		Overlapped PID regulator (for automatic level, flow, pressure, and weight control)	
		Direction of rotation selection (FWD/REV)	
		Local/remote operation selection	
		Flying start function (restart with a spinning load)	
		Critical speed avoidance (skip up to 3 speeds)	
		Ride-through function (operation during momentary power loss)	
		Interface	Accessories
Communication boards			
SuperDrive kit with RS232 serial interface communication (drive ↔ PC)			
PLC2 integrated for PLC functions and logics			
HMI Touch screen with process information			

Notes: 1) Expansion board.

2) Other configurations, consult WEG.

The technical characteristics informed in the table above may changes without notice.

Testing Facilities

Every equipment manufactured is tested in our labs. This guarantees the performance and saves time during commissioning and start-up.

The tests of WEG MV VSD will be conducted in accordance with the following standards: IEC 60146-1, 61800-3, 61800-4 and 61800-5.

- Routine tests: Visual Inspection, insulation, dielectric voltage-withstand, light load, checking of auxiliary devices, checking the control equipment properties and checking the protective devices.
- Type tests: paint plan, rated load, temperature rise and efficiency / power losses.
- Especial tests: power factor, overload / overcurrent capability, harmonic distortion and ground fault test.

Routine tests, type tests and combined/string tests (VSD + Motor) can be performed in the same manufacturing plant. Please consult WEG for further information.



WEG Laboratories – Load tests in our facilities



Combined test (MV Incoming Switchgear + Phase-shifting Transformer + MV VSD + MV Motor)

Environmental Policy

Efficiency for us is to create sustainable solutions!

As global market keeps growing every day, as energy demands grow together. Be part of sustainable economy is our responsibility, this way WEG supplies smart and efficient solutions.

Medium voltage loads are commonly part of the largest consumers inside industries, the use of medium voltage VSDs for these applications most of the times can dramatically decrease the use of energy and power consumption, consequently reducing CO₂ and other emissions.

Guarantee **the lowest environmental impact** of **our products** and manufacturing processes by:



Being in compliance with the applicable **environmental legislation**



Improving continuously by establishing **environmental goals** and **targets**



Acting preventively with the aim of **protecting the environment**



Ecoefficient processes and products, saving **natural resources**

Certifications

ISO 50001:2011
ISO 14001:2014
ISO 9001:2008



Global presence is essential, as much as understanding your needs.

Global Presence

With more than 30,000 employees worldwide, WEG is one of the largest electric motors, electronic equipments and systems manufacturers. We are constantly expanding our portfolio of products and services with expertise and market knowledge. We create integrated and customized solutions ranging from innovative products to complete after-sales service.

WEG's know-how guarantees our **MVW01 medium voltage variable speed drive** is the right choice for your application and business, assuring safety, efficiency and reliability.



Availability is to have a global support network



Partnership is to create solutions that suit your needs



Competitive edge is to unite technology and innovation



Know More



High performance and reliable products to improve your production process.

MV Switchgears



MV Soft-Starter



Dry Phase Shifting Transformer



Oil Phase Shifting Transformer



Excellence is to provide a whole solution in industrial automation that improves our customers productivity.

Visit: www.weg.net

 youtube.com/wegvideos

For WEG's worldwide
operations visit our website



www.weg.net



AUTOMATION

 +55 47 3276.4000

 automacao@weg.net

 Jaraguá do Sul - SC - Brazil

Cod: 50019088 | Rev: 13 | Date (m/a): 03/2021.

The values shown are subject to change without prior notice.

The information contained is reference values.